



Harmony[®] K

Ø 16-22 cam switches

Quick access to product information

Get technical information about your product

References

Modicon TM3
I/O expansion modules for Modicon controllers
Analog I/O modules

Number and type of channels	Input range	Output range	Resolution	Input format (internal product)	Reference	Weight (kg)
2 voltage/current inputs	-15...+15 VDC 0...+15 VDC 0...25 mA, 4...25 mA	15.00V or 15.00V 4 sign	16.000 or 15.000 4 sign	0200-2 0200-3 0200-4 0200-5	TM3AI2H TM3AI2G TM3AI2K TM3AI2L	0.110 0.200 0.100 0.100
4 voltage/current inputs	-15...+15 VDC 0...+15 VDC 0...25 mA, 4...25 mA	15.00V or 15.00V 4 sign	16.000 or 15.000 4 sign	0200-2 0200-3 0200-4 0200-5	TM3AI4H TM3AI4G TM3AI4K TM3AI4L	0.100 0.200 0.100 0.100
4 differential temperature inputs (I, K, R, S, T, E, C, J) or 2 differential pressure (P) or 2 RTD (PT100, PT500, PT1000)	Thermopiles (I, K, R, S, T, E, C, J) Non-isolated Non-isolated	15.00V or 15.00V 4 sign	16.000 or 15.000 4 sign	0200-2 0200-3 0200-4 0200-5	TM3TI2 TM3TI4 TM3TIK TM3TIL	0.110 0.200 0.100 0.100
4 differential temperature inputs (I, K, R, S, T, E, C, J) or 2 differential pressure (P) or 2 RTD (PT100, PT500, PT1000)	Thermopiles (I, K, R, S, T, E, C, J) Non-isolated Non-isolated	15.00V or 15.00V 4 sign	16.000 or 15.000 4 sign	0200-2 0200-3 0200-4 0200-5	TM3TI2 TM3TI4 TM3TIK TM3TIL	0.110 0.200 0.100 0.100
8 voltage/current	-15...+15 VDC	15.00V or 15.00V 4 sign	16.000 or 15.000 4 sign	0200-2 0200-3 0200-4 0200-5	TM3AI8 TM3AI8G TM3AI8K TM3AI8L	0.110 0.200 0.100 0.100

Share Price Global (English)

Life Is On Schneider Electric

Search products, documents & more

My Products My Documents Partner Portal

PRODUCTS SOLUTIONS SERVICES SUPPORT ABOUT US

All products Industrial Automation and Control PLC, PAC and Dedicated Controllers Distributed Input/Output (I/O) Modules Modicon TMI

View all Modicon TMI

TM3AI2H

Module TM3 - 2 analog inputs high resolution

Show more characteristics >

Related Software >

Add to My Products

Compare

Product Datasheet User guide Catalogue CAD Document

Characteristics Documents and Downloads Technical FAQs Additional Information Dimensions Drawings

Main

range of product Modicon TMI

product or component type Analog input module

range compatibility Modicon M251

Each commercial reference presented in a catalog contains a hyperlink. Click on it to obtain the technical information of the product:

- Characteristics, Dimensions and drawings, Mounting and clearance, Connections and schemas, Performance curves
- Product image, Instruction sheet, User guide, Product certifications, End of life manual

Find your catalog

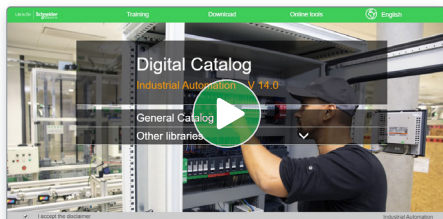

- > With just 3 clicks, you can access the Industrial Automation and Control catalogs, in both English and French
- > Consult digital automation catalogs at [Digi-Cat Online](#)

Industrial Automation

General Catalog

- Publications, Selection, PLCs & PACs
- Books, Catalogs & Interfaces
- Signaling Devices
- HMI (Terminals and Industrial PC)
- Sensors & RFID System
- Motor Starters and Load Management
- Components for Motor Starters
- Variable Speed Drives & Soft Starters
- Motor Control & Robotics
- Interface, Measurement & Control Relays
- PLC, PAC & other Controllers

Publications, Selection, PLCs & PACs

Home 288

Product Selector

360°

- Up-to-date catalogs
- Embedded product selectors, 360° pictures
- Optimized search by commercial references

Select your training



- > Find the right [Training](#) for your needs on our Global website
- > Locate the training center with the selector tool, using this [link](#)

Training and courses

Whether you are a professional, a student or a beginner, Schneider Electric offers you the right training and courses to improve your skills, increase your productivity and ensure the safety of your employees.

Training by domain of expertise

- Electrical Installation and Safety
- Data Center
- Industrial Automation

General contents

General Presentation	page 2
Selection guide	page 4
■ Functions panorama	page 6
Complete switches, 10 A	
■ General	page 8
■ Front mounting by Ø 16 or 22 mm hole, with 30 x 30 mm front plate	page 9
□ Switches and stepping switches	page 9
□ Changeover switches	page 11
□ Voltmeter and ammeter switches	page 13
Complete switches, 12 and 20 A	
■ General	
□ Complete switches and adaptable sub-assemblies, 12 and 20 A	page 14
■ Front mounting “multi-fixing” or by Ø 22 mm hole, with 45 x 45 mm front plate	
□ Switches	page 18
□ Stepping switches	page 21
□ Reversing and changeover switches	page 27
□ Ammeter switches	page 28
□ Voltmeter switches	page 30
Adaptable sub-assemblies, 12 and 20 A	
■ Bodies (contact blocks + fixing plate)	
□ Switches	page 32
□ Changeover switches	page 36
□ Reversing switches	page 37
□ Encoded output switches	page 39
□ Paralleling switches	page 42
□ Stepping switches	page 43
□ Ammeter switches	page 53
□ Voltmeter switches	page 54
□ Reversing switches	page 57
□ Star-delta switches and reversing star-delta switches	page 58
□ Pole change switches and reversing pole change switches	page 59
■ Operating heads	
□ For “multi-fixing” or Ø 22 mm hole, front mounting bodies	page 61
□ For 4 hole, rear mounting bodies	page 62
■ Legends	
□ For “multi-fixing” heads	page 63
□ For Ø 22 mm hole mounting heads with plastic bezel	page 64
□ For Ø 22 mm hole mounting heads with chromium plated metal bezel	page 65
□ Legend holders for heads	page 66
□ Separate components and accessories	page 67
Complete switches, 12 A with key operated lock	
■ Front mounting by 6 screws Ø 5.2 mm, with 55 x 100mm front plate	
□ Stepping switches, 2 to 5 step	page 69
□ Changeover switches	page 73
Switches, 10 and 16 A, mounted in plastic enclosure	
■ OFF-ON switches	page 74
■ Complete switches, 32 to 150 A	
■ General	page 75
■ With 64 x 64 mm front plate (32 to 63 A ratings) and 88 x 88 mm front plate (115 and 150 A ratings)	
□ Switches	page 76
□ Changeover switches	page 78
□ Star-delta and reversing star-delta switches	page 79
□ Pole change and reversing switches	page 80
Index	
■ Product reference index	page 81

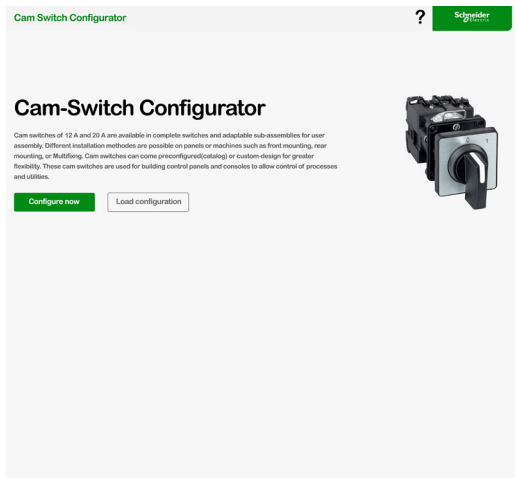

A cam switch configurator is a tool used to configure cam switches. The configurator allows the user to specify the desired specifications and characteristics of the cam switch, such as the number of poles and contacts, the type of actuator, and the mounting style. The configurator then generates a unique code that can be used to order the switch with the specified specifications.

This cam switch configurator has a user-friendly interface that makes it easy to specify the desired specifications. The user can input the desired specifications using selection menus, text boxes, or other input methods. This configurator also has diagrams or illustrations that help the user understand how the different specifications and options will affect the overall performance of the switch.

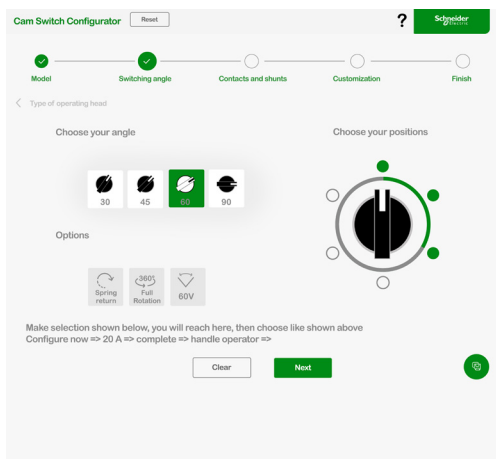

Using a cam switch configurator can

- Ensure that the customer orders the correct switch for their specific application.
- Help customers easily specify the desired specifications and see how they will affect the switch's performance
- Help to save time and reduce the risk of ordering a switch that is not suitable for the application.

How to access

<https://camswitconfig-prod.se.com/>

Harmony K

Cam switches

Type K

Applications
Functions
Off-On/On-Off switches
Stepping switches
Changeover switches
Measurement switches
Reversing switches
Reversing star-delta switches
Pole change switches

Used in building control panels and consoles, type K cam switches allow control of processes and utilities in industry and buildings and direct control for simple machines.

1 to 4-pole	1 to 6-pole
2 to 4-position, 1 and 2-pole	2 to 12-position, 1 to 4-pole
1 to 4-pole	1 to 5-pole
Voltmeter and ammeter	Voltmeter and ammeter
–	2 and 3-pole
–	–
–	2 and 3-speed



Conventional rated thermal current (Ith)	10 A	12 A
Rated insulation voltage (Ui)	440 V	690 V
Electrical operating characteristics	AC-15 - A300 240 V - 3 A	AC-3 - 3-phase 230 V - 1.1 kW - 4.6 A AC-15 230 V - 3 A
Front plate degree of protection	IP 65	IP 40 IP 65 (with seal)
Product composition	Complete switches	Complete switches Adaptable sub-assemblies Special products (Consult our Customer Care Centre)
Compatibility	Ø 16 and Ø 22 control and signaling units	Ø 22 control and signaling units
Fixing	Front mounting Single Ø 16 or Ø 22 hole	Multi-fixing Single Ø 22 hole
	Rear mounting –	Screw fixing , 4 holes on 36 mm/1.42 in. centres
Front plate dimensions (mm)	30 x 30 mm/1.18 x 1.18 in.	45 x 45 mm/1.77 x 1.77 in. 60 x 60 mm/2.36 x 2.36 in. (adaptable sub-assemblies)
Operating heads	Black standard handle Metallic legend, black marking	Black and red standard and long handles Key operator Metallic head Metallic legend with black marking or black legend with white marking
Approvals	cULus EN/IEC 60947-3 EN/IEC 60947-5-1	UL-CSA EN/IEC 60947-3 EN/IEC 60947-5-1
Type	Type K10	Type K1/K2
Cam switch model	K10●	K1●

1 to 6-pole	1 to 6-pole
2 to 12-position, 1 to 4-pole	–
1 to 5-pole	1 to 4-pole
–	–
2 and 3-pole	2 and 3-pole
Star-delta	Star-delta
2 and 3-speed	2-speed



20 A	32 A	50 A	63 A	115 A	150 A
690 V	690 V	690 V	690 V	690 V	690 V
AC-3 - 3-phase 230 V - 2.2 kW - 8.3 A AC-15 230 V - 4 A	AC-3 - 3-phase 230 V - 5.5 kW AC-15 230 V - 14 A	AC-3 - 3-phase 230 V - 7.5 kW AC-15 230 V - 16 A	AC-3 - 3-phase 230 V - 11 kW	AC-3 - 3-phase 230 V - 15 kW	AC-3 - 3-phase 230 V - 22 kW
IP 40 IP 65 (with seal)	IP 40				
Complete switches Adaptable sub-assemblies Special products (Consult our Customer Care Centre)	Complete switches				
Ø 22 control and signaling units					
Multi-fixing Single Ø 22 hole	By 4 holes on 48 mm / 1.89 in. centres			By 4 holes on 68 mm / 2.68 in. centres	
Screw fixing , 4 holes on 36 mm/1.42 in. centres	Screw fixing , 4 holes on 48 mm/1.89 in. centres			Screw fixing , 4 holes on 68 mm/2.68 in. centres	
45 x 45 mm/1.77 x 1.77 in. 60 x 60 mm/2.36 x 2.36 in. (adaptable sub-assemblies)	64 x 64 mm/2.52 x 2.52 in.			88 x 88 mm/3.46 x 3.46 in.	
Black and red standard and long handles Key operator Metallic head Metallic legend with black marking or black legend with white marking	Black standard handle Metallic legend, black marking				
UL-CSA EN/IEC 60947-3 EN/IEC 60947-5-1	cULus EN/IEC 60947-3				
K2●	Type K30...K150		K30●	K50●	K63●
			K115●	K150●	

Functions		Complete switches 10 A
Switches	with 60° switching angle	See pages 9
	with 45° switching angle	–
	with 90° switching angle	–
	ON-OFF with spring return from 30° to “0” position	–
	OFF-ON with spring return from 30° to “0” position	–
	OFF-ON with spring return from 120° to 90°	–
	OFF-ON with spring return from 30° and from 330° to “0” position	–
	OFF-ON with 45° switching angle	–
	OFF-ON with momentary-contact function	–
	paralleling with “0” position	–
	OFF-ON changeover with spring return from 240° to 270° and from 120° to 90°	–
	Stepping switches	single-pole with or without “0” position
2-pole with or without “0” position		10, 11
2 to 5 step, single-pole, with or without “0” position		–
2 to 5 step, 2-pole, with or without “0” position		–
2 and 3 step, 3-pole, with or without “0” position		–
2 to 11 step, single-pole, with “0” position		–
2 to 12 step, single-pole, without “0” position		–
2 to 6 step, 2-pole, with or without “0” position		–
2 to 6 step, 3-pole, with or without “0” position		–
2 to 5 step, 4-pole, with or without “0” position		–
2 and 3 step, with “0” position + left-hand position		–
3 step, without “0” position		–
4 step, 4-pole, without “0” position		–
2 step, with “0” position		–
3 step, 2-pole, with “0” position		–
5 step, 2-pole, with “0” position	–	
Changeover switches	spring return to “0” position	11
	with or without “0” position	12
	1 to 4-pole with “0” position	–
	1 to 4-pole without “0” position	–
	1-pole, 2-pole, 3-pole with “0” position	–
	star-delta and reversing star-delta	–
	pole change	–
Voltmeter switches	with “0” position	13
	without “0” position	–
Ammeter switches	with “0” position	13
	without “0” position	–
Selector switches	BCD encoded output, with “0” position	–
	BCD encoded output, without “0” position	–
	multi-circuit	–
	star-delta and reversing star-delta	–
Reversing switches	with “0” position	–
	with spring return from 330° and from 30° to “0” position	–
	with spring return from 315° and from 45° to “0” position	–
	with spring return from 240° to 270° and from 120° to 90°	–
	with momentary-contact function	–
Pole change switches	for 2-speed motors	–
	for 3-speed motors	–
Start selector switches	3-position with “0” position	–
	4-position with “0” position	–
Starting switches	star-delta and reversing star-delta	–
	pole change	–

Complete switches 12 and 20 A	Complete switches 12 A, with key operated lock	Adaptable sub-assemblies 12 and 20 A	Complete switches 32 to 150 A
See pages	See pages	See pages	See pages
-	-	-	76
18	-	32	-
18	-	33	77
19	-	34	-
19	-	34	-
20	-	34	-
20	-	35	-
-	-	34	-
-	-	35	-
-	-	42	-
-	-	35	-
-	-	-	-
-	-	-	-
21, 22	-	-	-
23, 24	-	-	-
25, 26	-	-	-
-	-	43, 44	-
-	-	45, 46	-
-	-	47, 48	-
-	-	49, 50	-
-	-	51, 52	-
-	-	56	-
-	69	-	-
-	70	-	-
-	71	-	-
-	72	-	-
-	72	-	-
-	-	-	-
-	-	-	-
-	-	36, 37	78
27	-	-	-
27	-	-	-
-	73	-	-
-	-	58, 59	-
-	-	60	79
30	-	54	-
30	-	54	-
28	-	53	-
28	-	53	-
-	-	39, 40	-
-	-	40, 41	-
-	-	-	-
-	-	58	-
-	-	38, 57	80
-	-	57	-
27	-	38	-
-	-	38	-
-	-	38	-
-	-	59, 60	80
-	-	-	-
-	-	-	-
-	73	-	-
-	-	-	79
-	-	-	80

Cam switches

Complete switches, 10 A

The range of K10 cam switches (10 A rating) comprises only complete switches. These products are more specifically designed for process control applications:

- compact size,
- easy to integrate with other $\varnothing 16 \text{ mm}/0.63 \text{ in.}$ and $\varnothing 22 \text{ mm}/0.87 \text{ in.}$ units,
- selection functions.

Complete switches

- switches
- stepping switches
- changeover switches
- voltmeter switches
- ammeter switches

Front mounting

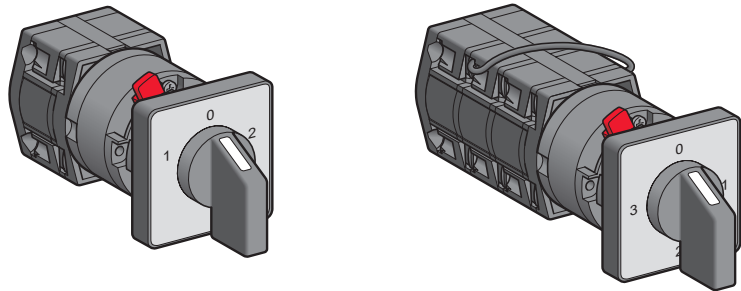

By $\varnothing 16.3 \text{ mm}/0.64 \text{ in.}$ or $\varnothing 22.3 \text{ mm}/0.88 \text{ in.}$ hole

Mounting

$\varnothing 16$ or $\varnothing 22$ hole fixing

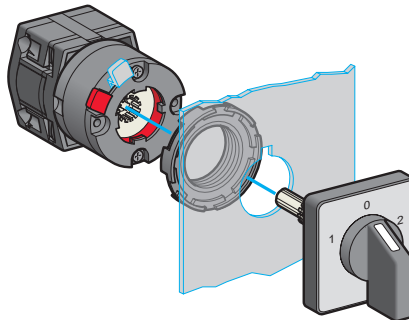

Locking/unlocking of the body-head assembly by spigot

$\varnothing 16$ hole fixing

$\varnothing 22$ hole fixing

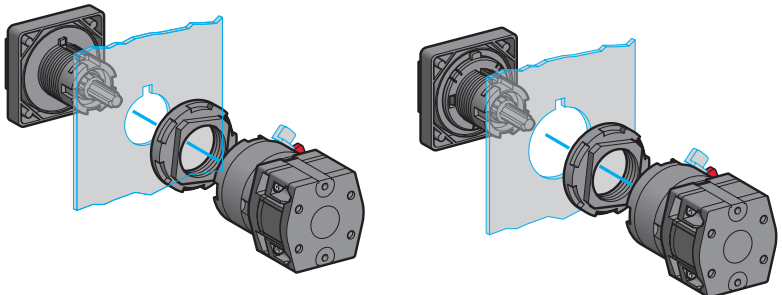

Cam switches

Complete switches, 10 A

Front mounting by Ø 16 or Ø 22 mm hole

With 30 x 30 mm front plate



K10B002ACH

Switches with 60° switching angle

Wiring diagram and switching programme	Marking and switch position	Number of poles	Reference	Weight kg/lb
		1	K10A001ACH	0.030/0.066
		2	K10B002ACH	0.035/0.077
		3	K10C003ACH	0.045/0.099
		4	K10D004ACH	0.045/0.099

Stepping switches, single-pole, with "0" position

Wiring diagram and switching programme	Marking and switch position	Number of steps	Reference	Weight kg/lb
		2 + "0" position	K10B002QCH	0.035/0.077
		3 + "0" position	K10C003QCH	0.045/0.099
		4 + "0" position	K10D004QCH	0.045/0.099



K10D004QCH

Cam switches

Complete switches, 10 A

Front mounting by Ø 16 or Ø 22 mm hole

With 30 x 30 mm front plate

550259



K10D012QCH

Stepping switches, 2-pole, with "0" position

Wiring diagram and switching programme	Marking and switch position	Number of steps	Reference	Weight kg/lb

Cam switches

Complete switches, 10 A

Front mounting by Ø 16 or Ø 22 mm hole

With 30 x 30 mm front plate

Stepping switch, 2-pole, without "0" position

Wiring diagram and switching programme	Marking and switch position	Number of steps	Reference	Weight kg/lb
--	-----------------------------	-----------------	-----------	--------------

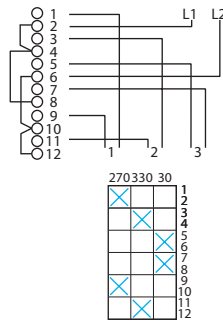

3 [K10F013NCH](#) 0.055/0.121



Changeover switch with spring return to "0" position

Wiring diagram and switching programme	Marking and switch position	Number of poles	Reference	Weight kg/lb
--	-----------------------------	-----------------	-----------	--------------

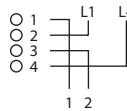

1 [K10B006TCH](#) 0.035/0.077



550280



K10B006TCH

Cam switches

Complete switches, 10 A

Front mounting by Ø 16 or Ø 22 mm hole

With 30 x 30 mm front plate



K10F003UCH

Changeover switches with "0" position

Wiring diagram and switching programme	Marking and switch position	Number of poles	Reference	Weight kg/lb
		1	K10B001UCH	0.035/0.077
		2	K10D002UCH	0.045/0.099
		3	K10F003UCH	0.055/0.121
		4	K10H004UCH	0.065/0.143

Changeover switches without "0" position

		1	K10B011UCH	0.035/0.077
		2	K10D012UCH	0.045/0.099
		3	K10F013UCH	0.055/0.121
		4	K10H014UCH	0.065/0.143

Cam switches

Complete switches, 10 A

Front mounting by Ø 16 or Ø 22 mm hole

With 30 x 30 mm front plate

550262



K10F027MCH

Voltmeter switches

For measurements between 3 phases and between 1 phase and neutral

Wiring diagram and switching programme

Marking and switch position

Reference

Weight kg/lb

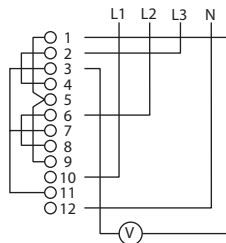

K10F027MCH 0.055/0.121

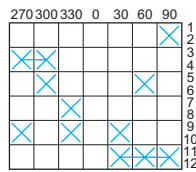

For measurements between 3 phases, with "0" position

Reference

Weight kg/lb

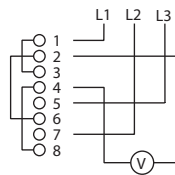

K10F024MCH 0.045/0.099

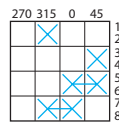

Ammeter switches

For 3 circuits, with "0" position

Reference

Weight kg/lb

550263



K10F003MCH

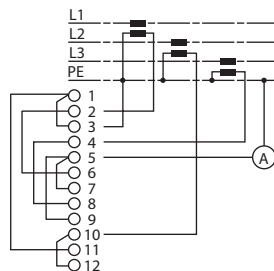

K10F003MCH 0.055/0.121

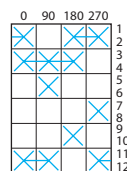

Cam switches

Complete switches and adaptable sub-assemblies, 12 and 20 A

The cam switch range comprises the equally dimensioned and similar looking products of the K1 (12 A rating) series and K2 (20 A rating) series. Both series feature complete switches and adaptable sub-assemblies for user assembly.

Complete switches

Front mounting

- switches
- stepping switches (2 to 5 step)
- reversing and 1 to 4-pole changeover switches
- ammeter and voltmeter switches

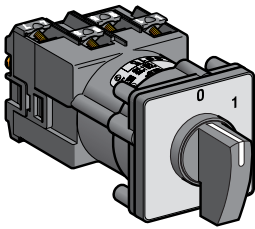

"Multi-fixing"

K1●●●●●H, K2●●●●●H
See [pages 18 to 25](#)

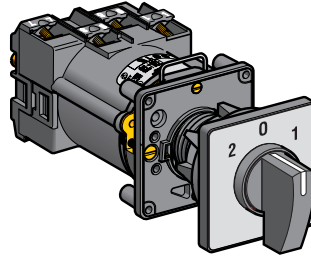

By Ø 22 mm/0.87 in. hole

K1●●●●●H, K2●●●●●H
See [pages 18 to 25](#)

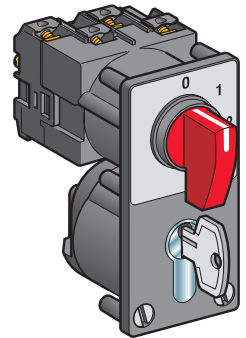

Front mounting by 6 screws
Ø 5.2 mm/0.20 in. and
55 x 100 mm/2.16 x 3.94 in.
front plate

K1●●●●●Z●
See [pages 69 to 73](#)

Switches for user assembly

Front mounting

Body sub-assembly

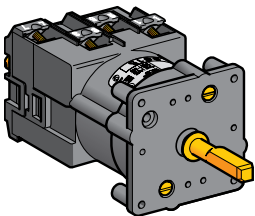

Head sub-assembly

- With 45 x 45 mm/1.77 x 1.77 in. front plate and 35 mm/1.38 in. handle

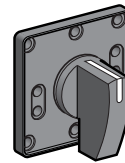

"Multi-fixing"

K1●●●●●L, K2●●●●●LL
See [pages 32 to 60](#)

With blank legend

K●G3H
See [page 61](#)

With marked legend

KCG3H
See [page 61](#)

Without legend

KDG3H
See [page 61](#)

Head sub-assembly

- With 45 x 45 mm/1.77 x 1.77 in. front plate, 35 mm/1.38 in. handle and padlocking device

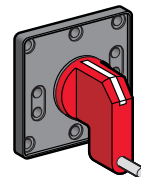

With marked legend

KCG3Y
See [page 61](#)

Without legend

KDG3Y
See [page 61](#)

Cam switches

Complete switches and adaptable sub-assemblies, 12 and 20 A

Switches for user assembly (continued)

Front mounting (continued)

Body sub-assembly

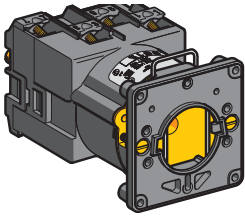

With Ø 22 mm/0.87 in. hole

K1●●●●●●, K2●●●●●●L

See [pages 32 to 60](#)

Head sub-assembly

■ With 45 x 45 mm/ 1.77 x 1.77 in. front plate and 35 mm/1.38 in. handle

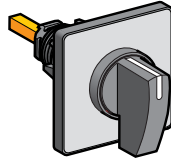

With blank legend

K●C1H

See [page 61](#)

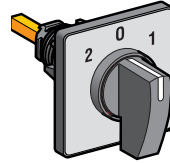

With marked legend (1)

K●C1●●

See [page 61](#)

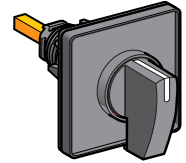

Without legend

KDC1●●

See [page 61](#)

Head sub-assembly

■ With 45 x 45 mm/1.77 x 1.77 in. front plate and key operator

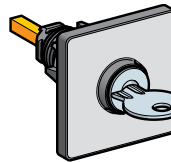

With blank legend

K●C1●

See [page 61](#)

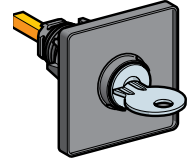

Without legend

KDC1●

See [page 61](#)

Head sub-assembly

■ With 60 x 60 mm/2.36 x 2.36 in. front plate and 42 mm/1.65 in handle

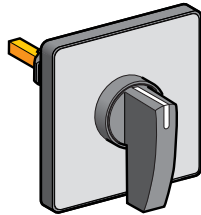

With blank legend

K●D1H

See [page 61](#)

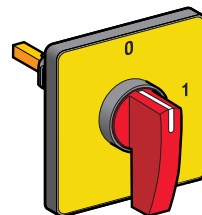

With marked legend

KCD1MH

See [page 61](#)

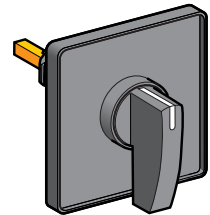

Without legend

KDD1H

See [page 61](#)

Head sub-assembly

■ With 60 x 60 mm/2.36 x 2.36 in. front plate and key operator

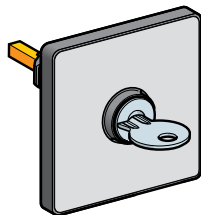

With blank legend

K●D1●

See [page 62](#)

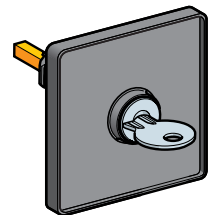

Without legend

KDD1●

See [page 62](#)

Head sub-assembly

■ Circular with plastic bezel



Key operator

K●A1●

See [page 62](#)

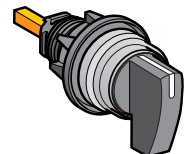

35 mm/1.38 in. handle

K●A1H

See [page 62](#)

(1) With or without padlocking device.

Cam switches

Complete switches and adaptable sub-assemblies, 12 and 20 A

Switches for user assembly (continued)

Front mounting (continued)

Body sub-assembly

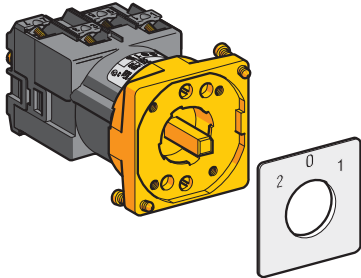

With Ø 22 mm/0.87 in. hole and metal mounting plate

K1●●●●●K, K2●●●●●X

See [pages 32 to 60](#)

Head sub-assembly

- Circular with metal bezel



Standard handle

KAXZ1M1●

See [page 62](#)



Long handle

KAXZ1C1●

See [page 62](#)



Key operator

KAXZ1S1●●

See [page 62](#)

Rear mounting

Body sub-assembly

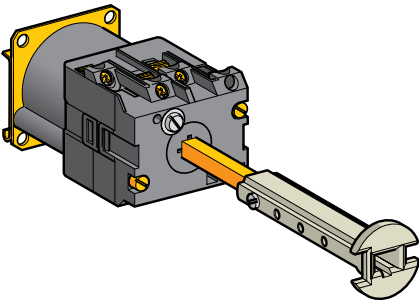

With 4 holes

K1●●●●●, K2●●●●●

See [pages 32 to 60](#)

Head sub-assembly

- With 45 x 45 mm/1.77 x 1.77 in. front plate and 35 mm/1.38 in. handle

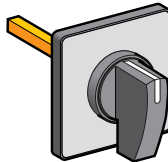

With blank legend

KoE1H

See [page 62](#)

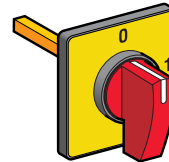

With marked legend (1)

KCE1●

See [page 62](#)

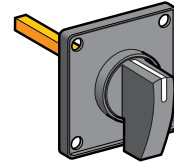

Without legend

KDE1●

See [page 62](#)

Head sub-assembly

- With 60 x 60 mm/2.36 x 2.36 in. front plate and 42 mm/1.65 in handle

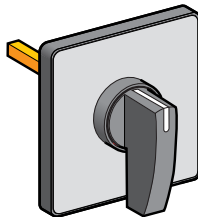

With blank legend

KoF1H

See [page 62](#)

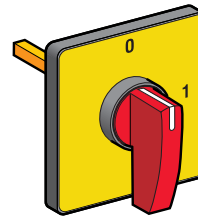

With marked legend

KCF1MH

See [page 62](#)

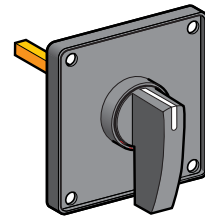

Without legend

KDF1H

See [page 62](#)

(1) With or without padlocking device.

Accessories

Various accessories complement the K1 - K2 cam switch range: legends, legend holders, terminal covers, seals, etc. See [pages 63 to 68](#).

Switches with specific schemes

If you cannot find a standard switching programme listed in this catalogue to suit your application, please consult our Customer Care Centre.

Cam switches

Complete switches and adaptable sub-assemblies, 12 and 20 A

The cam switches are available to suit various mounting and fixing methods.

Fixing

Front mounting

By means of "multi-fixing" front plate, using 2 or 4 screws

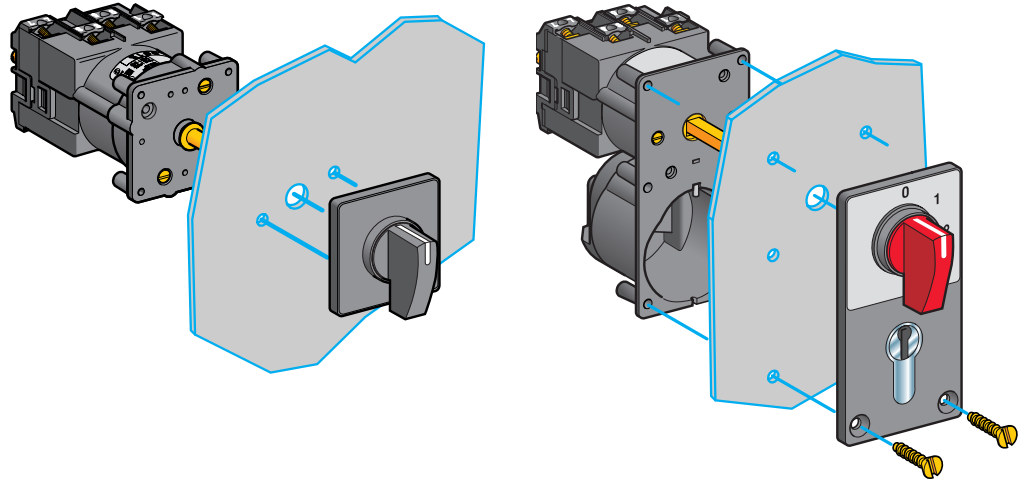
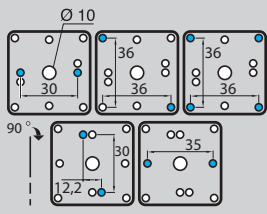

The "multi-fixing" concept enables the switch to be panel mounted using the most commonly used fixing centre dimensions. See drawing to left.

Fixing by 6 screws \varnothing 5.2 mm and 55 x 100 mm front plate.

By means of single \varnothing 22 mm/0.87 in. hole

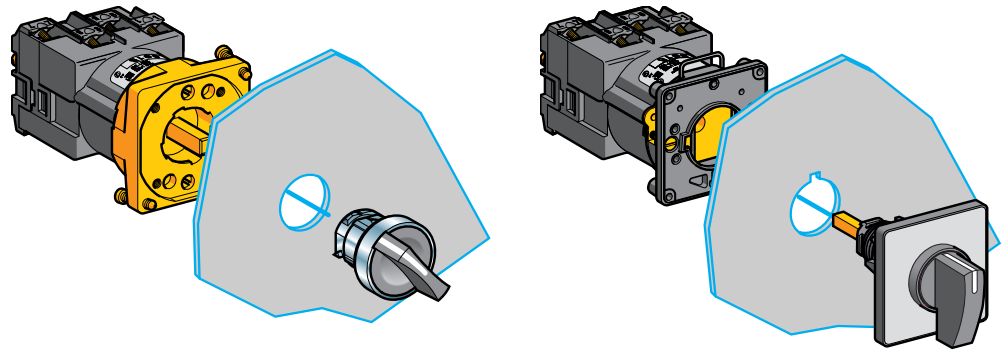

\varnothing 22.5 mm cut-out.
Head attaches to plate using 1/4 turn bayonet locking and secured on panel by 2 needle screws.

\varnothing 22.5 mm cut-out with anti-rotation notch.
Head clips into body and secured on panel by fixing nut.

Rear mounting

By means of 4 holes

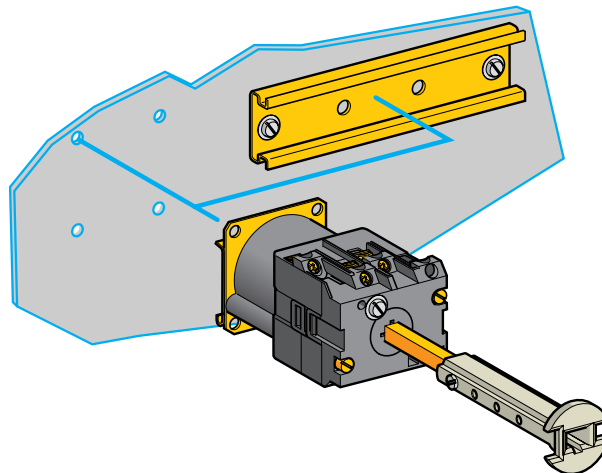

Switch can be directly mounted on backplate using 4 screws.
For DIN rail mounting, an adaptor is available as an accessory. See [page 68](#).

Cam switches

Complete switches, 12 and 20 A

Front mounting, "multi-fixing" or by Ø 22 mm hole

With 45 x 45 mm front plate, 35 mm handle and metallic legend with black marking

Switches with 45° switching angle

Wiring diagram and switching programme	Marking and switch position	Front mounting method	Number of poles	Thermal current (Ith)	Reference	Weight			
				A			kg/lb		
		"Multi-fixing"	1	12	K1A001ALH	0.103/0.227			
				20	K2A001ALH	0.103/0.227			
			2	12	K1B002ALH	0.113/0.249			
				20	K2B002ALH	0.113/0.249			
			3	12	K1C003ALH	0.133/0.293			
				20	K2C003ALH	0.133/0.293			
			4	20	K2D004ALH	0.138/0.304			
				20	K2E005ALH	0.158/0.348			
				20	K2F006ALH	0.168/0.370			
					By Ø 22 mm/ 0.87 in. hole	1	12	K1A001ACH	0.123/0.271
							20	K2A001ACH	0.123/0.271
						2	12	K1B002ACH	0.133/0.293
	20	K2B002ACH				0.133/0.293			
3	12	K1C003ACH				0.153/0.337			
	20	K2C003ACH				0.153/0.337			
6	12	K1F006ACH				0.188/0.414			
	20	K2F006ACH				0.188/0.414			

Switches with 90° switching angle

		"Multi-fixing"	2	12	K1B1002HLH	0.130/0.287
				20	K2B1002HLH	0.130/0.287
			3	20	K2C003HLH	0.135/0.298
			4	20	K2D004HLH	0.140/0.309
		By Ø 22 mm/ 0.87 in. hole	2	12	K1B1002HCH	0.150/0.331
				20	K2B1002HCH	0.150/0.331
			3	12	K1C003HCH	0.155/0.342
				20	K2C003HCH	0.155/0.342

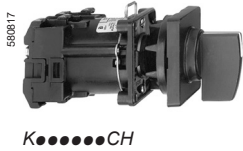





Cam switches

Complete switches, 12 and 20 A

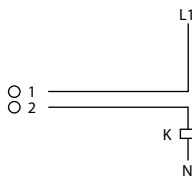
Front mounting, "multi-fixing" or by Ø 22 mm hole

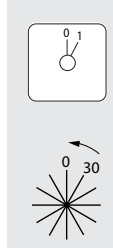
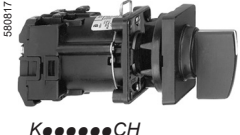
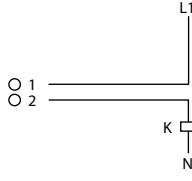
With 45 x 45 mm front plate, 35 mm handle and metallic legend with black marking

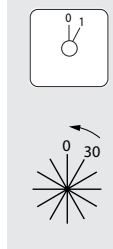
ON-OFF switches with spring return from 30° to "0" position						
Wiring diagram and switching programme	Marking and switch position	Front mounting method	Number of poles	Thermal current (Ith)	Reference	Weight
				A		kg/lb
 <p>590818 K.....LH</p>  		"Multi-fixing"	1	12	K1A002TLH	0.105/0.231
OFF-ON switches with spring return from 30° to "0" position						
 <p>590817 K.....CH</p>  		By Ø 22 mm/ 0.87 in. hole	1	12	K1A001TCH	0.125/0.275
				20	K2A001TCH	0.125/0.275

Cam switches

Complete switches, 12 and 20 A

Front mounting, "multi-fixing" or by Ø 22 mm hole

With 45 x 45 mm front plate, 35 mm handle and metallic legend with black marking

OFF-ON switches with spring return from 30° and from 330° to "0" position



Wiring diagram and switching programme

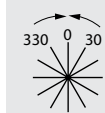
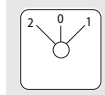
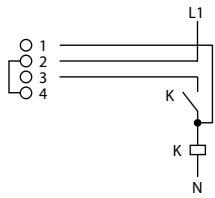

"Multi-fixing" 1 20 [K2B004TLH](#) 0.115/0.253

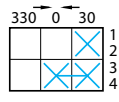
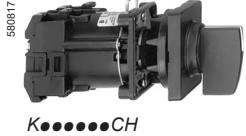









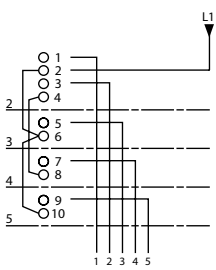

By Ø 22 mm/
0.87 in. hole 1 20 [K2B004TCH](#) 0.135/0.298

Cam switches

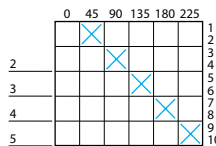
Complete switches, 12 and 20 A

Front mounting, "multi-fixing" or by Ø 22 mm hole

With 45 x 45 mm front plate, 35 mm handle and metallic legend with black marking





Stepping switches (2 to 5 step), single-pole, with "0" position								
Wiring diagram and switching programme	Marking and switch position	Front mounting method	Thermal current (Ith)	Reference	Weight			
			A		kg/lb			
 <p>560018 K●●●●●LH</p>		 	"Multi-fixing"					
			2 step + "0"					
 <p>560017 K●●●●●CH</p>		 	"Multi-fixing"					
			3 step + "0"					
			12			K1C003QLH	0.135/0.298	
			20			K2C003QLH	0.135/0.298	
			By Ø 22 mm/ 0.87 in. hole			12	K1C003QCH	0.155/0.342
			20			K2C003QCH	0.155/0.342	
			4 step + "0"					
			12			K1D004QLH	0.140/0.309	
20			K2D004QLH	0.140/0.309				
By Ø 22 mm/ 0.87 in. hole			12	K1D004QCH	0.160/0.353			
	 	"Multi-fixing"						
		5 step + "0"						
		12			K1E005QLH	0.160/0.353		
		20			K2E005QLH	0.160/0.353		
By Ø 22 mm/ 0.87 in. hole			12	K1E005QCH	0.180/0.397			

Cam switches

Complete switches, 12 and 20 A

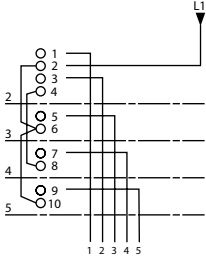
Front mounting, "multi-fixing" or by Ø 22 mm hole

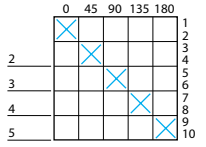
With 45 x 45 mm front plate, 35 mm handle and metallic legend with black marking









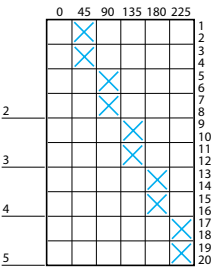

Stepping switches (2 to 5 step), single-pole, without "0" position						
Wiring diagram and switching programme	Marking and switch position	Front mounting method	Thermal current (Ith)	Reference	Weight	
			A		kg/lb	
 <p>560818 K●●●●●LH</p>			2 step 12	K1B002NCH	0.135/0.298	
			By Ø 22 mm/ 0.87 in. hole			
 <p>560817 K●●●●●CH</p>			3 step 12	K1C003NLH	0.135/0.298	
			"Multi-fixing"			20
			By Ø 22 mm/ 0.87 in. hole	12	K1C003NCH	0.155/0.342
			4 step 12	K1D004NLH		
			"Multi-fixing"		12	K1D004NCH
			By Ø 22 mm/ 0.87 in. hole	12	K1E005NLH	
5 step 12	K1E005NCH	0.180/0.397				
"Multi-fixing"			12			
By Ø 22 mm/ 0.87 in. hole	12					

Cam switches

Complete switches, 12 and 20 A

Front mounting, "multi-fixing" or by Ø 22 mm hole

With 45 x 45 mm front plate, 35 mm handle and metallic legend with black marking







Stepping switches (2 to 5 step), 2-pole, with "0" position					
Wiring diagram and switching programme	Marking and switch position	Front mounting method	Thermal current (Ith)	Reference	Weight
			A		kg/lb
 <p>560818 K.....LH</p>		 <p>"Multi-fixing"</p>	<p>3 step + "0"</p> <p>12</p>	<p>K1F013QLH</p>	<p>0.170/0.374</p>
		 <p>By Ø 22 mm/ 0.87 in. hole</p>	<p>12</p>	<p>K1F013QCH</p>	<p>0.190/0.419</p>
 <p>560817 K.....CH</p>		 <p>"Multi-fixing"</p>	<p>4 step + "0"</p> <p>12</p>	<p>K1H014QLH</p>	<p>0.195/0.430</p>
		 <p>By Ø 22 mm/ 0.87 in. hole</p>	<p>12</p>	<p>K1H014QCH</p>	<p>0.215/0.474</p>
		 <p>"Multi-fixing"</p>	<p>5 step + "0"</p> <p>20</p>	<p>K2K015QLH</p>	<p>0.225/0.496</p>
		 <p>By Ø 22 mm/ 0.87 in. hole</p>	<p>12</p>	<p>K1K015QCH</p>	<p>0.245/0.540</p>

Cam switches

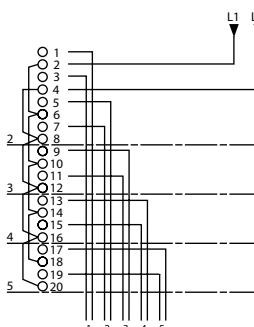
Complete switches, 12 and 20 A

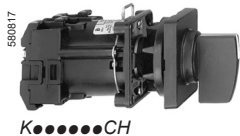
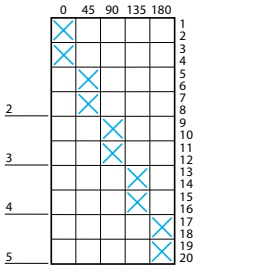
Front mounting, "multi-fixing" or by Ø 22 mm hole

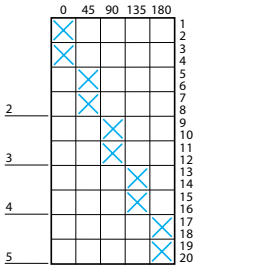
With 45 x 45 mm front plate, 35 mm handle and metallic legend with black marking

Stepping switches (2 to 5 step), 2-pole, without "0" position					
Wiring diagram and switching programme	Marking and switch position	Front mounting method	Thermal current (Ith)	Reference	Weight
			A		
 <p>5900818 K●●●●●LH</p>		 	2 step 12	K1D012NLH	0.140/0.309
			20		
 <p>5900817 K●●●●●CH</p>		 	3 step 12	K1F013NLH	0.170/0.374
			20		
			12	K1F013NCH	0.190/0.419
			12	By Ø 22 mm/ 0.87 in. hole	0.195/0.430
	 	4 step 12	K1H014NLH	0.195/0.430	
		12			K1H014NCH
		12	By Ø 22 mm/ 0.87 in. hole	0.245/0.540	
		20	K2K015NCH	0.245/0.540	



Cam switches

Complete switches, 12 and 20 A

Front mounting, "multi-fixing" or by Ø 22 mm hole

With 45 x 45 mm front plate, 35 mm handle and metallic legend with black marking

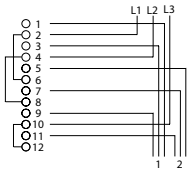
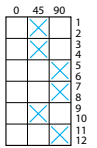
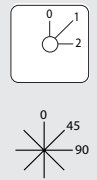
Stepping switches (2 and 3 step), 3-pole, with "0" position

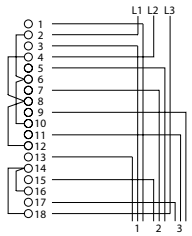
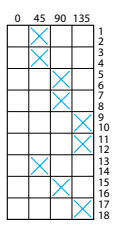
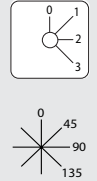





Wiring diagram and switching programme	Marking and switch position	Front mounting method	Thermal current (Ith)	Reference	Weight
 <p>580818 K●●●●●LH</p>	 		"Multi-fixing" 20	K2F022QLH	0.170/0.374
			2 step + "0"	A	kg/lb
 <p>580817 K●●●●●CH</p>	 		"Multi-fixing" 12	K1I023QLH	0.215/0.474
			By Ø 22 mm/ 0.87 in. hole	12	K1I023QCH

Cam switches

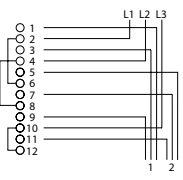
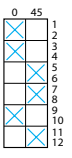
Complete switches, 12 and 20 A

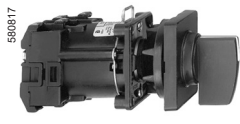
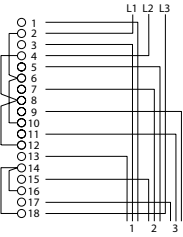
Front mounting, "multi-fixing" or by Ø 22 mm hole

With 45 x 45 mm front plate, 35 mm handle and metallic legend with black marking

Stepping switches (2 and 3 step), 3-pole, without "0" position					
Wiring diagram and switching programme	Marking and switch position	Front mounting method	Thermal current (Ith)	Reference	Weight
			A		kg/lb
 <p>560818 K●●●●●LH</p>	 	 	2 step		
			12	K1F022NLH	0.170/0.374
 <p>560817 K●●●●●CH</p>	 	 	3 step		
			12	K1I023NLH	0.215/0.474
			By Ø 22 mm/ 0.87 in. hole	12	K1I023NCH

Cam switches

Complete switches, 12 and 20 A

Front mounting, "multi-fixing" or by Ø 22 mm hole

With 45 x 45 mm front plate, 35 mm handle and metallic legend with black marking

Reversing switches with spring return from 315° and from 45° to "0" position



Wiring diagram and switching programme	Marking and switch position	Front mounting method	Number of poles	Thermal current (Ith) A	Reference	Weight kg/lb
		"Multi-fixing"	1	12	K1B006TLH	0.115/0.253
		By Ø 22 mm/ 0.87 in. hole	1	12	K1B006TCH	0.135/0.298

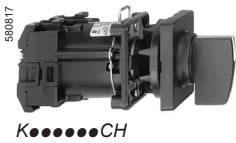

Changeover switches, 1 to 4-pole

Wiring diagram and switching programme	Marking and switch position	Front mounting method	Number of poles	With "0" position		
				Thermal current (Ith) A	Reference	
		"Multi-fixing"	1	12	K1B001ULH	0.115/0.253
				20	K2B001ULH	0.115/0.253
				12	K1D002ULH	0.140/0.309
				20	K2D002ULH	0.140/0.309
				12	K1F003ULH	0.170/0.374
				20	K2F003ULH	0.170/0.374
				12	K1H004ULH	0.195/0.430
				20	K2H004ULH	0.195/0.430
				12	K1B001UCH	0.135/0.298
				20	K2B001UCH	0.135/0.298
				12	K1D002UCH	0.160/0.353
				20	K2D002UCH	0.160/0.353
				12	K1F003UCH	0.190/0.419
				20	K2F003UCH	0.190/0.419
				12	K1H004UCH	0.215/0.474
				20	K2H004UCH	0.215/0.474
		"Multi-fixing"	1	Without "0" position		
				12	K1B011ULH	0.115/0.253
				20	K2B011ULH	0.115/0.253
				12	K1D012ULH	0.140/0.309
				20	K2D012ULH	0.140/0.309
				12	K1F013ULH	0.170/0.374
				12	K1H014ULH	0.195/0.430
				20	K2H014ULH	0.195/0.430
				12	K1B011UCH	0.135/0.298
				12	K1D012UCH	0.160/0.353
				20	K2D012UCH	0.160/0.353
				12	K1F013UCH	0.190/0.419
				20	K2F013UCH	0.190/0.419
				12	K1H014UCH	0.215/0.474

Cam switches

Complete switches, 12 A

Front mounting, "multi-fixing" or by Ø 22 mm hole

With 45 x 45 mm front plate, 35 mm handle and metallic legend with black marking

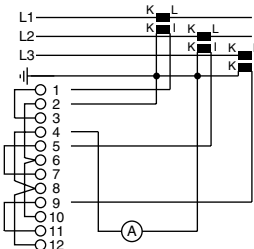
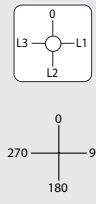
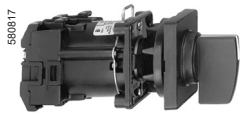
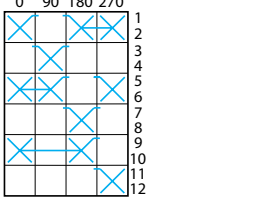
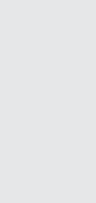
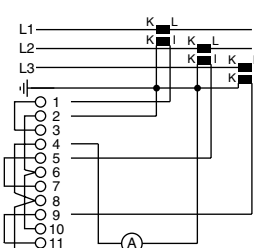
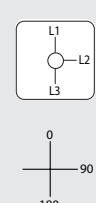
Ammeter switches					
Wiring diagram and switching programme	Marking and switch position	Front mounting method	Thermal current (Ith)	Reference	Weight
For 3 circuits					
 <p>580818 K●●●●●LH</p>			With "0" position		
			"Multi-fixing"	12	K1F003MLH
 <p>580817 K●●●●●CH</p>			With "0" position		
			By Ø 22 mm/ 0.87 in. hole	12	K1F003MCH
		Without "0" position			
		By Ø 22 mm/ 0.87 in. hole	12	K1F013MCH	0.190/0.419

Cam switches

Complete switches, 12 A

Front mounting, "multi-fixing" or by Ø 22 mm hole

With 45 x 45 mm front plate, 35 mm handle and metallic legend with black marking

Ammeter switches (continued)					
Wiring diagram and switching programme	Marking and switch position	Front mounting method	Thermal current (Ith)	Reference	Weight
			A		kg/lb

For 4 circuits

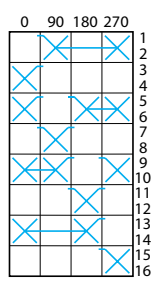
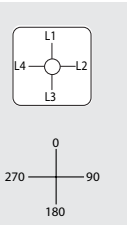
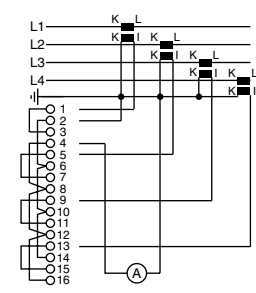







"Multi-fixing"	Without "0" position		
	12	K1H014MLH	0.195/0.430

Cam switches

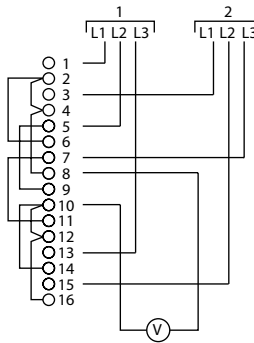
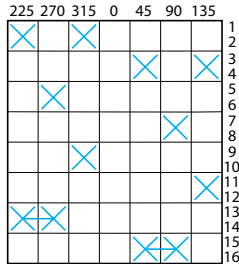
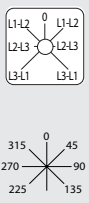
Complete switches, 12 A

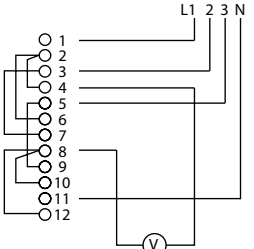
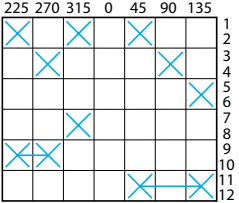
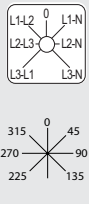
Front mounting, "multi-fixing" or by Ø 22 mm hole

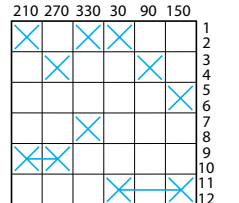
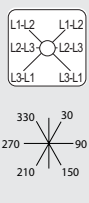
With 45 x 45 mm front plate, 35 mm handle and metallic legend with black marking

Voltmeter switches						
Wiring diagram	Switching programme	Marking and switch position	Front mounting method	Thermal current (Ith)	Reference	Weight
				A		kg/lb
For measurements between 3 phases of 2 supplies						
				With "0" position		
				"Multi-fixing" 12	K1H026MLH	0.205/0.452
For measurements between 3 phases and between each of the 3 phases and neutral						
				With "0" position		
				"Multi-fixing" 12	K1F027MLH	0.170/0.374
				Without "0" position		
				"Multi-fixing" 12	K1F037MLH	0.170/0.374
				By Ø 22 mm/ 0.87 in. hole		
				By Ø 22 mm/ 0.87 in. hole		

5800818



K.....LH

5800817



K.....CH

Cam switches

Complete switches, 12 A

Front mounting, "multi-fixing" or by Ø 22 mm hole

With 45 x 45 mm front plate, 35 mm handle and metallic legend with black marking

Voltmeter switches (continued)

Wiring diagram	Switching programme	Marking and switch position	Front mounting method	Thermal current (Ith)	Reference	Weight
				A		kg/lb

For measurements between 3 phases

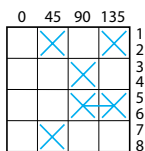
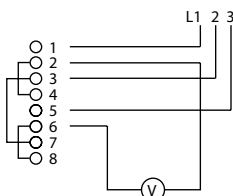

With "0" position
"Multi-fixing" 12 [K1D024MLH](#) 0.140/0.309

By Ø 22 mm / 0.87 in. hole 12 [K1D024MCH](#) 0.160/0.353

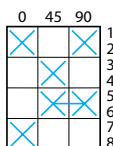
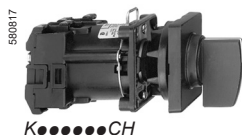

Without "0" position
By Ø 22 mm / 0.87 in. hole 12 [K1D034MCH](#) 0.160/0.353

For measurements between 3 phases and between 1 phase and neutral

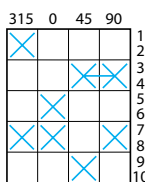
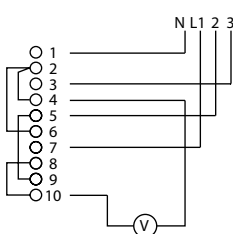

Without "0" position
"Multi-fixing" 12 [K1E035MLH](#) 0.160/0.353

By Ø 22 mm / 0.87 in. hole 12 [K1E035MCH](#) 0.180/0.397

Cam switches

Adaptable sub-assemblies, 12 and 20 A

Bodies (contact blocks + fixing plate)

Switches with 45° switching angle

Wiring diagram and switching programme	Switch position	Mounting method	Reference to be completed (1)	Weight kg/lb
--	-----------------	-----------------	-------------------------------	--------------

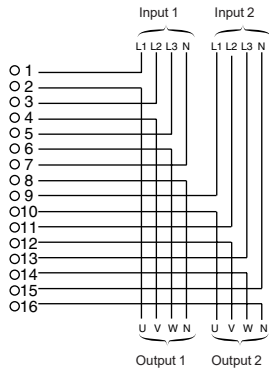
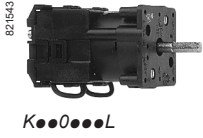

1-pole	Front	By Ø 22 mm/0.87 in. hole	K●A001A	0.075/0.165
---------------	-------	--------------------------	----------------	-------------

2-pole	Front	Multi-fixing By Ø 22 mm/0.87 in. hole	K●B002AL	0.101/0.223
	Rear		K●B002AX (2) K●B502A	0.085/0.187 0.163/0.359 0.125/0.275

3-pole	Front	By Ø 22 mm/0.87 in. hole	K●C003A	0.105/0.231
			K●C003AX (2)	0.183/0.403

4-pole	Front	By Ø 22 mm/0.87 in. hole	K●D004A	0.110/0.242
---------------	-------	--------------------------	----------------	-------------

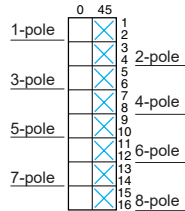

5-pole	Front	By Ø 22 mm/0.87 in. hole	K●E005A	0.130/0.287
---------------	-------	--------------------------	----------------	-------------

6-pole	Front	By Ø 22 mm/0.87 in. hole	K●F006A	0.140/0.309
---------------	-------	--------------------------	----------------	-------------

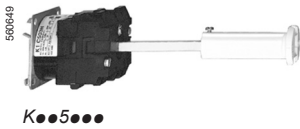

7-pole	Front	By Ø 22 mm/0.87 in. hole	K●G007A	0.160/0.353
---------------	-------	--------------------------	----------------	-------------



(1) To order a cam switch with thermal current $I_{th} = 12$ A, replace the ● in the reference by 1.
Example **K1A001A**.
To order a cam switch with thermal current $I_{th} = 20$ A, replace the ● in the reference by 2.
Example **K2A001A**.

(2) Bodies using the Ø 22 mm/0.87 in. hole mounting method that can be fitted with chromium plated metal bezel operating heads, type **KAXZ1●●●**.

Cam switches

Adaptable sub-assemblies, 12 and 20 A

Bodies (contact blocks + fixing plate)

Switches with 90° switching angle

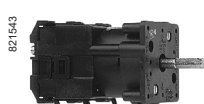

K●●0●●●L

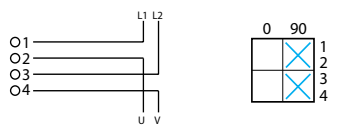

2-pole

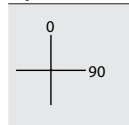

Front	Multi-fixing	K●B1002HL	0.121/0.267
	By Ø 22 mm/0.87 in. hole	K●B1002H	0.105/0.231
		K●B1002HX (2)	0.183/0.403

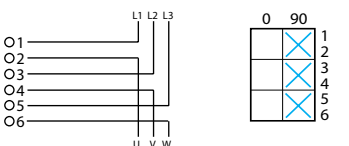

3-pole

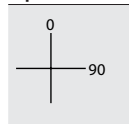

Front	By Ø 22 mm/0.87 in. hole	K●C003H	0.105/0.231
Rear		K●C503H	0.140/0.309



K●●0●●●

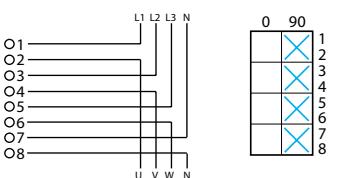

4-pole

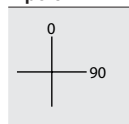

Front	By Ø 22 mm/0.87 in. hole	K●D004H	0.110/0.242
-------	--------------------------	---------	-------------

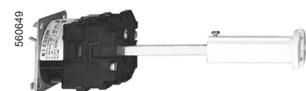

K●●5●●●

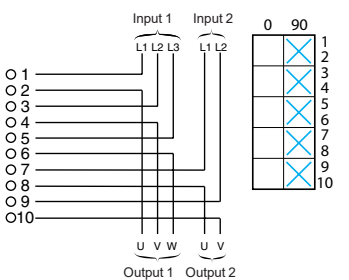

5-pole

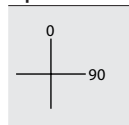

Front	By Ø 22 mm/0.87 in. hole	K●E005H	0.130/0.287
-------	--------------------------	---------	-------------

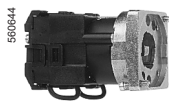

K●●0●●●X

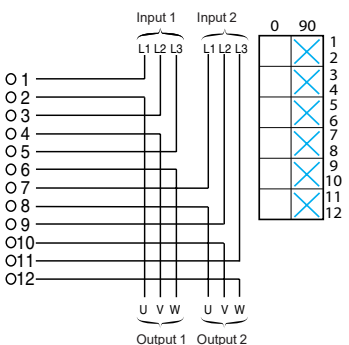

6-pole

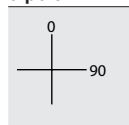

Front	Multi-fixing	K●F006HL	0.156/0.344
-------	--------------	----------	-------------

(1) To order a cam switch with thermal current $I_{th} = 12 A$, replace the ● in the reference by 1.

Example **K1C003H**.

To order a cam switch with thermal current $I_{th} = 20 A$, replace the ● in the reference by 2.

Example **K2C003H**.

(2) Bodies using the Ø 22 mm/0.87 in. hole mounting method that can be fitted with chromium plated metal bezel operating heads, type **KAXZ1●●●**.

Cam switches

Adaptable sub-assemblies, 12 and 20 A

Bodies (contact blocks + fixing plate)



OFF-ON switches with 45° switching angle

Wiring diagram	Switching programme	Switch position	Mounting method	Reference to be completed (1)	Weight kg/lb
			Front By \varnothing 22 mm/0.87 in. hole	K●A001A	0.075/0.165

OFF-ON switches with spring return from 30° to “0” position

Wiring diagram	Switching programme	Switch position	Mounting method	Reference to be completed (1)	Weight kg/lb
			Front By \varnothing 22 mm/0.87 in. hole	K●A001T	0.075/0.165

(1) To order a cam switch with thermal current $I_{th} = 12$ A, replace the ● in the reference by 1.
 Example **K1A001A**.
 To order a cam switch with thermal current $I_{th} = 20$ A, replace the ● in the reference by 2.
 Example **K2A001A**.

Cam switches

Adaptable sub-assemblies, 12 and 20 A

Bodies (contact blocks + fixing plate)



K●●0●●●

OFF-ON switches with spring return from 30° and from 330° to "0" position

Wiring diagram and switching programme	Switch position	Mounting method	Reference to be completed (1)	Weight kg/lb
 		Front By Ø 22 mm/0.87 in. hole	K●B004T	0.085/0.187

OFF-ON switches with momentary-contact function

Wiring diagram and switching programme	Switch position	Mounting method	Reference to be completed (1)	Weight kg/lb
 		Front By Ø 22 mm/0.87 in. hole	K●B001D	0.085/0.187

OFF-ON changeover switches with spring return from 240° to 270° and from 120° to 90°

Wiring diagram and switching programme	Switch position	Mounting method	Reference to be completed (1)	Weight kg/lb
 		Front By Ø 22 mm/0.87 in. hole	K●D005T	0.110/0.242

(1) To order a cam switch with thermal current $I_{th} = 12 A$, replace the ● in the reference by 1.
 Example **K1B004T**.
 To order a cam switch with thermal current $I_{th} = 20 A$, replace the ● in the reference by 2.
 Example **K2B004T**.

Cam switches

Adaptable sub-assemblies, 12 and 20 A

Bodies (contact blocks + fixing plate)

Changeover switches with "0" position

Wiring diagram and switching programme	Switch position	Mounting method	Reference to be completed (1)	Weight kg/lb
--	-----------------	-----------------	-------------------------------	--------------

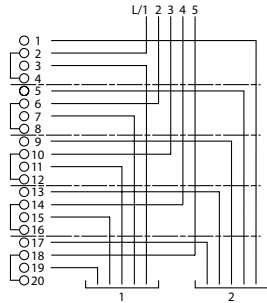
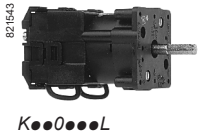

1-pole		Mounting method	Reference to be completed (1)	Weight kg/lb
Front	Multi-fixing			
Rear				

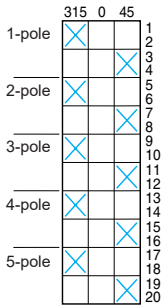
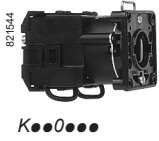

2-pole		Mounting method	Reference to be completed (1)	Weight kg/lb
Front	Multi-fixing			
Rear		K●D002UX (2)	0.188/0.414	

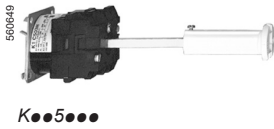

3-pole		Mounting method	Reference to be completed (1)	Weight kg/lb
Front	Multi-fixing			
Rear		K●F503U	0.218/0.481	



4-pole		Mounting method	Reference to be completed (1)	Weight kg/lb
Front	By Ø 22 mm/0.87 in. hole			

5-pole		Mounting method	Reference to be completed (1)	Weight kg/lb
Front	By Ø 22 mm/0.87 in. hole			

(1) To order a cam switch with thermal current I_{th} = 12 A, replace the ● in the reference by 1.
 Example **K1B001U**.
 To order a cam switch with thermal current I_{th} = 20 A, replace the ● in the reference by 2.
 Example **K2B001U**.
 (2) Bodies using the Ø 22 mm/0.87 in. hole mounting method that can be fitted with chromium plated metal bezel operating heads, type **KAXZ1●●●**.

Cam switches

Adaptable sub-assemblies, 12 and 20 A

Bodies (contact blocks + fixing plate)

Changeover switches without "0" position

Wiring diagram and switching programme	Switch position	Mounting method	Reference to be completed (1)	Weight kg/lb
	1-pole	Front By Ø 22 mm/0.87 in. hole	K●B011U	0.085/0.187
	2-pole	Front By Ø 22 mm/0.87 in. hole	K●D012U	0.110/0.242
	3-pole	Front Multi-fixing By Ø 22 mm/0.87 in. hole	K●F013U K●F013UX (2)	0.140/0.309 0.218/0.481
	Rear	K●F513U	0.175/0.386	
	4-pole	Multi-fixing By Ø 22 mm/0.87 in. hole	K●H014U K●H014UX (2)	0.165/0.364 0.243/0.536
5-pole	Front Multi-fixing By Ø 22 mm/0.87 in. hole	K●K015UL K●K015U	0.211/0.465 0.195/0.430	

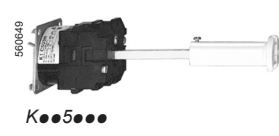
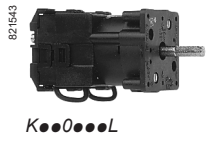

(1) To order a cam switch with thermal current $I_{th} = 12 A$, replace the ● in the reference by 1.
 Example **K1B011U**.
 To order a cam switch with thermal current $I_{th} = 20 A$, replace the ● in the reference by 2.
 Example **K2B011U**.
 (2) Bodies using the Ø 22 mm/0.87 in. hole mounting method that can be fitted with chromium plated metal bezel operating heads, type **KAXZ1●●●**.

Cam switches

Adaptable sub-assemblies, 12 and 20 A

Bodies (contact blocks + fixing plate)

Reversing switches with "0" position

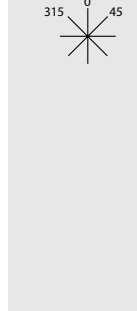
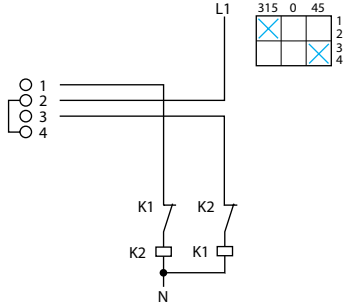
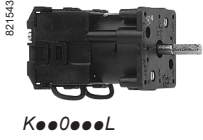

Wiring diagram	Switching programme	Switch position	Mounting method	Reference to be completed (1)	Weight kg/lb	
			Front	Multi-fixing By Ø 22 mm/ 0.87 in. hole	K●B001UL K●B001U	0.101/0.223 0.085/0.187
			Rear		K●B501U	0.125/0.275

Reversing switches with spring return from 315° and from 45° to "0" position

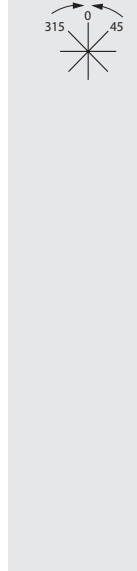
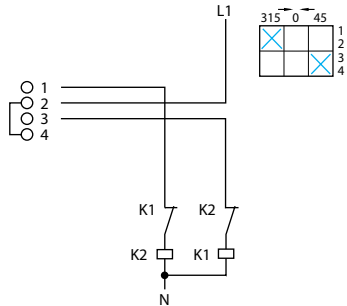

Wiring diagram	Switching programme	Switch position	Mounting method	Reference to be completed (1)	Weight kg/lb
			Front	By Ø 22 mm/ 0.87 in. hole	K●B006T 0.085/0.187

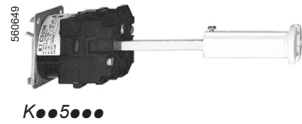

(1) To order a cam switch with thermal current $I_{th} = 12 A$, replace the ● in the reference by 1.
Example **K1B001U**.
To order a cam switch with thermal current $I_{th} = 20 A$, replace the ● in the reference by 2.
Example **K2B001U**.

Cam switches

Adaptable sub-assemblies, 12 A

Bodies (contact blocks + fixing plate)

BCD encoded output switches with "0" position					
Wiring diagram	Switching programme	Switch position	Mounting method	Reference (1)	Weight kg/lb
		2 decimal	Front	By Ø 22 mm/ 0.87 in. hole	K1B002B 0.085/0.187
		3 decimal	Front	Multi-fixing By Ø 22 mm/ 0.87 in. hole	K1B003BL 0.101/0.223 K1B003B 0.085/0.187
		5 decimal	Front	Multi-fixing	K1C005BL 0.121/0.267
		6 decimal	Front	By Ø 22 mm/ 0.87 in. hole	K1C006B 0.105/0.231 K1C006BX (2) 0.183/0.403
		7 decimal	Front	By Ø 22 mm/ 0.87 in. hole	K1C007B 0.105/0.231
		8 decimal	Front	Multi-fixing	K1D008BL 0.126/0.278

(1) Ith = 12 A.

(2) Bodies using the Ø 22 mm/0.87 in. hole mounting method that can be fitted with chromium plated metal bezel operating heads, type **KAXZ1**...

Cam switches

Adaptable sub-assemblies, 12 A

Bodies (contact blocks + fixing plate)

BCD encoded output switches with "0" position (continued)

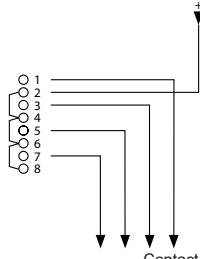
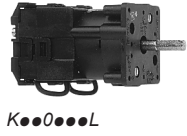

87	65	43	21	Contact marking	Value
8	4	2	1		0
			X		30
			X		60
			X		90
X					120
			X		150
			X		180
			X		210
X					240
			X		270
			X		300
X					330

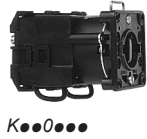

9 decimal	Switch position	Mounting method	Reference (1)	Weight kg/lb
	Front	Multi-fixing	K1D009BL	0.126/0.278
		By Ø 22 mm/0.87 in. hole	K1D009B	0.110/0.242

11 decimal	Switch position	Mounting method	Reference (1)	Weight kg/lb
	Front	By Ø 22 mm/0.87 in. hole	K1D011B	0.110/0.242

BCD encoded output switches without "0" position

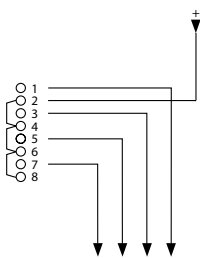
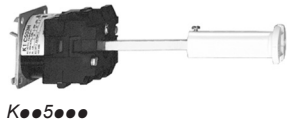

87	65	43	21	Contact marking	Value
8	4	2	1		0
			X		45
			X		90
X					135
			X		180
			X		225



3 decimal	Switch position	Mounting method	Reference (1)	Weight kg/lb
	Front	By Ø 22 mm/0.87 in. hole	K1B023B	0.085/0.187

5 decimal	Switch position	Mounting method	Reference (1)	Weight kg/lb
	Front	By Ø 22 mm/0.87 in. hole	K1C025B	0.105/0.231
			K1C025BX (2)	0.183/0.403

6 decimal	Switch position	Mounting method	Reference (1)	Weight kg/lb
	Front	By Ø 22 mm/0.87 in. hole	K1C026B	0.105/0.231

(1) I_{th} = 12 A.
 (2) Bodies using the Ø 22 mm/0.87 in. hole mounting method that can be fitted with chromium plated metal bezel operating heads, type **KAXZ1000**.

Cam switches

Adaptable sub-assemblies, 12 A

Bodies (contact blocks + fixing plate)

BCD encoded output switches without "0" position (continued)

Wiring diagram and switching programme	Switch position	Mounting method	Reference (1)	Weight kg/lb
--	-----------------	-----------------	---------------	--------------

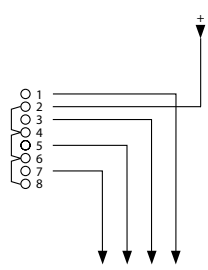

7 decimal				
	Front	By Ø 22 mm/0.87 in. hole	K1D027B	0.105/0.231
			K1D027BX (2)	0.183/0.403

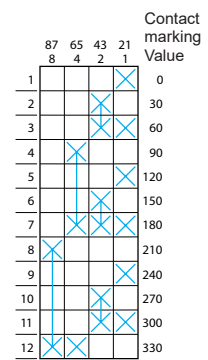
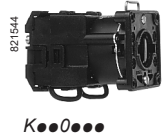

8 decimal				
	Front	Multi-fixing By Ø 22 mm/0.87 in. hole	K1D028BL	0.126/0.278
			K1D028BX (2)	0.188/0.414



10 decimal				
	Front	Multi-fixing By Ø 22 mm/0.87 in. hole	K1D030BL	0.126/0.278
			K1D030B	0.110/0.242

11 decimal				
	Front	By Ø 22 mm/0.87 in. hole	K1D031B	0.110/0.242

12 decimal				
	Front	By Ø 22 mm/0.87 in. hole	K1D032B	0.110/0.242

(1) Ith = 12 A.

(2) Bodies using the Ø 22 mm/0.87 in. hole mounting method that can be fitted with chromium plated metal bezel operating heads, type **KAXZ1●●●**.

Cam switches

Adaptable sub-assemblies, 12 and 20 A

Bodies (contact blocks + fixing plate)

Paralleling switches with "0" position					
Wiring diagram	Switching programme	Switch position	Mounting method	Reference to be completed (1)	Weight kg/lb
1-pole for 2 loads					
			Front	Multi-fixing	K●B002GL 0.101/0.223
1-pole for 3 loads					
			Front	Multi-fixing	K●C003G 0.105/0.231 By Ø 22 mm/ 0.87 in. hole K●C003GX (2) 0.183/0.403
2-pole for 2 loads					
			Front	Multi-fixing	K●D012G 0.110/0.242 By Ø 22 mm/ 0.87 in. hole

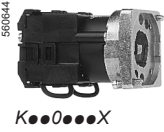
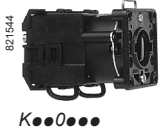
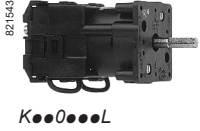

(1) To order a cam switch with thermal current $I_{th} = 12 A$, replace the ● in the reference by 1.

Example **K1B002G**.

To order a cam switch with thermal current $I_{th} = 20 A$, replace the ● in the reference by 2.

Example **K2B002G**.







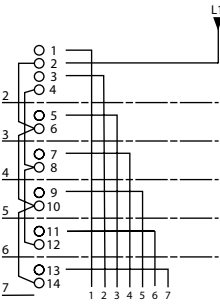

(2) Bodies using the Ø 22 mm/0.87 in. hole mounting method that can be fitted with chromium plated metal bezel operating heads, type **KAXZ1●●●**.

Cam switches

Adaptable sub-assemblies, 12 and 20 A

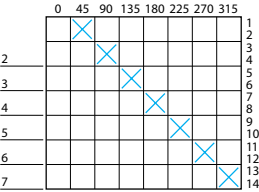
Bodies (contact blocks + fixing plate)

Stepping switches (2 to 11 step), single-pole, with "0" position

Wiring diagram and switching programme	Switch position	Mounting method	Reference to be completed (1)	Weight kg/lb
 <p>821543 K●0●●●L</p> 	3 step + "0" 	Front By Ø 22 mm/0.87 in. hole	K●C003Q K●C003QX (2)	0.105/0.231 0.183/0.403
	4 step + "0" 	Front By Ø 22 mm/0.87 in. hole	K●D004Q	0.110/0.242
 <p>821544 K●0●●●●</p> 	5 step + "0" 	Front By Ø 22 mm/0.87 in. hole	K●E005QX (2)	0.208/0.458
	6 step + "0" 	Front Multi-fixing By Ø 22 mm/0.87 in. hole	K●F006QL K●F006Q	0.156/0.344 0.140/0.309
 <p>820844 K●0●●●X</p>	7 step + "0" 	Front Multi-fixing	K●G007QL	0.176/0.388

(1) To order a cam switch with thermal current I_{th} = 12 A, replace the ● in the reference by 1.

Example **K1B002Q**.

To order a cam switch with thermal current I_{th} = 20 A, replace the ● in the reference by 2.

Example **K2B002Q**.

(2) Bodies using the Ø 22 mm/0.87 in. hole mounting method that can be fitted with chromium plated metal bezel operating heads, type **KAXZ1●●●**.

Cam switches

Adaptable sub-assemblies, 12 and 20 A

Bodies (contact blocks + fixing plate)

Stepping switches (2 to 11 step), single-pole, with "0" position (continued)

Wiring diagram and switching programme	Switch position	Mounting method	Reference to be completed (1)	Weight kg/lb
--	-----------------	-----------------	-------------------------------	--------------

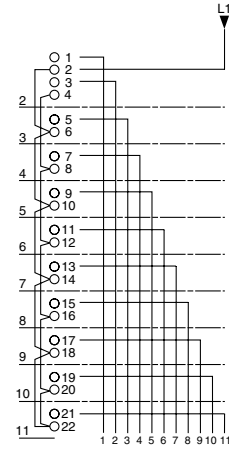
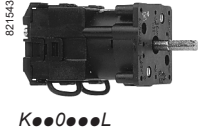

8 step + "0"				
	Front	Multi-fixing	K●H008QL	0.181/0.399



9 step + "0"				
	Front	By Ø 22 mm/ 0.87 in. hole	K●I009Q	0.185/0.408

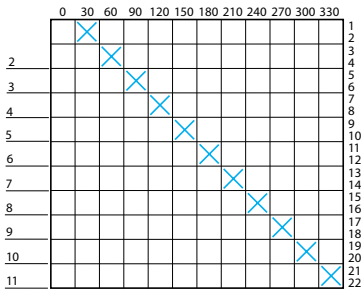

10 step + "0"				
	Front	Multi-fixing	K●K010QL	0.211/0.465
		By Ø 22 mm/ 0.87 in. hole	K●K010Q	0.195/0.430
			K●K010QX (2)	0.273/0.602

11 step + "0"				
	Front	Multi-fixing	K●L011QL	0.231/0.509

(1) To order a cam switch with thermal current $I_{th} = 12 A$, replace the ● in the reference by 1.
 Example **K1H008Q**.
 To order a cam switch with thermal current $I_{th} = 20 A$, replace the ● in the reference by 2.
 Example **K2H008Q**.
 (2) Bodies using the Ø 22 mm/0.87 in. hole mounting method that can be fitted with chromium plated metal bezel operating heads, type **KAXZ1●●●**.

Cam switches

Adaptable sub-assemblies, 12 and 20 A

Bodies (contact blocks + fixing plate)

Stepping switches (2 to 12 step), single-pole, without "0" position

Wiring diagram and switching programme	Switch position	Mounting method	Reference to be completed (1)	Weight kg/lb
<p>821543 K●●0●●●L</p>		2 step		
		Front	By Ø 22 mm/0.87 in. hole	K●B002NX (2)
<p>821544 K●●0●●●</p>		3 step		
		Front	Multi-fixing By Ø 22 mm/0.87 in. hole	K●C003NL K●C003N K●C003NX (2)
<p>56064 K●●0●●●</p>		4 step		
		Front	Multi-fixing By Ø 22 mm/0.87 in. hole	K●D004NL K●D004N
<p>56064 K●●0●●●X</p>		5 step		
		Front	Multi-fixing By Ø 22 mm/0.87 in. hole	K●E005N K●E005NX (2)
<p>56064 K●●0●●●X</p>		6 step		
		Front	Multi-fixing By Ø 22 mm/0.87 in. hole	K●F006N K●F006NX (2)
<p>56064 K●●0●●●X</p>		7 step		
		Front	Multi-fixing By Ø 22 mm/0.87 in. hole	K●G007NL K●G007N K●G007NX (2)
<p>56064 K●●0●●●X</p>		8 step		
		Front	Multi-fixing By Ø 22 mm/0.87 in. hole	K●H008NL K●H008N

(1) To order a cam switch with thermal current $I_{th} = 12 A$, replace the ● in the reference by 1.
 Example **K1B002N**.
 To order a cam switch with thermal current $I_{th} = 20 A$, replace the ● in the reference by 2.
 Example **K2B002N**.
 (2) Bodies using the Ø 22 mm/0.87 in. hole mounting method that can be fitted with chromium plated metal bezel operating heads, type **KAXZ1●●●**.

Cam switches

Adaptable sub-assemblies, 12 and 20 A

Bodies (contact blocks + fixing plate)

Stepping switches (2 to 12 step), single-pole, without "0" position (continued)

Wiring diagram and switching programme	Switch position	Mounting method	Reference to be completed (1)	Weight kg
--	-----------------	-----------------	-------------------------------	-----------

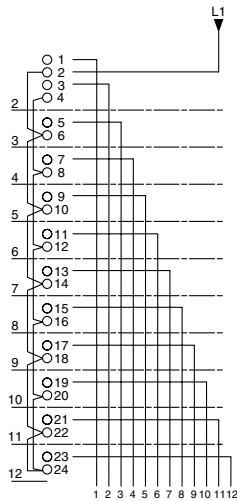
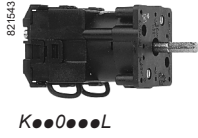

10 step		Front	Multi-fixing	K●K010NL	0.211/0.465
	By \varnothing 22 mm/ 0.87 in. hole			K●K010N	0.195/0.430
				K●K010NX (2)	0.273/0.602

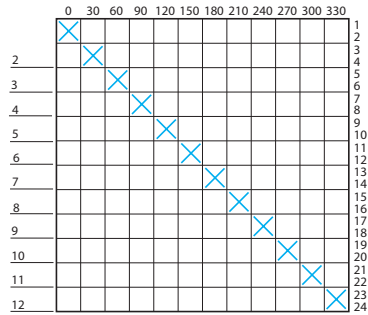
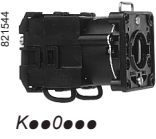

12 step		Front	Multi-fixing	K●M021NL	0.241/0.531



(1) To order a cam switch with thermal current $I_{th} = 12$ A, replace the ● in the reference by 1.
Example **K11009N**.
To order a cam switch with thermal current $I_{th} = 20$ A, replace the ● in the reference by 2.
Example **K21009N**.

(2) Bodies using the \varnothing 22 mm/0.87 in. hole mounting method that can be fitted with chromium plated metal bezel operating heads, type **KAXZ1●●●**.

Cam switches

Adaptable sub-assemblies, 12 and 20 A

Bodies (contact blocks + fixing plate)

Stepping switches (2 to 6 step), 2-pole, with "0" position

Wiring diagram and switching programme	Switch position	Mounting method	Reference to be completed (1)	Weight kg/lb
--	-----------------	-----------------	-------------------------------	--------------

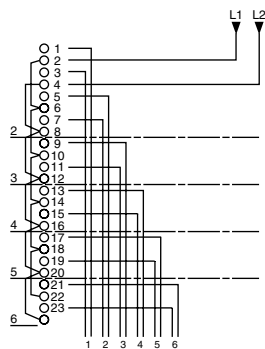
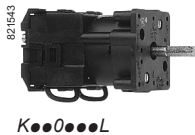

3 step + "0"



Front.	By Ø 22 mm/0.87 in. hole	K●F013Q	0.140/0.309
		K●F013QX (2)	0.218/0.481

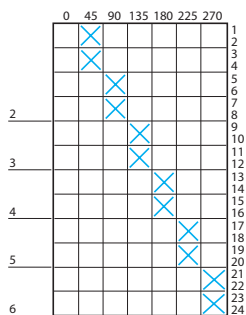

4 step + "0"



Front	By Ø 22 mm/0.87 in. hole	K●H014Q	0.165/0.364
-------	--------------------------	---------	-------------



6 step + "0"

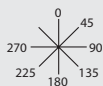

Front	Multi-fixing	K●M016QL	0.241/0.531
	By Ø 22 mm/0.87 in. hole	K●M016Q	0.225/0.496

(1) To order a cam switch with thermal current $I_{th} = 12 A$, replace the ● in the reference by 1.
Example **K1D012Q**.

To order a cam switch with thermal current $I_{th} = 20 A$, replace the ● in the reference by 2.
Example **K2D012Q**.

(2) Bodies using the Ø 22 mm/0.87 in. hole mounting method that can be fitted with chromium plated metal bezel operating heads, type **KAXZ1●●●**.

Cam switches

Adaptable sub-assemblies, 12 and 20 A

Bodies (contact blocks + fixing plate)

Stepping switches (2 to 6 step), 2-pole, without "0" position

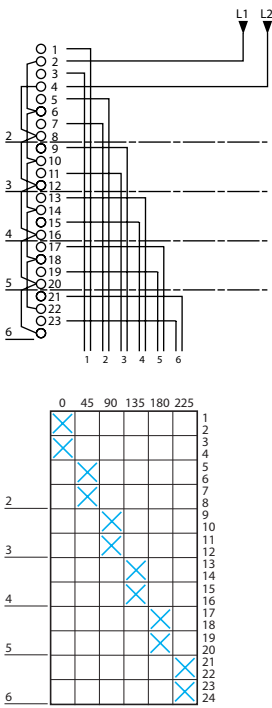
Wiring diagram and switching programme	Switch position	Mounting method	Reference to be completed (1)	Weight kg/lb
	3 step	Front	By Ø 22 mm/0.87 in. hole K●F013N	0.140/0.309
	4 step	Front	Multi-fixing K●H014N	0.165/0.364
		By Ø 22 mm/0.87 in. hole K●H014NX (2)	0.243/0.536	
5 step	Front	By Ø 22 mm/0.87 in. hole K●K015N	0.195/0.430	
6 step	Front	Multi-fixing K●M016NL	0.241/0.531	
	By Ø 22 mm/0.87 in. hole K●M016N	0.225/0.496		

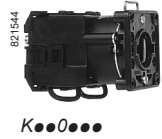
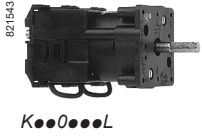

(1) To order a cam switch with thermal current $I_{th} = 12 A$, replace the ● in the reference by 1.
Example **K1D012N**.

To order a cam switch with thermal current $I_{th} = 20 A$, replace the ● in the reference by 2.
Example **K2D012N**.

(2) Bodies using the Ø 22 mm/0.87 in. hole mounting method that can be fitted with chromium plated metal bezel operating heads, type **KAXZ1●●●**.

Cam switches

Adaptable sub-assemblies, 12 and 20 A

Bodies (contact blocks + fixing plate)

Stepping switches (2 to 6 step), 3-pole, with "0" position

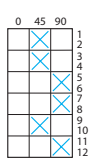
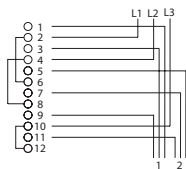
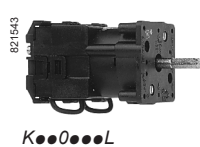

2 step + "0"



Front By \varnothing 22 mm/ 0.87 in. hole **K●F022Q** 0.140/0.309

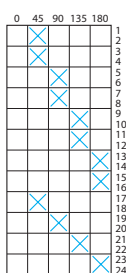
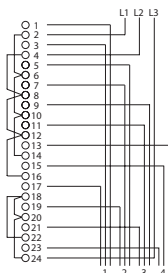

4 step + "0"



Front Multi-fixing **K●M024QL** 0.241/0.531

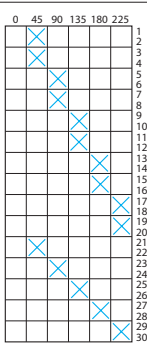
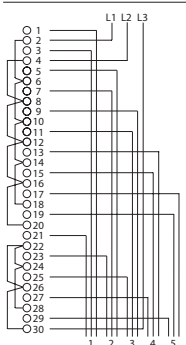

5 step + "0"



Front Multi-fixing **K●P025QL** 0.286/0.630
By \varnothing 22 mm/ **K●P025Q** 0.270/0.595
0.87 in. hole

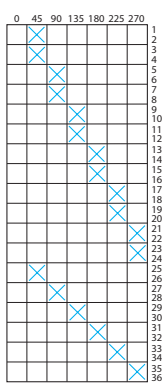
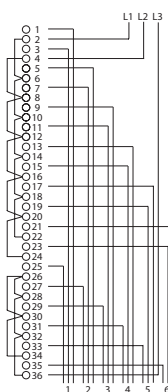

6 step + "0"



Front By \varnothing 22 mm/ **K●S026Q** 0.305/0.672
0.87 in. hole

(1) To order a cam switch with thermal current $I_{th} = 12$ A, replace the ● in the reference by 1.

Example **K1F022Q**.

To order a cam switch with thermal current $I_{th} = 20$ A, replace the ● in the reference by 2.

Example **K2F022Q**.

(2) Bodies using the \varnothing 22 mm/0.87 in. hole mounting method that can be fitted with chromium plated metal bezel operating heads, type **KAXZ1●●●**.

Cam switches

Adaptable sub-assemblies, 12 and 20 A

Bodies (contact blocks + fixing plate)

Stepping switches (2 to 6 step), 3-pole, without "0" position

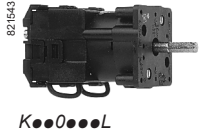

Wiring diagram	Switching programme	Switch position	Mounting method	Reference to be completed (1)	Weight kg/lb
			Front By \varnothing 22 mm/ 0.87 in. hole	K●F022N	0.140/0.309

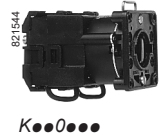

			Front By \varnothing 22 mm/ 0.87 in. hole	K●023N	0.185/0.408
--	--	--	--	---------------	-------------

			Front By \varnothing 22 mm/ 0.87 in. hole	K●M024N K●M024NX (2)	0.225/0.496 0.303/0.668
--	--	--	--	---------------------------------------	----------------------------

			Front By \varnothing 22 mm/ 0.87 in. hole	K●P025N	0.270/0.596
--	--	--	--	----------------	-------------

- (1) To order a cam switch with thermal current $I_{th} = 12$ A, replace the ● in the reference by 1.
 Example **K1F022N**.
 To order a cam switch with thermal current $I_{th} = 20$ A, replace the ● in the reference by 2.
 Example **K2F022N**.
- (2) Bodies using the \varnothing 22 mm/0.87 in. hole mounting method that can be fitted with chromium plated metal bezel operating heads, type **KAXZ1●●●**.

Cam switches

Adaptable sub-assemblies, 12 and 20 A

Bodies (contact blocks + fixing plate)

Stepping switches (2 to 5 step), 4-pole, with "0" position

Wiring diagram	Switching programme	Switch position	Mounting method	Reference to be completed (1)	Weight kg/lb
----------------	---------------------	-----------------	-----------------	-------------------------------	--------------

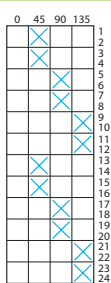
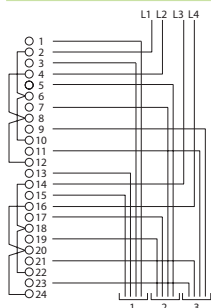
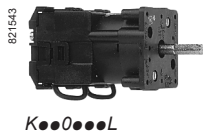

3 step + "0"



Front Multi-fixing **K●M033QL** 0.241/0.531

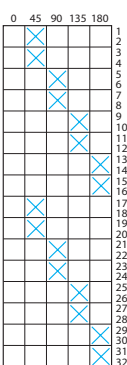
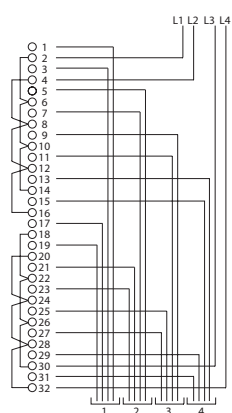

4 step + "0"



Front By Ø 22 mm/ **K●Q034Q** 0.280/0.617
0.87 in. hole

(1) To order a cam switch with thermal current $I_{th} = 12$ A, replace the ● in the reference by 1.
Example **K1H032Q**.
To order a cam switch with thermal current $I_{th} = 20$ A, replace the ● in the reference by 2.
Example **K2H032Q**.

Cam switches

Adaptable sub-assemblies, 12 and 20 A

Bodies (contact blocks + fixing plate)

Stepping switches (2 to 5 step), 4-pole, without "0" position



Wiring diagram	Switching programme	Switch position	Mounting method	Reference to be completed (1)	Weight kg/lb
		3 step 	Front	By Ø 22 mm/ 0.87 in. hole	K●M033N 0.225/0.496
		4 step 	Front	By Ø 22 mm/ 0.87 in. hole	K●Q034N 0.280/0.617

(1) To order a cam switch with thermal current $I_{th} = 12$ A, replace the ● in the reference by 1.
 Example **K1H032N**.
 To order a cam switch with thermal current $I_{th} = 20$ A, replace the ● in the reference by 2.
 Example **K2H032N**.

Cam switches

Adaptable sub-assemblies, 12 and 20 A

Bodies (contact blocks + fixing plate)

Ammeter switches with "0" position

Wiring diagram	Switching programme	Switch position	Mounting method	Reference (1)	Weight kg/lb
----------------	---------------------	-----------------	-----------------	---------------	--------------

For 3 circuits

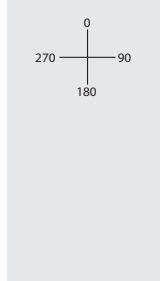
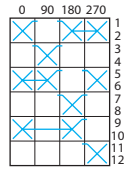
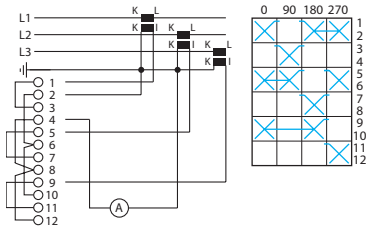
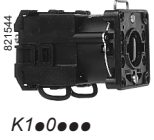

Front By \varnothing 22 mm / **K1F003M**
0.87 in. hole

0.140/0.309

(1) $I_{th} = 12 A$.

Cam switches

Adaptable sub-assemblies, 12 and 20 A

Bodies (contact blocks + fixing plate)

Voltmeter switches

Wiring diagram	Switching programme	Switch position	Mounting method	Reference (1)	Weight kg/lb
----------------	---------------------	-----------------	-----------------	---------------	--------------

For measurements between 3 phases

With "0" position

Front By Ø 22 mm/ 0.87 in. hole **K1D024M** 0.110/0.242

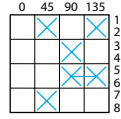
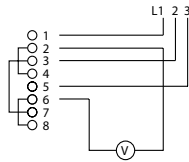

(1) $I_{th} = 12 A$.

Cam switches

Adaptable sub-assemblies, 12 and 20 A

Bodies (contact blocks + fixing plate)

Voltmeter switches (continued)

Wiring diagram	Switching programme	Switch position	Mounting method	Reference (1)	Weight kg/lb
For measurements between 3 phases and between each of the 3 phases and neutral					

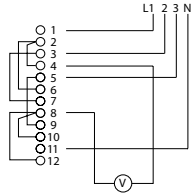

With "0" position

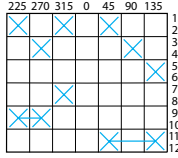

Front By Ø 22 mm/ **K1F027M** 0.140/0.309
0.87 in. hole

(1) I_{th} = 12 A.

Cam switches

Adaptable sub-assemblies, 12 and 20 A

Bodies (contact blocks + fixing plate)

Stepping switches (2 and 3 step), with "0" position + left-hand position

Wiring diagram	Switching programme	Switch position	Mounting method	Reference to be completed (1)	Weight kg/lb
			Front Multi-fixing	K●C002L	0.105/0.231
			Front Multi-fixing	K●D003L	0.110/0.242
			Front Multi-fixing	K●F012LL	0.156/0.344
			Front Multi-fixing	K●H013L	0.165/0.364
			Front Multi-fixing	K●M023L	0.225/0.496

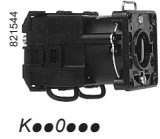
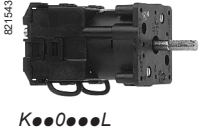





(1) To order a cam switch with thermal current $I_{th} = 12 A$, replace the ● in the reference by 1.
 Example **K1C022Q**.
 To order a cam switch with thermal current $I_{th} = 20 A$, replace the ● in the reference by 2.
 Example **K2C022Q**.

Cam switches

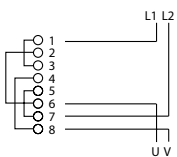
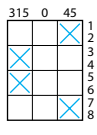
Adaptable sub-assemblies, 12 and 20 A

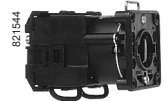
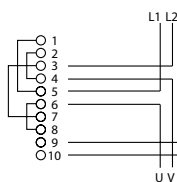
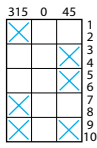
Bodies (contact blocks + fixing plate)

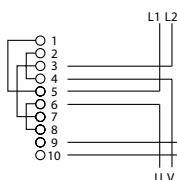
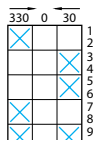
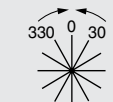
Reversing switches with "0" position							
Wiring diagram	Switching programme	Switch position	Mounting method	Reference to be completed (1)	Weight kg/lb		
2-pole							
 <p>821543 K●●0●●●L</p>				Front	Multi-fixing	K●D002WL	0.126/0.278
					By Ø 22 mm/ 0.87 in. hole	K●D002W	0.110/0.242
3-pole							
 <p>821544 K●●0●●●</p>				Front	Multi-fixing	K●E003WL	0.146/0.322
					By Ø 22 mm/ 0.87 in. hole	K●E003W	0.130/0.287
						K●E003WX (2)	0.208/0.458
Reversing switches with spring return from 330° and from 30° to "0" position							
Wiring diagram	Switching programme	Switch position	Mounting method	Reference to be completed (1)	Weight kg/lb		
3-pole							
 <p>560644 K●●0●●●X</p>				Front	Multi-fixing	K●E023WL	0.146/0.322
					By Ø 22 mm/ 0.87 in. hole	K●E023W	0.130/0.287

(1) To order a cam switch with thermal current $I_{th} = 12$ A, replace the ● in the reference by 1.

Example K1D002W.

To order a cam switch with thermal current $I_{th} = 20$ A, replace the ● in the reference by 2.

Example K2D002W.

(2) Bodies using the Ø 22 mm/0.87 in. hole mounting method that can be fitted with chromium plated metal bezel operating heads, type KAXZ1●●●.

Cam switches

Adaptable sub-assemblies, 12 A

Bodies (contact blocks + fixing plate)



Star-delta switches

Wiring diagram	Switching programme	Switch position	Mounting method	Reference (1)	Weight kg/lb
			Front By \varnothing 22 mm/ 0.87 in. hole	K2H001Y	0.165/0.364

With slave contact, without supply disconnection

			Front By \varnothing 22 mm/ 0.87 in. hole	K2G003Y	0.160/0.353
--	--	--	--	----------------	-------------

Reversing star-delta switches

Wiring diagram	Switching programme	Switch position	Mounting method	Reference (1)	Weight kg/lb
Without slave contact					
			Front By \varnothing 22 mm/ 0.87 in. hole	K2K006Y	0.195/0.430

(1) I_{th} = 20 A.

Cam switches

Adaptable sub-assemblies, 12 and 20 A

Bodies (contact blocks + fixing plate)



K●●0●●●

Pole change switches for 2-speed motors

Wiring diagram	Switching programme	Switch position	Mounting method	Reference to be completed (1)	Weight kg/lb
----------------	---------------------	-----------------	-----------------	-------------------------------	--------------

For motors with 2 separate windings

			Front	By \varnothing 22 mm/ 0.87 in. hole	K●F001P	0.140/0.309
--	--	--	-------	--	----------------	-------------

For motors with 2 separate windings, with centre "0" position

			Front	By \varnothing 22 mm/ 0.87 in. hole	K●F002P	0.140/0.309
--	--	--	-------	--	----------------	-------------

For motors with tapped "Dahlander" windings

			Front	By \varnothing 22 mm/ 0.87 in. hole	K●H004P	0.165/0.364
--	--	--	-------	--	----------------	-------------

(1) To order a cam switch with thermal current $I_{th} = 12$ A, replace the ● in the reference by 1.

Example **K1F001P**.

To order a cam switch with thermal current $I_{th} = 20$ A, replace the ● in the reference by 2.

Example **K2F001P**.

Cam switches

Adaptable sub-assemblies, 12 and 20 A

Bodies (contact blocks + fixing plate)

Pole change switches for 2-speed motors (continued)

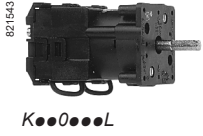

Wiring diagram	Switching programme	Switch position	Mounting method	Reference to be completed (1)	Weight kg/lb	
For motors with tapped "Dahlander" windings, with centre "0" position						
			Front	Multi-fixing	K●H005PL	0.181/0.399
				By Ø 22 mm/ 0.87 in. hole	K●H005P	0.165/0.364



Wiring diagram	Switching programme	Switch position	Mounting method	Reference to be completed (1)	Weight kg/lb	
Reversing pole change switches for 2-speed motors						
For motors with 2 separate windings, with centre "0" position						
			Front	By Ø 22 mm/ 0.87 in. hole	K●K008P	0.195/0.430

For motors with tapped "Dahlander" windings, with centre "0" position						
			Front	Multi-fixing	K●M009PL	0.241/0.531
				By Ø 22 mm/ 0.87 in. hole	K●M009P	0.225/0.496

(1) To order a cam switch with thermal current $I_{th} = 12$ A, replace the ● in the reference by 1.
 Example **K1H005P**.
 To order a cam switch with thermal current $I_{th} = 20$ A, replace the ● in the reference by 2.
 Example **K2H005P**.

Cam switches

Adaptable sub-assemblies, 12 and 20 A
Operating heads

KAG3H



KCG3Y

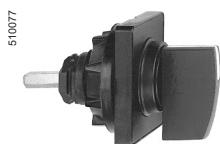

KAC1H



KCC1Y



KBC1S



KBD1H

Heads for "multi-fixing" front mounting bodies

Description	Switching angle and marking	Type of operator	Background colour of legend	Padlocking device	Reference	Weight kg/lb
With 45 x 45 mm/1.77 x 1.77 in. front plate and handle						
With blank legend (for engraving by user)	–	Black handle L = 35 mm/1.38 in.	Matt black Metallic	Without	KAG3H KBG3H	0.012/0.026 0.012/0.026
With marked legend	90°	Red handle L = 35 mm/1.38 in.	Yellow	Without With	KCG3H KCG3Y	0.012/0.026 0.024/0.053
Without legend (1)	–	Black handle L = 35 mm/1.38 in. Red handle L = 35 mm/1.38 in.	–	Without With	KDG3H KDG3Y	0.010/0.022 0.022/0.048

Heads for Ø 22 mm/0.87 in. hole, front mounting bodies

Description	Switching angle and marking	Type of operator	Background colour of legend	Padlocking device	Reference	Weight kg/lb
With 45 x 45 mm/1.77 x 1.77 in. front plate and handle						
With blank legend (for engraving by user)	–	Black handle L = 35 mm/1.38 in.	Matt black Metallic	Without	KAC1H KBC1H	0.048/0.106 0.048/0.106
With marked legend	45°	Black handle L = 35 mm/1.38 in.	Matt black	Without	KAC1H41	0.012/0.026
	45°	Black handle L = 35 mm/1.38 in.	Matt black Metallic	Without	KAC1H48 KBC1H48	0.012/0.026 0.012/0.026
	60°	Black handle L = 35 mm/1.38 in.	Metallic	Without	KBC1H61	0.048/0.106
	90°	Red handle L = 35 mm/1.38 in.	Yellow	Without With	KCC1LH KCC1Y	0.048/0.106 0.060/0.132
Without legend (1)	–	Black handle L = 35 mm/1.38 in.	–	Without	KDC1H	0.046/0.101
With 45 x 45 mm/1.77 x 1.77 in. front plate and key operator (2)						
With blank legend (for engraving by user)	45° and 90°	Key (2)	Matt black Metallic	Without	KAC1S KBC1S	0.063/0.139 0.063/0.139
	60°	Key (2)	Metallic	Without	KBC1Z	0.063/0.139
Without legend (1)	45° and 90°	Key (2)	–	Without	KDC1S	0.061/0.134
	60°	Key (2)	–	Without	KDC1Z	0.061/0.134

With 60 x 60 mm/2.36 x 2.36 in. front plate and handle

Description	Switching angle and marking	Type of operator	Background colour of legend	Padlocking device	Reference	Weight kg/lb
With blank legend (for engraving by user)	–	Black handle L = 42 mm/1.65 in.	Matt black Metallic	Without	KAD1H KBD1H	0.053/0.117 0.053/0.117
With marked legend	90°	Red handle L = 42 mm/1.65 in.	Yellow	Without	KCD1MH	0.053/0.117
Without legend (1)	–	Black handle L = 42 mm/1.65 in.	–	Without	KDD1H	0.053/0.117

(1) For separate marked legend ordering information, see pages 63 to 66.

(2) Head supplied with 601A key. To order a head with a 455 key, add the suffix **R** to the references listed above. Example: reference for Ø 22 mm/0.87 in. hole, front mounting 45 x 45 mm/1.77 x 1.77 in. operating head with 45° switching angle and matt black legend, becomes **KAC1SR**. For a head with 8R15 key, use the suffix **R1**.

Cam switches

Adaptable sub-assemblies, 12 and 20 A
Operating heads

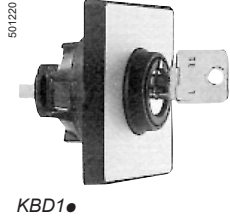

KBD1●



KBA1H



KBA1●



KAXZ1C12

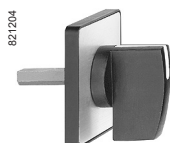

KBE1H

Heads for Ø 22 mm/0.87 in. hole, front mounting bodies (continued)

Description	Switching angle and marking	Type of operator	Background colour of legend	Padlocking device	Reference	Weight kg/lb
With 60 x 60 mm/2.36 x 2.36 in. front plate and key operator (1)						
With blank legend (to be engraved by user)	45° and 90°	Key (1)	Matt black	Without	KAD1S	0.068/0.150
			Metallic	Without	KBD1S	0.068/0.150
	60°	Key (1)	Metallic	Without	KBD1Z	0.068/0.150
Without legend (2)	45° and 90°	Key (1)	–	Without	KDD1S	0.066/0.145

Description	Switching angle and marking	Type of operator	Colour of bezel	Padlocking device	Reference	Weight kg/lb
With Ø 29 mm/1.14 in., metallic finish, plastic bezel and handle or key operator (1)						
Circular heads	–	Black handle L = 35 mm/1.38 in.	Matt black	Without	KAA1H	0.042/0.093
			Metallic	Without	KBA1H	0.042/0.093
	45°	Key (1)	Matt black	Without	KAA1S	0.057/0.126
			Metallic	Without	KBA1S	0.057/0.126
60°	Key (1)	Matt black	Without	KAA1Z	0.057/0.126	

With Ø 38 mm/1.50 in., black, plastic bezel and handle						
Circular head	–	Black handle L = 35 mm/1.38 in.	Matt black	Without	KAA2H	0.048/0.106

With Ø 28.5 mm/1.12 in., chromium plated, metal bezel (3) (2) and standard, handle, long handle or key operator (4)						
Circular heads	–	Standard black handle	Metal	Without	KAXZ1M12	0.040/0.088
		Long black handle	Metal	Without	KAXZ1C12	0.040/0.088
		Long red handle	Metal	Without	KAXZ1C14	0.040/0.088
	30°	Key	Metal	Without	KAXZ1S13● (4)	0.065/0.143
	45°	Key	Metal	Without	KAXZ1S14● (4)	0.065/0.143
60°	Key	Metal	Without	KAXZ1S16● (4)	0.065/0.143	
90°	Key	Metal	Without	KAXZ1S19● (4)	0.065/0.143	

Operating heads for 4 hole, rear mounting bodies

Description	Switching angle and marking	Type of operator	Background colour of legend	Padlocking device	Reference	Weight kg/lb
With 45 x 45 mm/1.77 x 1.77 in. front plate and handle						
With blank legend (to be engraved by user)	–	Black handle L = 35 mm/1.38 in.	Matt black	Without	KAE1H	0.029/0.064
			Metallic	Without	KBE1H	0.029/0.064
With marked legend	90°	Red handle L = 35 mm/1.38 in.	Yellow	Without	KCE1LH	0.029/0.064
Without legend (2)	–	Black handle L = 35 mm/1.38 in.	–	Without	KDE1H	0.027/0.059



With 60 x 60 mm/2.36 x 2.36 in. front plate and handle						
With blank legend (to be engraved by user)	–	Black handle L = 42 mm/1.65 in	Metallic	Without	KBF1H	0.068/0.150
Without legend (2)	–	Black handle L = 42 mm/1.65 in	–	Without	KDF1H	0.066/0.145

(1) Head supplied with 601A key. To order a head with a 455 key, add the suffix **R** to the references listed above. Example: reference for operating head with 60 x 60 mm/2.36 x 2.36 in. front plate, key operator, blank legend, 45° switching angle and matt black background, becomes **KAD1SR**. For a head with 8R15 key, use the suffix **R1**.

(2) For separate marked legend ordering information, see pages 63 to 66.

(3) Heads **only** for use with bodies **K●●●●●X**, incorporating adaptor plate **KZ127**. See pages 32 to 60.

(4) To order:

- a head with key n° 455, replace the ● in the reference by 1. Example: **KAXZ1S131**,
- a head with key n° 421, replace the ● in the reference by 2. Example: **KAXZ1S132**,
- a head with key n° 520, replace the ● in the reference by 3. Example: **KAXZ1S133**,
- a head with a special key, replace the ● in the reference by 9. Example: **KAXZ1S139** (state the key number on the order).
Key withdrawal from all positions.

45 x 45 mm/1.77 x 1.77 in. legends - marked (1)

White text on black background

30°

KZ18033L



45°

KZ18041L



KZ18044L



KZ18045L



KZ18047L



KZ18048L



KZ18416L



KZ18419L



KZ18421L



KZ18434L



KZ18451L



60°

KZ18630L



KZ18634L



KZ18635L



90°

KZ18093L



Black text on yellow background

45°

KZ19041L



45 x 45 mm/1.77 x 1.77 in. legends - unmarked

Colour	Sold in lots of	Unit reference	Weight kg/lb
Black	20	KZ17L	0.003/0.007
Metallic	20	KZ18L	0.003/0.007

(1) Weight = 0.003 kg/0.007 lb.

Cam switches

Adaptable sub-assemblies, 12 and 20 A
Legends for Ø 22 mm HOLE mounting heads with plastic bezel

45 x 45 mm/1.77 x 1.77 in. legends - marked (1)

Black text on metallic background

30°

KZ18032



KZ18312



45°

KZ18041



KZ18043



KZ18044



KZ18045



KZ18046



KZ18048



KZ18416



KZ18417



KZ18418



KZ18420



KZ18421



KZ18434



KZ18451



60°

KZ18061



KZ18630



KZ18631



KZ18632



KZ18634



KZ18635



90°

KZ18093



KZ18913



Black text on yellow background

45°

KZ19041



45 x 45 mm/1.77 x 1.77 in.. legends - unmarked

Colour	Sold in lots of	Unit reference	Weight kg/lb
Black	20	KZ17	0.003/0.007
Metallic	20	KZ18	0.003/0.007

(1) Weight = 0.003 kg/0.007 lb.

Cam switches

Adaptable sub-assemblies, 12 and 20 A
 Legends for Ø 22 mm HOLE mounting heads
 with chromium plated metal bezel, type KAXZ1●●●

46 x 46 mm - marked (PVC) (1)

White text on black background

30°

XBCY2250

XBCY7238

XBCY7239



45°

XBCY7220

XBCY7223

XBCY7231



60°

XBCY7243



46 x 46 mm legends - unmarked (PVC)

Colour	Sold in lots of	Unit reference	Weight kg/lb
Black/red	10	KZ17X	0.004/0.009
White/yellow	10	KZ19X	0.004/0.009

(1) Weight = 0.004 kg/0.009 lb.

Cam switches

Adaptable sub-assemblies, 12 and 20 A

Legend holders for heads

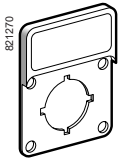

KZ13

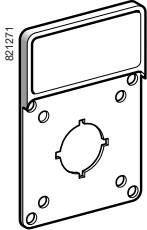

KZ15

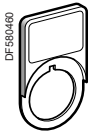

KZ01R

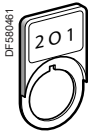

KZ2

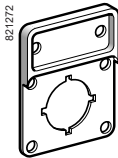

KZ14

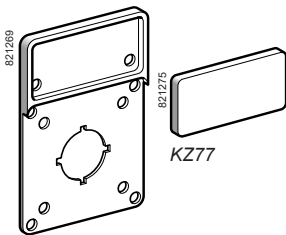

KZ16

Legend holders with and without legend

Description	For use with heads	Legend marking	Sold in lots of	Unit reference	Weight kg/lb
With blank legend	With 45 x 45 mm/1.77 x 1.77 in. front – plate (1)	–	5	KZ13	0.004/0.009
	With 60 x 60 mm/2.36 x 2.36 in. front plate (1)	–	5	KZ15	0.010/0.022
	Circular, with Ø 29 mm/1.14 in. collar	–	5	KZ01R	0.010/0.022
With marked legend	Circular, with Ø 29 mm/1.14 in. collar	2 0 1	5	KZ2	0.003/0.007
Without legend	With 45 x 45 mm/1.77 x 1.77 in. front plate (1)	–	20	KZ14	0.003/0.007
	With 60 x 60 mm/2.36 x 2.36 in. front plate (1)	–	10	KZ16	0.007/0.015

Blank legends (for engraving) for legend holders

Description	For use with heads	Sold in lots of	Unit reference	Weight kg/lb
Legend for legend holder KZ16 Plastic with metallic finish. Self-adhesive. For engraved markings.	With 60 x 60 mm/2.36 x 2.36 in. front plate (1)	10	KZ77	0.003/0.007

(1) Operating heads for single Ø 22 mm/0.87 in. hole or 4 hole mounting.

Cam switches

Complete switches, 12 and 20 A
Separate components and accessories

K142_638_CP00A2016035



KZ41H

KZ32C



KZ32

ODADG121450



KZ83

KZ127 image



KZ127

KZ140 image



KZ140

Handles					
Description	Colour	Dimensions mm/in.	Sold in lots of	Unit reference	Weight kg/lb
New shape	Red	35/1.38	5	KZ41H	0.007/0.015

Accessories					
Description	For use with	Dimensions mm/in.	Sold in lots of	Unit reference	Weight kg/lb
Door interlocking plate	Rear mounting switches	45 x 45/ 1.77 x 1.77	5	KZ32	0.010/0.022

Plate with rubber seal	Rear mounting switches. IP 65 between front plate and operating head	60 x 60/ 2.36 x 2.36	5	KZ83	0.018/0.040
------------------------	--	-------------------------	---	------	-------------

Adaptor plate, metal (replacement)	Mounting KAXZ1●●● chromium plated metal bezel heads on front mounting bodies for Ø 22 mm/0.87 in. hole	–	1	KZ127	0.088/0.194
------------------------------------	--	---	---	-------	-------------

Plastic plate (replacement)	Ø 22 mm/0.87 in. hole, front mounting, clip-in bodies	–	1	KZ140	0.010/0.022
-----------------------------	---	---	---	-------	-------------

Cam switches

Complete switches, 12 and 20 A

Separate components and accessories

Accessories (continued)					
Description	For use with	Sold in lots of	Unit reference	Weight kg/lb	
 ODAAG121443-bis KZ73	Rubber seals for IP 65 degree of protection	Ø 22 mm/0.87 in. or 4 hole, front mounting, operating heads with 45 x 45 mm/1.77 x 1.77 in. front plate	5	KZ65	0.003/0.007
		Ø 22 mm/0.87 in. or 4 hole, front mounting, operating heads with 60 x 60 mm/2.36 x 2.36 in. front plate	5	KZ66	0.004/0.009
		Multi-fixing operating heads with 45 x 45 mm/1.77 x 1.77 in. front plate	5	KZ73	0.004/0.009
 ODAZ01 Z01	Nut wrench	M22 fixing nuts	5	Z01	0.010/0.022
 ODAK293 KZ93	Mounting adaptor	Converting Ø 30.5 mm/1.20 in. fixing hole to Ø 22.5 mm/0.88 in.	50	KZ93	0.003/0.007
 PF 100885 ZBG455		Key 455	2	ZBG455	0.010/0.022
		Specific key	2	ZBGK (1)	0.014/0.031
 K1-K2_638_CP0DA2016030 KZ31	Quick assembly device	Mounting on 35 mm/1.38 in. rails to DIN 46277. 2 fixing screws included for rear mounting	5	KZ31	0.030/0.066
 P100009083 KZ91H	Cam switch installation kit Comprising:	Installation of a cam switch on a distribution panel	1	KZ91H	0.010/0.022
	- mounting plate, - 45 x 45 mm/1.77 x 1.77 in. front plate, without legend - black handle, length 35 mm/1.38 in. (KZ27H), - 2 fixing screws				

(1) Key number to be added when ordering.

Cam switches

Complete switches, 12 A with key operated lock
 Front mounting by 6 screws Ø 5.2 mm
 with 55 x 100 mm front plate

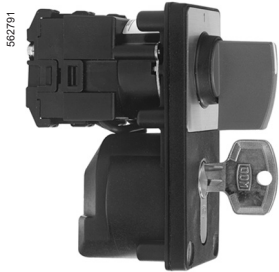

K1C003NZ2

Stepping switches (3 step), without "0" position

Wiring diagram and switching programme	Marking and switch position	Colour of handle	Reference	Weight kg/lb
--	-----------------------------	------------------	-----------	--------------

1-pole

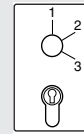
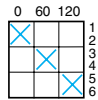
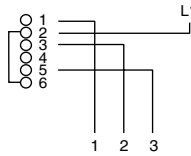

Red **K1C003NZ2** 0.170/0.374

2-pole

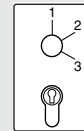
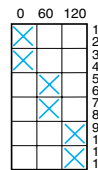
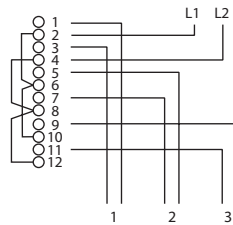

Black **K1F013NZ4** 0.170/0.374

Cam switches

Complete switches, 12 A with key operated lock
 Front mounting by 6 screws Ø 5.2 mm
 with 55 x 100 mm front plate

Stepping switches (4 step), 4-pole, without "0" position

Wiring diagram and switching programme	Marking and switch position	Colour of handle	Reference	Weight kg/lb
--	-----------------------------	------------------	-----------	--------------

4 step (1)

K1-K2_638_CP00A2016070



K1Q034NZ4

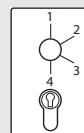
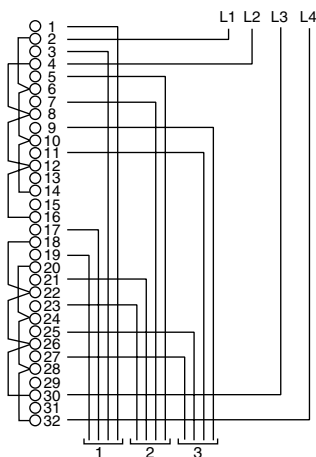

Red **K1Q034NZ2** 0.170/0.374

Black **K1Q034NZ4** 0.170/0.374

(1) Switching programme identical for 4 step and 4 step with intermediate steps at 30°.

Cam switches

Complete switches, 12 A with key operated lock
 Front mounting by 6 screws Ø 5.2 mm
 with 55 x 100 mm front plate



K1H032QZ4

Stepping switches (2 step), with "0" position

Wiring diagram and switching programme	Marking and switch position	Colour of handle	Reference	Weight kg/lb
--	-----------------------------	------------------	-----------	--------------

4-pole

Black **K1H032QZ4** 0.170/0.374

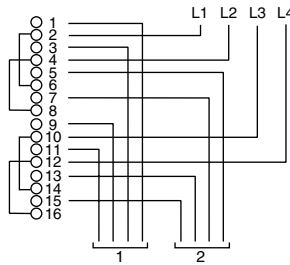

	0	60	120	
1		X		1
2			X	2
3				3
4				4
5		X		5
6			X	6
7				7
8				8
9		X		9
10			X	10
11				11
12				12
13		X		13
14			X	14
15				15
16				16

Cam switches

Complete switches, 12 A with key operated lock
 Front mounting by 6 screws Ø 5.2 mm
 with 55 x 100 mm front plate



K1K015NZ4

Stepping switches (5 step), 2-pole, with "0" position

Wiring diagram and switching programme	Marking and switch position	Colour of handle	Reference	Weight kg/lb
--	-----------------------------	------------------	-----------	--------------

5 step Black **K1K015NZ4** 0.170/0.374

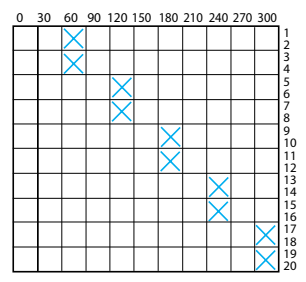
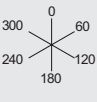
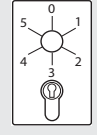
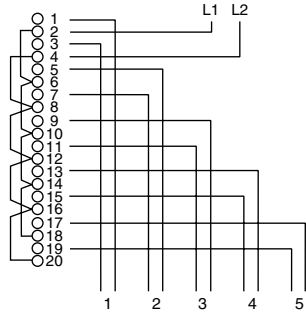

Cam switches

Complete switches, 12 A with key operated lock
 Front mounting by 6 screws Ø 5.2 mm
 with 55 x 100 mm front plate



K1B001UZ2

Changeover switches with "0" position

Wiring diagram and switching programme	Marking and switch position	Colour of handle	Reference	Weight kg/lb
<p>1-pole</p>		Black	K1B001UZ4	0.170/0.374
<p>3-pole</p>		Black	K1F003UZ4	0.170/0.374

Cam switches

Switches mounted in plastic enclosure, 10



KD●●●●●G

OFF-ON switches in enclosure

Specifications

- PVC enclosure.
- 60 x 60 mm/2.36 x 2.36 in. operating head, black handle (without padlocking device) on metallic background. Marking: O I.
- Legend holder with metallic finish blank legend.
- Protection degree (conforming to standard EN/IEC 60529): IP 65.

Composition (1)				Dimensions w x h x d (2)	Thermal current (Ithe) (3)	Reference	Weight
Poles	N	N/O	N/C				
3	-	-	-	74 x 135 x 106/ 2.91 x 5.31 x 4.17	10	KD1C051G	0.390/0.860

(1) Poles : main contacts

- N/O contact : late make (unballasting contact)
- N/C contact : signaling contact
- Neutral conductor (N) : early make, late break.

(2) Total depth, including operating head.

(3) Permissible power, AC-23 at 400 V :

- K1 switches : 2.2 kW,
- K2 switches : 5.5 kW.

Cam switches

Complete switches, 32 to 150 A

The range of K30 to K150 cam switches (32 to 150 A ratings) comprises only complete switches. These products are more specifically designed for direct control of simple machines.

Complete switches

- switches
- stepping switches
- changeover switches
- voltmeter switches
- ammeter switches
- starting switches

Front mounting

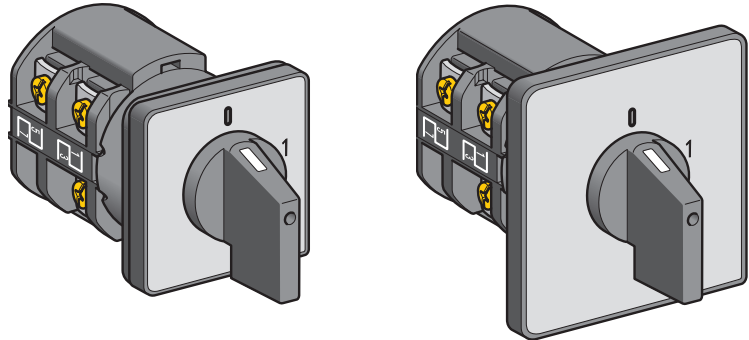

By 4 holes
with 64 x 64 mm/2.52 x 2.52 in. front plate
32 to 63 A ratings
K30, K50 and K63

By 4 holes
with 88 x 88 mm/3.46 x 3.46 in. front plate
115 to 150 A ratings
K115 and K150

"Multi-fixing" mounting

Rear mounting

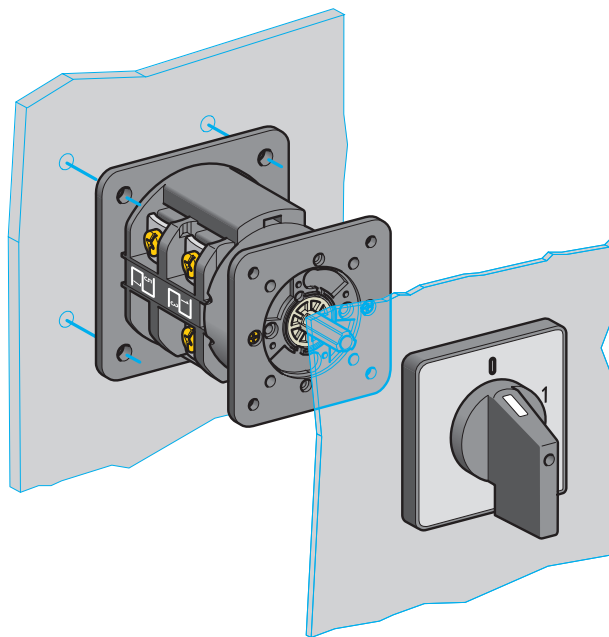

By 4 holes on 48 mm/1.89 in. centres
32 to 63 A ratings
K30, K50 and K63

By 4 holes on 68 mm/2.68 in. centres
115 to 150 A ratings
K115 and K150

Cam switches

Complete switches, 32 to 150 A

With 64 x 64 mm front plate (32 to 63 A ratings)
and 88 x 88 mm front plate (115 and 150 A ratings)



K30C003AP



K50C003AP

Switches with 60° switching angle

Front mounting

Wiring diagram and switching programme	Marking and switch position	Number of poles	Thermal current (Ith) A	Reference	Weight kg/lb
		1	32	K30A001AP	0.130/0.287
		2	32	K30B002AP	0.170/0.375
		50	K50B002AP	0.215/0.474	
		3	32	K30C003AP	0.224/0.494
		50	K50C003AP	0.275/0.606	
		63	K63C003AP	0.345/0.761	
		115	K115C003AP	0.680/1.499	
		4	32	K30D004AP	0.250/0.551
		63	K63D004AP	0.390/0.860	

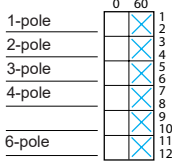

Cam switches

Complete switches, 32 to 150 A

With 64 x 64 mm front plate (32 to 63 A ratings)
and 88 x 88 mm front plate (115 and 150 A ratings)

Switches with 90° switching angle

Front mounting

Wiring diagram and switching programme	Marking and switch position	Number of poles	Thermal current (Ith) A	Reference	Weight kg/lb
		3	32	K30C003HP	0.224/0.494
			50	K50C003HP	0.275/0.606
			63	K63C003HP	0.345/0.761
		4	32	K30D004HP	0.250/0.551
			50	K50D004HP	0.305/0.672
			63	K63D004HP	0.390/0.860
			115	K115D004HP	0.745/1.642
		150	K150D004HP	0.880/1.940	



K63C003HP



K150D004HP

Cam switches

Complete switches, 32 to 150 A
 With 64 x 64 mm front plate (32 to 63 A ratings)
 and 88 x 88 mm front plate (115 and 150 A ratings)



K30B001UP

Changeover switches with "0" position

Front mounting						
Wiring diagram and switching programme	Marking and switch position	Number of poles	Thermal current (Ith) A	Reference	Weight kg/lb	
		1	32	K30B001UP	0.170/0.375	
			150	K150B001UP	0.790/1.742	
		2	32	K30D002UP	0.250/0.551	
			50	K50D002UP	0.305/0.672	
		3	32	K30F003UP	0.425/0.937	
			50	K50F003UP	0.530/1.168	
			63	K63F003UP	0.590/1.301	
			115	K115F003UP	0.645/1.422	
			150	K150F003UP	0.760/1.675	
		4	32	K30H004UP	0.485/1.069	
			50	K50H004UP	0.610/1.345	
			63	K63H004UP	0.680/1.499	
			115	K115H004UP	0.750/1.653	
			150	K150H004UP	0.880/1.940	



K63F013UP

Changeover switches without "0" position

Front mounting						
Wiring diagram and switching programme	Marking and switch position	Number of poles	Thermal current (Ith) A	Reference	Weight kg/lb	
		3	32	K30F013UP	0.425/0.937	
			50	K50F013UP	0.530/1.168	
			63	K63F013UP	0.590/1.301	
			115	K115F013UP	0.645/1.422	
			150	K150F013UP	0.760/1.675	
		4	32	K30H014UP	0.485/1.069	
			50	K50H014UP	0.610/1.345	
			63	K63H014UP	0.680/1.499	
			115	K115H014UP	0.750/1.653	
			150	K150H014UP	0.880/1.940	

Cam switches

Complete switches, 32 to 150 A

With 64 x 64 mm front plate (32 to 63 A ratings)
and 88 x 88 mm front plate (115 and 150 A ratings)

Star-delta switches

Front mounting

10352



K50H001YP

Wiring diagram and switching programme	Marking and switch position	Number of poles	Thermal current (Ith) A	Reference	Weight kg/lb
		3	32	K30H001YP	0.485/1.069
			50	K50H001YP	0.610/1.345
			63	K63H001YP	0.680/1.499

Reversing star-delta switches

Front mounting

50177



K115K006YP

			50	K50K006YP	0.690/1.521
			115	K115K006YP	0.880/1.940

Cam switches

Complete switches, 32 to 150 A
 With 64 x 64 mm front plate (32 to 63 A ratings)
 and 88 x 88 mm front plate (115 and 150 A ratings)
 Accessories

Pole change switches for 2-speed motors (for motors with tapped "Dahlander" windings)

Front mounting						
Wiring diagram and switching programme	Marking and switch position	Number of poles	Thermal current (Ith) A	Reference	Weight kg/lb	
		3	32	K30H004PP	0.485/1.069	
			50	K50H004PP	0.610/1.345	
			63	K63H004PP	0.680/1.499	



K63H004PP

Reversing switches with "0" position

Front mounting						
Wiring diagram and switching programme	Marking and switch position	Number of poles	Thermal current (Ith) A	Reference	Weight kg/lb	
		2	50	K50D002WP	0.305/0.672	
			150	K150D002WP	0.880/1.940	
		3	32	K30E003WP	0.385/0.849	
			50	K50E003WP	0.485/1.069	
			63	K63E003WP	0.540/1.190	

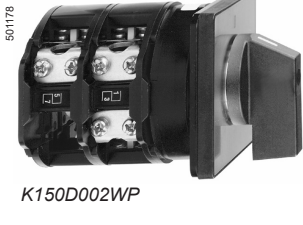

K150D002WP

K	
K10A001ACH	9
K10B001UCH	12
K10B002ACH	9
K10B002QCH	9
K10B006TCH	11
K10B011UCH	12
K10C003ACH	9
K10C003NCH	10
K10C003QCH	9
K10D002UCH	12
K10D004ACH	9
K10D004NCH	10
K10D004QCH	9
K10D012QCH	10
K10D012UCH	12
K10D024MCH	13
K10F003MCH	13
K10F003UCH	12
K10F013NCH	11
K10F013QCH	10
K10F013UCH	12
K10F027MCH	13
K10H004UCH	12
K10H014UCH	12
K115C003AP	76
K115D004HP	77
K115F003UP	78
K115F013UP	78
K115H004UP	78
K115K006YP	79
K150B001UP	78
K150D002WP	80
K150D004HP	77
K150F003UP	78
K150F013UP	78
K150H004UP	78
K150H014UP	78
K1A001ACH	18
K1A001ALH	18
K1A001TCH	19
K1A002TLH	19
K1B001UCH	27
K1B001ULH	27
K1B001UZ4	73
K1B002ACH	18
K1B002ALH	18
K1B002B	39
K1B002NCH	22
K1B002QLH	21
K1B003B	39
K1B003BL	39
K1B006TCH	27
K1B006TLH	27
K1B011UCH	27
K1B011ULH	27
K1B023B	40
K1B1002HCH	18
K1B1002HLH	18
K1C003ACH	18
K1C003ALH	18
K1C003HCH	18
K1C003NCH	22
K1C003NLH	22
K1C003NZ2	69
K1C003QCH	21
K1C003QLH	21
K1C005BL	39
K1C006B	39
K1C006BX	39
K1C007B	39
K1C025B	40
K1C025BX	40
K1C026B	40
K1C027B	41
K1C027BX	41
K1D002UCH	27
K1D002ULH	27
K1D004NCH	22
K1D004NLH	22
K1D004QCH	21
K1D004QLH	21
K1D008BL	39
K1D009B	40
K1D009BL	40
K1D011B	40
K1D012NLH	24
K1D012UCH	27
K1D012ULH	27
K1D024M	54
K1D024MCH	31
K1D024MLH	31
K1D028BL	41
K1D028BX	41
K1D030B	41
K1D030BL	41
K1D031B	41
K1D032B	41
K1D034MCH	31
K1E005NCH	22
K1E005NLH	22
K1E005QCH	21
K1E005QLH	21
K1E035MCH	31
K1E035MLH	31
K1F003M	53
K1F003MCH	28
K1F003MLH	28
K1F003UCH	27
K1F003ULH	27
K1F003UZ4	73
K1F006ACH	18
K1F013MCH	28
K1F013NCH	24
K1F013NLH	24
K1F013NZ4	69
K1F013QCH	23
K1F013QLH	23
K1F013UCH	27
K1F013ULH	27
K1F022NLH	26
K1F027M	55
K1F027MCH	30
K1F027MLH	30
K1F037MCH	30
K1F037MLH	30
K1H004UCH	27
K1H004ULH	27
K1H014MLH	29
K1H014NCH	24
K1H014NLH	24
K1H014QCH	23
K1H014QLH	23
K1H014UCH	27
K1H014ULH	27
K1H026MLH	30
K1H032QZ4	71
K1I023NCH	26
K1I023NLH	26
K1I023QCH	25
K1I023QLH	25
K1K015NCH	24
K1K015NZ4	72
K1K015QCH	23
K1Q034NZ2	70
K1Q034NZ4	70
K2A001ACH	18
K2A001ALH	18
K2A001TCH	19
K2B001UCH	27
K2B001ULH	27
K2B002ACH	18
K2B002ALH	18
K2B004TCH	20
K2B004TLH	20
K2B011ULH	27
K2B1002HCH	18
K2B1002HLH	18
K2C003ACH	18
K2C003ALH	18
K2C003HCH	18
K2C003HLH	18
K2C003NLH	22
K2C003QCH	21
K2C003QLH	21
K2D002UCH	27
K2D002ULH	27
K2D004ALH	18
K2D004HLH	18
K2D004QLH	21
K2D012UCH	27
K2D012ULH	27
K2E005ALH	18
K2E005QLH	21
K2F003UCH	27
K2F003ULH	27
K2F006ACH	18
K2F006ALH	18
K2F013NLH	24
K2F013UCH	27
K2F022QLH	25
K2G003Y	58
K2H001Y	58
K2H004UCH	27
K2H004ULH	27
K2H014ULH	27
K2K006Y	58
K2K015NCH	24
K2K015QLH	23
K30A001AP	76
K30B001UP	78
K30B002AP	76
K30C003AP	76
K30C003HP	77
K30D002UP	78
K30D004AP	76
K30D004HP	77
K30E003WP	80
K30F003UP	78
K30F013UP	78
K30H001YP	79
K30H004PP	80
K30H004UP	78
K30H014UP	78
K50B002AP	76
K50C003AP	76
K50C003HP	77
K50D002UP	78
K50D002WP	80
K50D004HP	77
K50E003WP	80
K50F003UP	78
K50F013UP	78
K50H001YP	79
K50H004PP	80
K50H004UP	78
K50H014UP	78
K50K006YP	79
K63C003AP	76
K63C003HP	77
K63D004AP	76
K63D004HP	77
K63E003WP	80
K63F003UP	78
K63F013UP	78
K63H001YP	79
K63H004PP	80
K63H004UP	78
K63H014UP	78
KAA1H	62
KAA1S	62
KAA1Z	62
KAA2H	62
KAC1H	61
KAC1H41	61
KAC1H48	61
KAC1S	61
KAD1H	61
KAD1S	62
KAE1H	62
KAG3H	61
KAXZ1C12	62
KAXZ1C14	62
KAXZ1M12	62
KBA1H	62
KBA1S	62
KBC1H	61
KBC1H48	61
KBC1H61	61
KBC1S	61
KBC1Z	61
KBD1H	61
KBD1S	62
KBD1Z	62
KBE1H	62
KBF1H	62
KBG3H	61
KCC1LH	61
KCC1Y	61
KCD1MH	61
KCE1LH	62
KCG3H	61
KCG3Y	61
KD1C051G	74
KDC1H	61

KDC1S	61	KZ18634L	63
KDC1Z	61	KZ18635	64
KDD1H	61	KZ18635L	63
KDD1S	62	KZ18913	64
KDE1H	62	KZ18L	63
KDF1H	62	KZ19041	64
KDG3H	61	KZ19041L	63
KDG3Y	61	KZ19X	65
KZ01R	66	KZ2	66
KZ127	67	KZ31	68
KZ13	66	KZ32	67
KZ14	66	KZ41H	67
KZ140	67	KZ65	68
KZ15	66	KZ66	68
KZ16	66	KZ73	68
KZ17	64	KZ77	66
KZ17L	63	KZ83	67
KZ17X	65	KZ91H	68
KZ18	64	KZ93	68
KZ18032	64	X	
KZ18033L	63	XBCY2250	65
KZ18041	64	XBCY7220	65
KZ18041L	63	XBCY7223	65
KZ18043	64	XBCY7231	65
KZ18044	64	XBCY7238	65
KZ18044L	63	XBCY7239	65
KZ18045	64	XBCY7243	65
KZ18045L	63	Z	
KZ18046	64	Z01	68
KZ18047L	63	ZBG455	68
KZ18048	64	ZBGK	68
KZ18048L	63		
KZ18061	64		
KZ18093	64		
KZ18093L	63		
KZ18312	64		
KZ18416	64		
KZ18416L	63		
KZ18417	64		
KZ18418	64		
KZ18419L	63		
KZ18420	64		
KZ18421	64		
KZ18421L	63		
KZ18434	64		
KZ18434L	63		
KZ18451	64		
KZ18451L	63		
KZ18630	64		
KZ18630L	63		
KZ18631	64		
KZ18632	64		
KZ18634	64		

Life Is On



Learn more about our products at
www.se.com

The information provided in this documentation contains general descriptions and/or technical characteristics of the performance of the products contained herein. This documentation is not intended as a substitute for and is not to be used for determining suitability or reliability of these products for specific user applications. It is the duty of any such user or integrator to perform the appropriate and complete risk analysis, evaluation and testing of the products with respect to the relevant specific application or use thereof. Neither Schneider Electric nor any of its affiliates or subsidiaries shall be responsible or liable for misuse of the information contained herein.

Design: Schneider Electric
Photos: Schneider Electric

Schneider Electric Industries SAS

Head Office
35, rue Joseph Monier - CS 30323
F-92500 Rueil-Malmaison Cedex
France

DIA5ED2130604EN
January 2023 - V2.0