



ENGLISH

Product Datasheet

C Hook Wrench 32~76mm



Specifications:

Chrome vanadium hardened steel.

Tempered C-hook wrenches are specially designed for using with slotted retaining rings.

4mm thin hook allows to access confined areas in motorcycle steering and suspension.

Material: S45C

Dimensions:

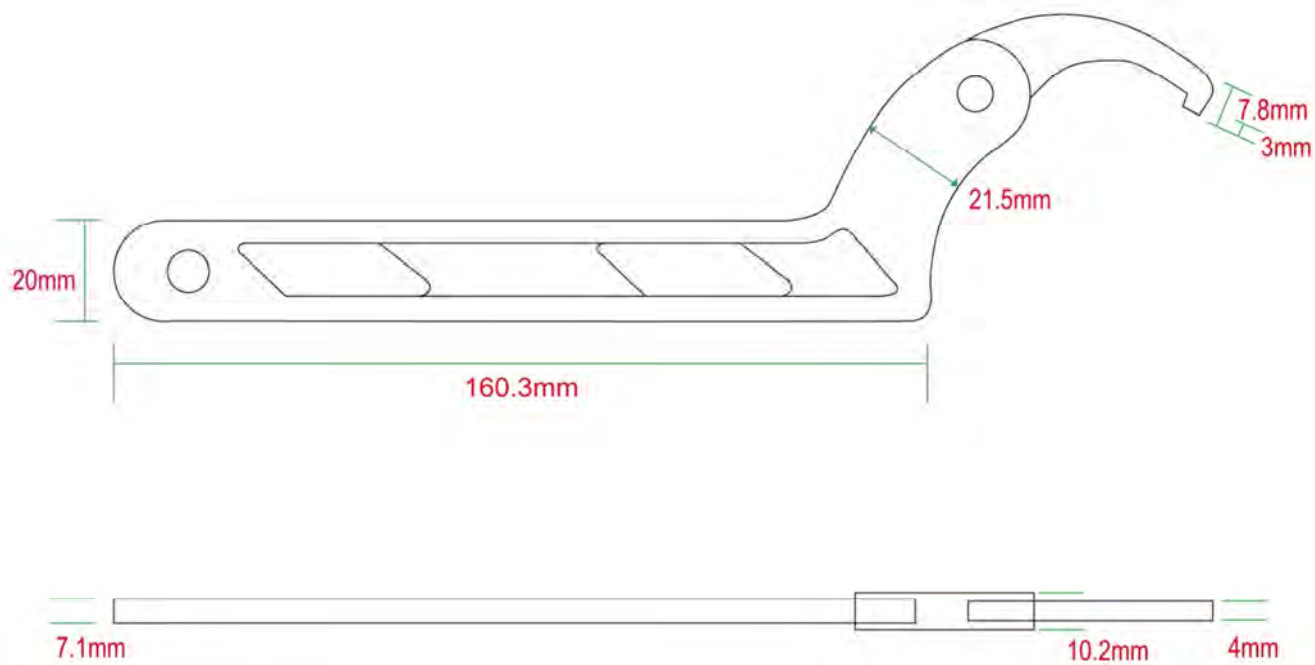

Operating Instructions:

