

Features

- For Use With:
Universal
Rectangular Alu
- Mounting: PCB
Mount
- Thermal Resistance
7.00°C/W

RS PRO Heatsinks

RS Stock No.: 2342362

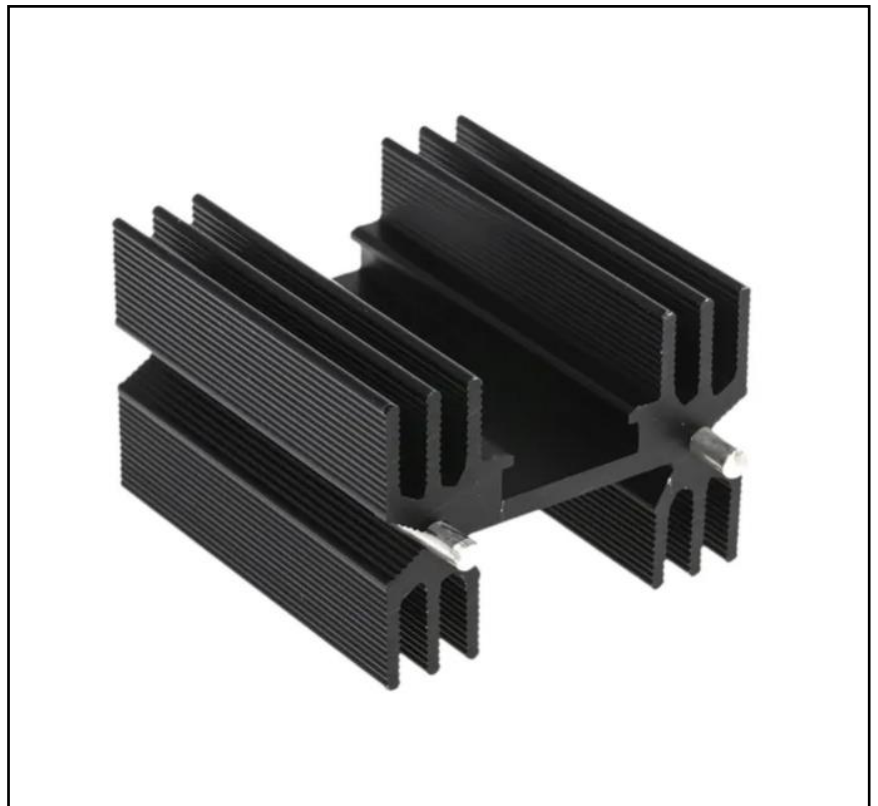

RS PRO Professionally Approved Products bring to you professional quality parts across all product categories. Our product range has been tested by engineers and provides a comparable quality to the leading brands without paying a premium price.

Product Description

The RS PRO Heatsink is suitable for use with universal square Alu. Its material Aluminium. Thermal resistance quoted is with fins vertical in free air. Length dimension refers to extrusion length along fins.

General Specifications

For Use With	Universal Rectangular Alu
Material	Aluminium
Mounting	PCB Mount
Application	High Power Semiconductor Device, Optoelectronic Device
Finish	Anodized
Notes	<ul style="list-style-type: none">• Thermal Resistance is calculated based on a distributed heat load and vertically mounted fins anodised heatsink with a 60°C temperature.• Under general operating conditions the thermal mounting arrangement of the device is not know and therefore the figures should be used as a guide to selection.• We recommend that the effectiveness of any heatsink is tested in the specific operating environment in which it will be subjected.

Mechanical Specifications

Length	38mm
Width	35mm
Height	25mm
Dimension	38 x 35 x 25mm

Electrical Specifications

Thermal Resistance	7.00°C/W
--------------------	----------

Drawing below is for illustration purposes only. If any further information is required please contact us.

