

FEATURES

- Rated Voltages 415V a.c./120V d.c., 500V a.c./
- Breaking Capacities 100kA a.c. 100kA d.c.
- Breaking Range and Utilisation Category gG

RS PRO NH TYPE FUSE-LINKS WITH CENTRED TAG BLADES

RS Stock No.: 2213678, 2213679



RS Professionally Approved Products bring to you professional quality parts across all product categories. Our product range has been tested by engineers and provides a comparable quality to the leading brands without paying a premium price.

Centered Tag Fuses

Product Description

415 Volt NH Industrial Fuse-Links with knife blade contacts are for use in industrial installations. Type "LSPN/DIN" are used for protection of conductors.

NH fuse-links are manufactured from a rectangular ceramic casing surrounded by a cover plate with a metal blade style terminal on each end. As a result of blown fuse-link, they must be replaced with a new fuse with the same characteristics. The fuse element inside the casing is connected to the cover plate / blade terminals.

Also available: Ranges of Fuse-Links for motor circuit and semi-conductor protection

General Specifications

Current Rating	63A
Voltage Rating	415V ac
Fuse Standard	IEC 60269-2
Overall Length	78.5 mm
Body Width	21 mm
Body Length	54 mm

Approvals

Standards Met	IEC 60269-2
---------------	-------------

Similar Products

Stock No.	Brand	Voltage Rating a.c. Volt	Current Rating Amps
(221-3671)	RS PRO	415	25
(221-3673)	RS PRO	415	32
(221-3676)	RS PRO	415	50
(221-3681)	RS PRO	415	80

Centered Tag Fuses

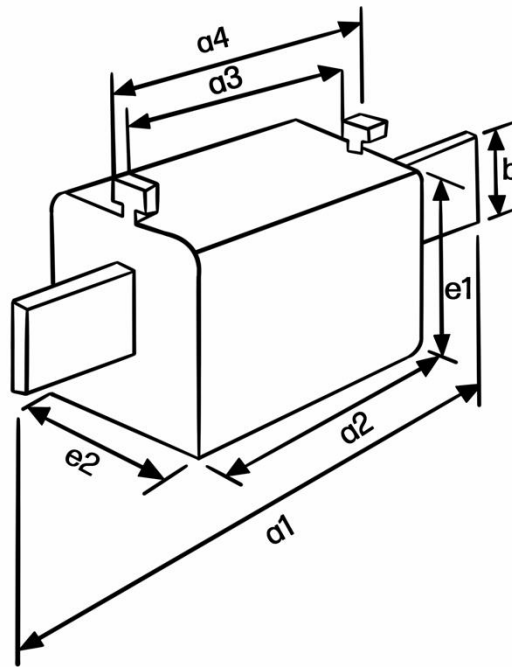

Size	List Reference	Current Rating (A)	Dimensions (mm)						
			a1	a2	a3	a4	b	e1	e2
000	LSPN 000	6,10,16,20,25,32,40,50,63	78.5	54	45	49	15	35	21
00	LSPN 00	10,16,20,25,32,40,50,63,80,100,125,160	78.5	54	45	49	15	43	30
0	LSPN 0	32,40,50,63,80,100,125,160	125	68	62	68	15	48	40
1	LSPN 1	32,40,50,63,80,100,125,160,200,250	135	75	62	68	25	46	46
2	LSPN 2	40,50,63,80,100,125,160,200,250,315,350,400	150	75	62	68	30	57	57
3	LSPN 3	315,400,500,630	150	75	62	68	35	72	72