

Datasheet

LED Indicator Lamp

RS ITEM NO 206-637

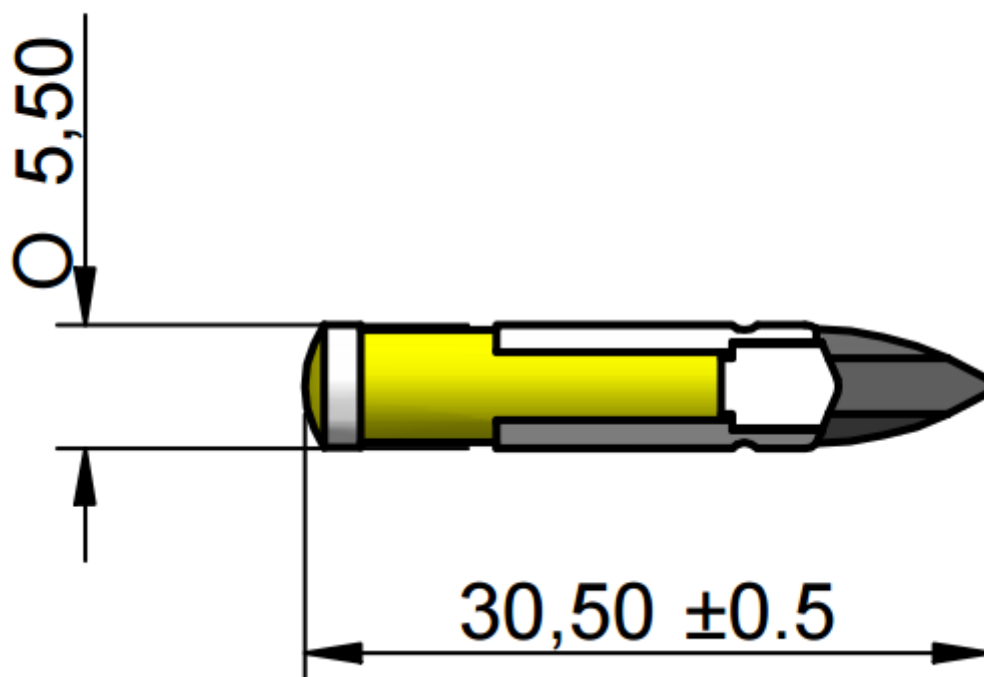

LED/Multiled	Multiled	Optimum voltage (V)	24vdc	Intensity	63mcd
Mounting Size		Rectifier			
Mounting Finish		AC current			
Protection		DC current	15mA		
Mount Holder	T5.5 Slide	Voltage Tolerance(%)	10%		
Chip Qty	6	Optimum temperature (°C)	-30°C...+60°C		
Indicator colour	Yellow	Storage temperature (°C)	-30°C...+60°C		
Wavelength (nm)	585	Contact Tab x 2	T5.5 Slide Base		



Dimension in mm (typical), not to scale.
We reserve the right to make changes without further notice to this product to improve reliability, function or design.