



Product Datasheet

Anti-Vandal Switch

Switch Pushbutton Stainless Momentary

ENGLISH

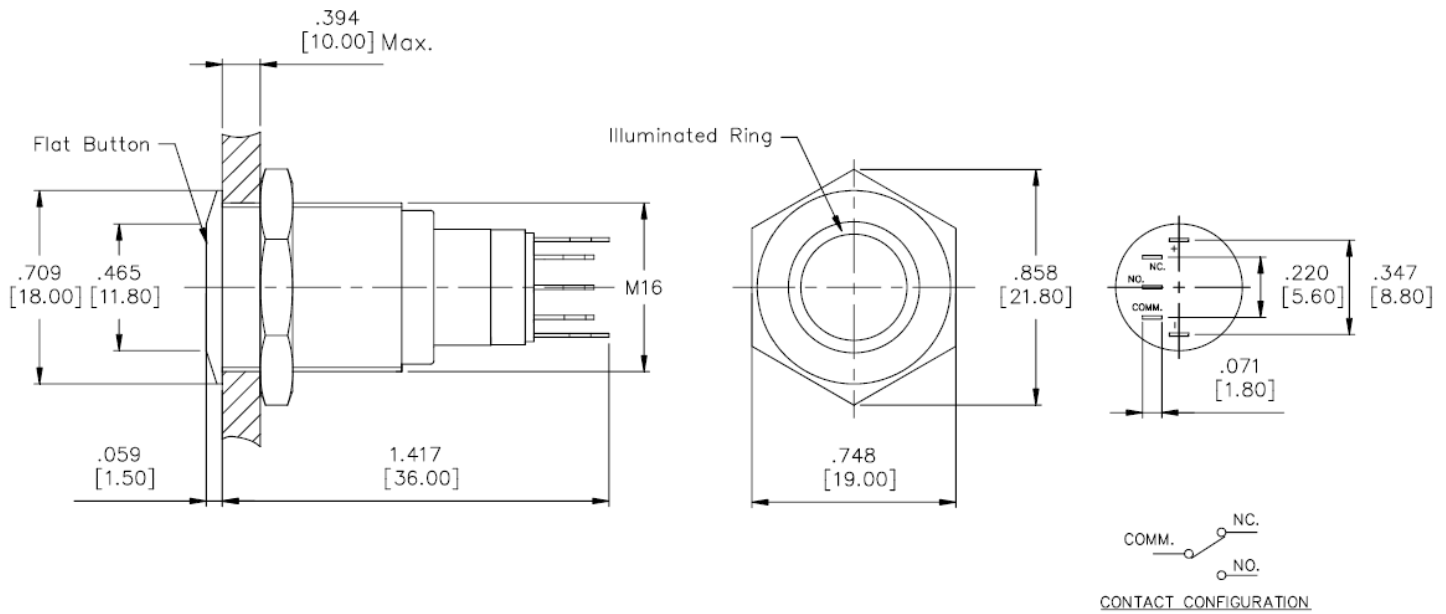



Package Contain:

- 1 x Anti-Vandal Switch
- 1 x Hex Nuts
- 1 x O-Ring

Specification:

SWITCH TYPE:		8118468
POLES/THROWS:		SPDT
SWITCH FUNCTIONS:		Illuminated, ON-MOM
ELECTRICAL CHARACTERISTICS	CONTACT RATING:	MAX. 3Amps @ 250VAC
	ELECTRICAL LIFE:	50,000 make-and-break cycles at full load
	CONTACT RESISTANCE:	50m-ohms max. initial @ 2-4VDC, 100mA
	INSULATION RESISTANCE:	Apply 500VDC for 1min±5sec. After which measurement to be made b/w terminals shall result 1000M-ohms min.
	DIELECTRICAL STRENGTH:	2,000VAC (50Hz-60Hz) RMS @ sea level shall result no damage to parts arcing or flashover
	OPERATING TEMPERATURE:	-20Celsius degree to +55Celsius degree
RELAIBILITY PERFORMANCE	MECHANICAL LIFE:	Without load, 50,000cycles min.
	OPERATING FORCE:	4N max.
	TORQUE:	5~14Nm max. applied to nut
	IP PROTECTION CLASS:	Front panel protection to IP67
	SOLDERING HEAT RESISTANCE:	Max soldering temperature @ 260Celsius degree, immersion time 5+/-1sec, frequency of soldering process @ 2 times max.
	COLD TEST:	Stored at temperature -20(+/-3)Celsius degree for 48 hours, shall result no changes to switch's electrical performance
	HOT TEST:	Stored at temperature +55(+/-3)Celsius degree for 48 hours, shall result no changes to switch's electrical performance
	HUMIDITY TEST:	Stored at temperature 40(+/-3)Celsius degree with relative humidity 90%~95% for 48 hours, shall result no changes to switch's electrical performance
	TORQUE:	5~14Nm max. applied to nut
	OPERATING FORCE:	4N max.



MATERIAL CHARACTERISTICS	BUTTON:	B32 : Stain less steel with varnished polished	
	BUSHING:		
	BASE:		PBT
	PLUNGER:		POM
	SPRING:		Steel wire
	CONTACT:		Copper alloy, silver plated
	TERMINALS:		Brass, silver plated
	HARDWARE:		Nut (Brass, nickel plated)
	LED:		White,(AC/DC Compatible) Voltage & Rating: 24V@ 15mA
SOLDERING & CLEANING RECOMMENDATION	HAND SOLDERING:	Max. temperature @ 320Celsius degree (662F)with continuous soldering time @ 2sec. max.	
	CLEANING PROCESS:	Noted, the switch is "not totally sealed" so it is important not to immerse/spray or clean unsealed areas of the switch during flux removal. Improper cleaning could cause switch deficiencies such as intermittence or open contact failures	
PACKAGE	INTERNAL PACKAGING:	1pcs per PE bag	
	RoHS IDENTIFI-CATIONS:	A label marking "RoHS compliant" will be attached to the carton box.	