

RS Pro M12 Connector Female, 8W-8C, 5m, PVC, Shield

RS Stock No: 144-7660

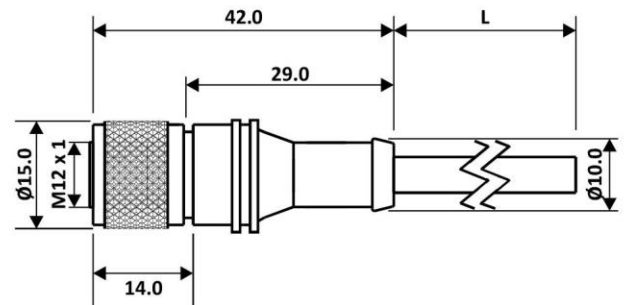

All dimensions are in mm.

General Specification

Rated Operational Voltage	30 V
Current Rating	2A
Insulation Resistance	>= 100 MΩ
Temperature Range	-25°C ... +75°C
Degree of Protection	IP67

Pin Assignment

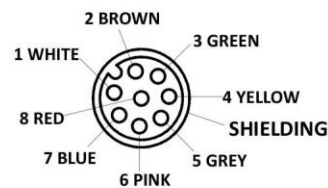

Material Specification

Grip Material	PU
Contact	Cu-Zn
Contact Plating	Gold Plated
Contact Carrier	Nylon 66
O-Ring	Neoprene
Grip Colour	Black
Coupling Nut	Brass Nickel-Plated

Cable Specification

Cable Length-L	5 m
Cable Type	8 Core PVC Multi Strand
Sheath Colour	Black
Cross Section of Wire	0.25 sq. mm
Core Dia	As per Manufacturer Specs.
Cable Dia	As per Manufacturer Specs.
Termination	Partially Stripped
Shield Details	Braiding (80%)