

Product Datasheet

Din Rail mini Terminal Blocks, 6sq.mm

Screw Clamp mini Terminal Blocks, 50A, 600V, 26-8 AWG, 0.5-6 sq.mm

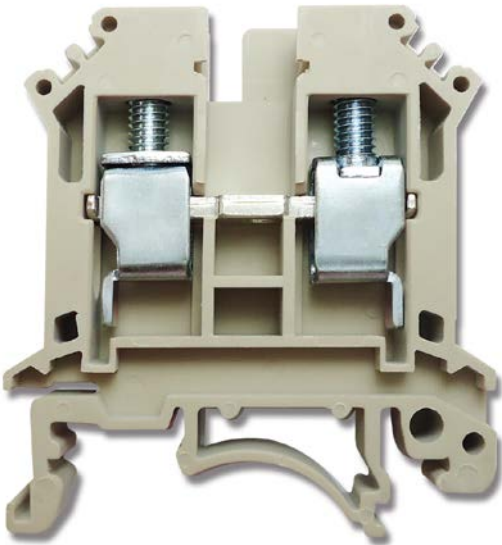



878-7538

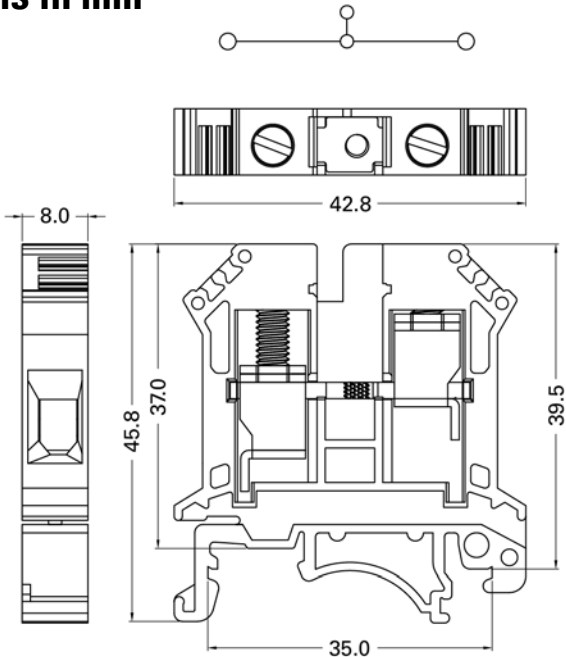

Dimensions in mm

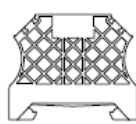

Product Specifications:

Specifications	6mm ²
Technical Date	Rated voltage / Rated current / Wire size
UL	600V / 50A / AWG 26-8
CSA	600V / 50A / AWG 26-8
IEC	800V / 57A / 0.5-6mm ²
Insulating impulse voltage withstand/pollution degree	8KV / 3
Torque (in -lbs)	14
Clamping Screw (M)	M4
Insulation stripping length (mm)	10~12 mm
Net weight per piece	13.6 g
Material / Available Color (Standard Color: Beige)	 Red Orange Beige Blue Grey White Black
Rail Dimensions	T / W / H (mm)
For TS35x7.5 	8 x 42.5 x 47
For TS35x15 	8 x 42.5 x 54.5
Accessories	Cat. No.
End Bracket 	8787553
	8787556
End plate 	8787540