

Datasheet

ENGLISH

RS PRO DC Motor, 7.85 W, 6 - 15 V, 6539 gcm, 84 rpm, 6mm Shaft Diameter

Stock No: 752-1964



Specifications:

Output Speed	84 rpm
Supply Voltage	6 - 15 V dc
Maximum Output Torque	6539 g.cm
DC Motor Type	Brushed
Shaft Diameter	6mm
Power Rating	7.85 W
Gearhead Type	Planetary
Length	73.9mm
Width	32 (Dia.) mm
Current Rating	990 mA
Weight	211g

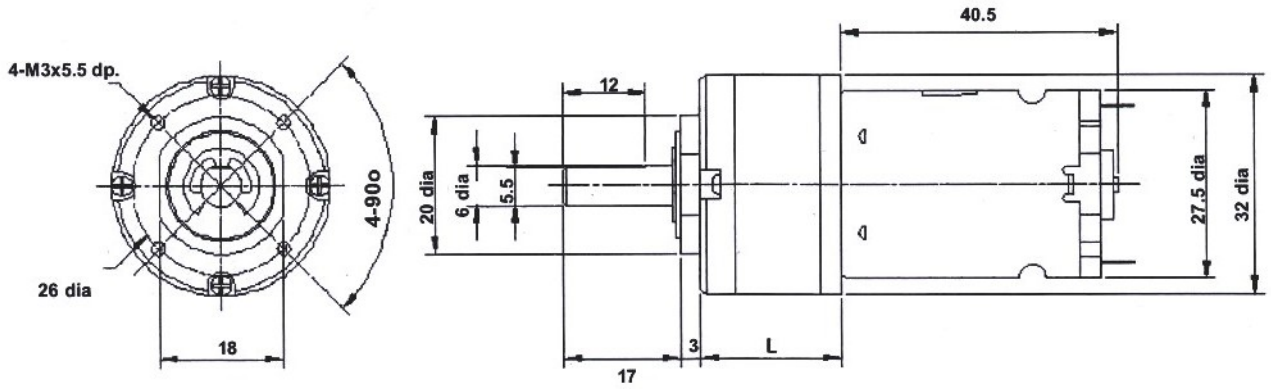

Ratio	L
139:1	33.4mm

Gearbox Housing material	Metal
Backlash at no-load	< 2.5°
Bearing at output	Sleeve bearings
Radial load (10mm from flange)	< 3 kgf
Shaft axial load	< 2.5 kgf
Shaft press fit force max	< 10 kgf
Radial play of shaft	< 0.08mm
Thrust play of shaft	< 0.3mm

Reduction Ratio	Rated tolerance Torque	Max momentary Tolerance Torque	Efficiency
1/139	10.0 kgf-cm Max.	30.0 kgf-cm	60%

Reduction Table RPM SUPPLY VOLTAGE	4.5v	6v	9v	12v	15v
752-1964	31	42	63	84	104

Note: Motor speeds may vary by (+) or (-) 12.5%