

Datasheet

Stock No: 286-3588

RS Pro Cast Iron 131 Wall Flange, 33.7mm Round Tube, Type 1



Product Details

Wall Flange

For fixing a top or middle rail to a wall

Dimensions (mm)				
Tube Size Ref.		E	F	G
1	89	9	45	64
2	102	9	51	76
3	114	9	57	89

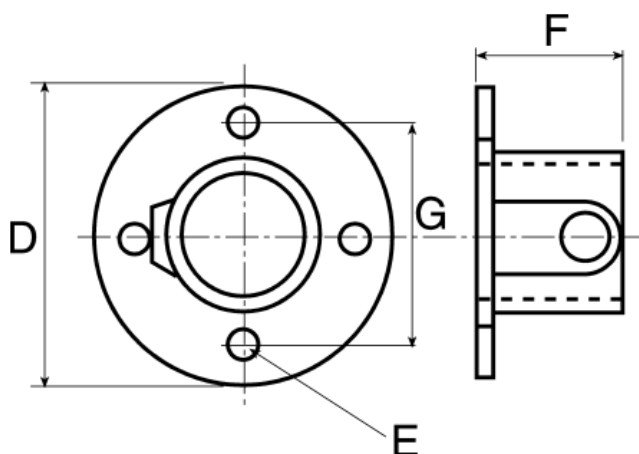



ENGLISH

Specifications:

Component Type	Wall Flange
Structural Element Type	Round Tube
Product Family	RS Handrail System
Product System	131
Fits Round Tube Size	Type 1
Fits Tube Diameter	33.7mm
Fits Strut Profile	Type 1
Material	Cast Iron