



EZM-9950 96 x 96 1/4 DIN Universal Input Programmable Timer & Counter with Output Module System

- 6 digits Process (PV) and 6 digits Set (SV) Value Display
- Operation with 2 Set Value
- Reset , Pause and ChA-ChB Counting Inputs
- Configurable Counter / "Totalizer Counter", Batch Counter , Timer, Chronometer , Frequncymeter and Tachometer Functions
- Programmable Time Bases for Timer and Chronometer (Second , Minute , Hour)
- Operation with Automatic and Manual Reset
- Output Module System
- NPN/PNP Type Operation
- INC , DEC , INC / INC , INC / DEC , UP / DOWN , x1 / x2 / x4 Counting with Phase Shifting Property in Counter Function
- Multiplication Coefficient and Decimal Point Position
- Different Alarm Alternatives in Frequncymeter and Cycle Measuring Functions
- Absolute or Offset Operation in Counter Function
- RS-232 (standard) or RS-485 (optional) Serial Communication with Modbus ASCII or RTU Protocol

ABOUT INSTRUCTION MANUAL

Instruction manual of EZM-9950 Programmable Timer&Counter consists of two main sections. Explanation of these sections are below. Also, there are other sections which include order information and technical specifications of the device. All titles and page numbers in instruction manual are in “**CONTENTS**” section. User can reach to any title with section number.

Installation:

In this section, physical dimensions of the device, panel mounting, electrical wiring, module mounting in the device, physical and electrical installation of the device to the system are explained.

Operation and Parameters:

In this section, user interface of the device, how to access to the parameters, description of parameters are explained.

Also in these sections, there are warnings to prevent serious injury while doing the physical and electrical mounting or using the device.

Explanation of the symbols which are used in these sections are given below.



This symbol is used for safety warnings. User must pay attention to these warnings.



This symbol is used to determine the dangerous situations as a result of an electric shock. User must pay attention to these warnings definitely.



This symbol is used to determine the important notes about functions and usage of the device.

CONTENTS

1.PREFACE	Page 6
1.1 GENERAL SPECIFICATIONS	
1.2 ORDERING INFORMATION	
1.3 WARRANTY	
1.4 MAINTENANCE	
2.INSTALLATION	Page 9
2.1 GENERAL DESCRIPTION	
2.2 DIMENSIONS	
2.3 PANEL CUT-OUT	
2.4 ENVIRONMENTAL RATINGS	
2.5 PANEL MOUNTING	
2.6 INSTALLATION FIXING CLAMP	
2.7 REMOVING FROM THE PANEL	
2.8 SELECTION OF OPERATION FUNCTION AND INPUT TYPE WITH DIP SWITCH	
3.ELECTRICAL WIRINGS	Page 15
3.1 TERMINAL LAYOUT AND CONNECTION INSTRUCTION	
3.2 ELECTRICAL WIRING DIAGRAM	
3.3 CONNECTION OF DEVICE SUPPLY VOLTAGE INPUT	
3.4 COUNTING INPUT CONNECTION	
3.4.1 PROXIMITY & SWITCH CONNECTION	
3.4.2 INCREMENTAL ENCODER & SWITCH CONNECTION	
3.4.3 SWITCH CONNECTION	
3.5 GALVANIC ISOLATION TEST VALUES OF EZM-9950 PROGRAMMABLE TIMER&COUNTER AND OUTPUT MODULES	
4.DEFINITIONS AND SPECIFICATIONS OF OUTPUT MODULES	Page 22
4.1 EMO-900 RELAY OUTPUT MODULE	
4.2 EMO-910 SSR DRIVER MODULE	
4.3 EMO-920 DIGITAL (TRANSISTOR) OUTPUT MODULE	
4.4 INSTALLING AND PULLING OUT OUTPUT MODULES	
4.5 TO STICK OUTPUT MODULES' LABELS TO THE DEVICE	
5.CONNECTION TERMINALS OF OUTPUT MODULES AND CONNECTION WIRING	Page 27
5.1 EMO-900 RELAY OUTPUT MODULE CONNECTION	
5.2 EMO-910 SSR DRIVER MODULE CONNECTION	
5.3 EMO-920 DIGITAL (TRANSISTOR) OUTPUT MODULE CONNECTION	
6.CONNECTIONS FOR RS-232 / RS-485 SERIAL COMMUNICATION	Page 29
6.1 CABLE CONNECTION BETWEEN RS-232 TERMINAL OF THE DEVICE AND PC	
6.2 CONNECTION FOR RS-485 SERIAL COMMUNICATION	
6.3 INSTALLING RS-232 / RS-485 SERIAL COMMUNICATION MODULES TO THE DEVICE	
7.DEFINITION OF FRONT PANEL AND ACCESSING TO THE SET PARAMETERS	Page 33
7.1 DEFINITION OF FRONT PANEL	
7.2 POWER ON OBSERVATION OF EZM - 9950 PROGRAMMABLE TIMER & COUNTER AND SOFTWARE REVISION ON THE DISPLAY	

- 7.3 ADJUSTMENT OF SET1 AND SET2 VALUES
- 7.4 RESETTING COUNT VALUE AND OBSERVING TOTAL COUNT VALUE IN COUNTER / "TOTALIZER COUNTER" FUNCTION
- 7.5 COUNTER / "TOTALIZER COUNTER" PARAMETERS
 - 7.5.1 COUNTER / "TOTALIZER COUNTER" APPLICATIONS EXAMPLES
- 7.6 BATCH COUNTER PARAMETERS
 - 7.6.1 BATCH COUNTER APPLICATIONS EXAMPLES
- 7.7 TIME RELAY PARAMETERS
 - 7.7.1 TIMER APPLICATIONS EXAMPLES
- 7.8 FREQUENCYMETER / TACHOMETER PARAMETERS
 - 7.8.1 FREQUENCYMETER / TACHOMETER APPLICATIONS EXAMPLES
- 7.9 CHRONOMETER PARAMETERS
 - 7.9.1 CHRONOMETER APPLICATIONS EXAMPLES
- 7.10 ACCESSING TO THE PROGRAM PARAMETERS

- 8.PROGRAM PARAMETERS.....Page 68**
- 9.FAILURE MESSAGES IN EZM-9950 PROGRAMMABLE TIMER & COUNTER ..Page 101**
- 10.SPECIFICATIONS..... Page 103**
- 11.OTHER INFORMATION.....Page 104**

EU DECLARATION OF CONFORMITY

Manufacturer Company Name : Emko Elektronik A.S.

Manufacturer Company Address: DOSAB, Karanfil Sokak, No:6, 16369 Bursa, Turkiye

The manufacturer hereby declares that the product conforms to the following standards and conditions.

Product Name : Programmable Timer & Counter

Model Number : EZM-9950

Type Number : EZM-9950

Product Category : Electrical equipment for measurement, control and laboratory use

Conforms to the following directives :

2006 / 95 / EC The Low Voltage Directive

2004 / 108 / EC The Electromagnetic Compatibility Directive

has been designed and manufactured to the following specifications:

EN 61000-6-4:2007 EMC Generic Emission Standard for Industrial Environments

EN 61000-6-2:2005 EMC Generic Immunity Standard for Industrial Environments

EN 61010-1:2001 Safety Requirements for electrical equipment for measurement, control and laboratory use

When and Where Issued

16nd October 2009

Bursa-TURKEY

Authorized Signature

Name : Serpil YAKIN

Position : Quality Manager

1.Preface

EZM Series Programmable Timer & Counter can be used in package machines, production and quality control rollers, in cutting and processing machine of glass, plastic, marble, sheet, iron, fabric all measuring and controlling of dimension, count, total count, speed, cycle, productivity, time and can be adapted easily to all mechanical construction and automation system. They can be used in many application with their control outputs, serial communication unit and output modules.

Some application fields which they are used are below:

Application Fields

Glass
Plastic
Marble
Sheet iron
Automotive
Machine production industries

1.1 General Specifications

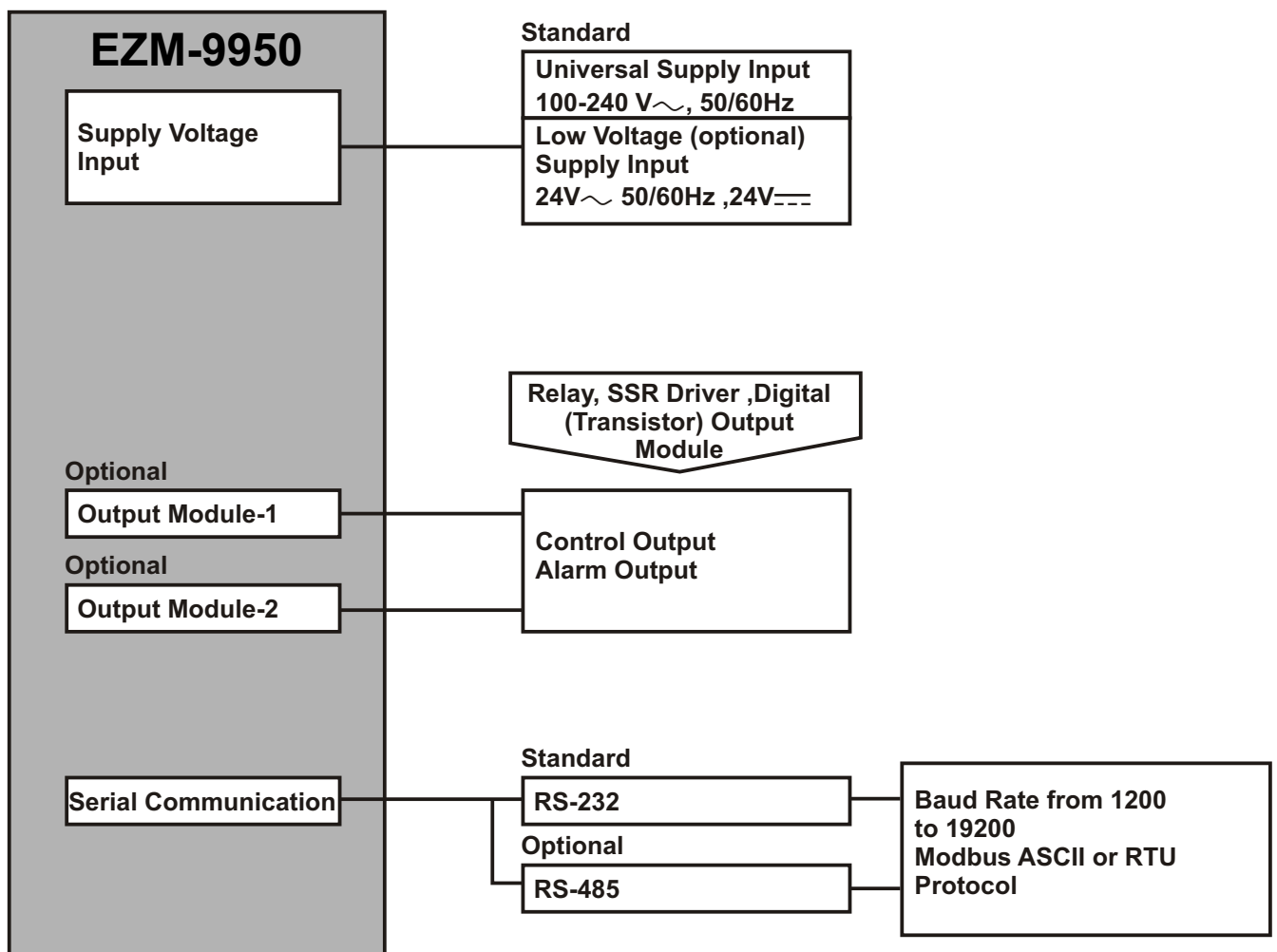

1.2 Ordering Information

EZM-9950 (96x96 1/4 DIN)	A	B	C	D	E	/	FG	HI	/	U	V	W	Z
		00		0	/			/			0	0	

A	Supply Voltage
1	100-240V \sim (-15%;+10%) 50/60Hz
2	24 V \sim (-15%;+10%) 50/60Hz 24V --- (-15%;+10%)
9	Customer (Maximum 240V \sim (-15%;+10%))50/60Hz

D	Serial Communication	Product Code
0	None	-
1	RS-232	EMC-900
2	RS-485	EMC-910

FG	Module-1	Product Code
00	None	-
01	Relay Output Module(5A@250V \sim Resistive Load)	EMO-900
02	SSR Driver Output Module	EMO-910
03	Digital(Transistor) Output Module	EMO-920

HI	Module-2	Product Code
00	None	-
01	Relay Output Module(5A@250V \sim Resistive Load)	EMO-900
02	SSR Driver Output Module	EMO-910
03	Digital(Transistor) Output Module	EMO-920

U	Function of Device
0	Counter / "Totalizer Counter"
1	Batch Counter
2	Timer
3	Frequencymeter and Tachometer
4	Chronometer

V	Input Type
0	NPN
1	PNP

All order information of EZM-9950 Programmable Timer&Counter are given on the table at left. User may form appropriate device configuration from information and codes that at the table and convert it to the ordering codes.

Firstly, supply voltage then output modules and other specifications must be determined. Please fill the order code blanks according to your needs.

Please contact us, if your needs are out of the standards.



\sim Symbol means Vac,

--- Symbol means Vdc

$\sim\text{---}$ Symbol means Vac and Vdc

1.3 Warranty

EMKO Elektronik warrants that the equipment delivered is free from defects in material and workmanship. This warranty is provided for a period of two years. The warranty period starts from the delivery date. This warranty is in force if duty and responsibilities which are determined in warranty document and instruction manual performs by the customer completely.

1.4 Maintenance

Repairs should only be performed by trained and specialized personnel. Cut power to the device before accessing internal parts.

Do not clean the case with hydrocarbon-based solvents (Petrol, Trichlorethylene etc.). Use of these solvents can reduce the mechanical reliability of the device. Use a cloth dampened in ethyl alcohol or water to clean the external plastic case.

2. Installation



Before beginning installation of this product, please read the instruction manual and warnings below carefully.

In package ,

- One piece unit
- Two pieces mounting clamps
- One piece instruction manual

A visual inspection of this product for possible damage occurred during shipment is recommended before installation. It is your responsibility to ensure that qualified mechanical and electrical technicians install this product.

If there is danger of serious accident resulting from a failure or defect in this unit, power off the system and separate the electrical connection of the device from the system.

The unit is normally supplied without a power switch or a fuse. Use power switch and fuse as required.

Be sure to use the rated power supply voltage to protect the unit against damage and to prevent failure.

Keep the power off until all of the wiring is completed so that electric shock and trouble with the unit can be prevented.

Never attempt to disassemble, modify or repair this unit. Tampering with the unit may results in malfunction, electric shock or fire.

Do not use the unit in combustible or explosive gaseous atmospheres.

During the equipment is putted in hole on the metal panel while mechanical installation some metal burrs can cause injury on hands, you must be careful.

Montage of the product on a system must be done with it's fixing clamps. Do not do the montage of the device with inappropriate fixing clamp. Be sure that device will not fall while doing the montage.

It is your responsibility if this equipment is used in a manner not specified in this instruction manual.

2.1 General Description

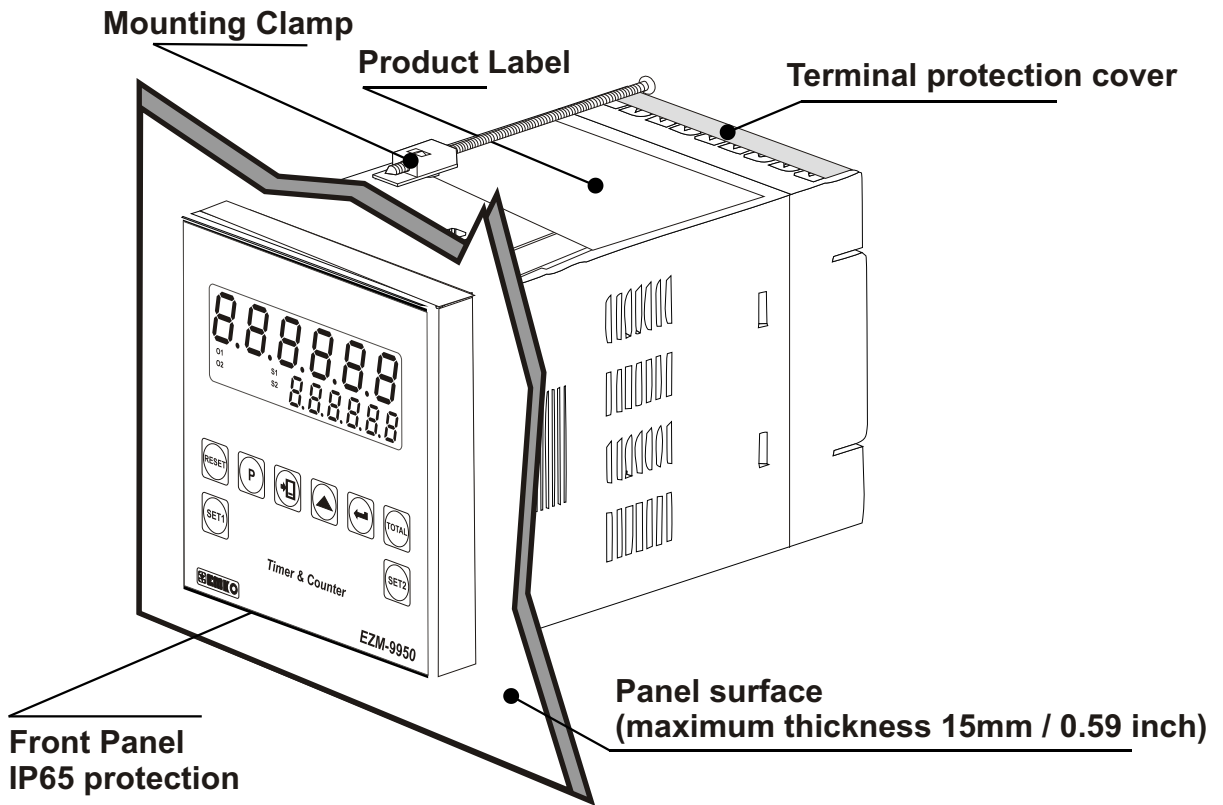

2.2 Dimensions

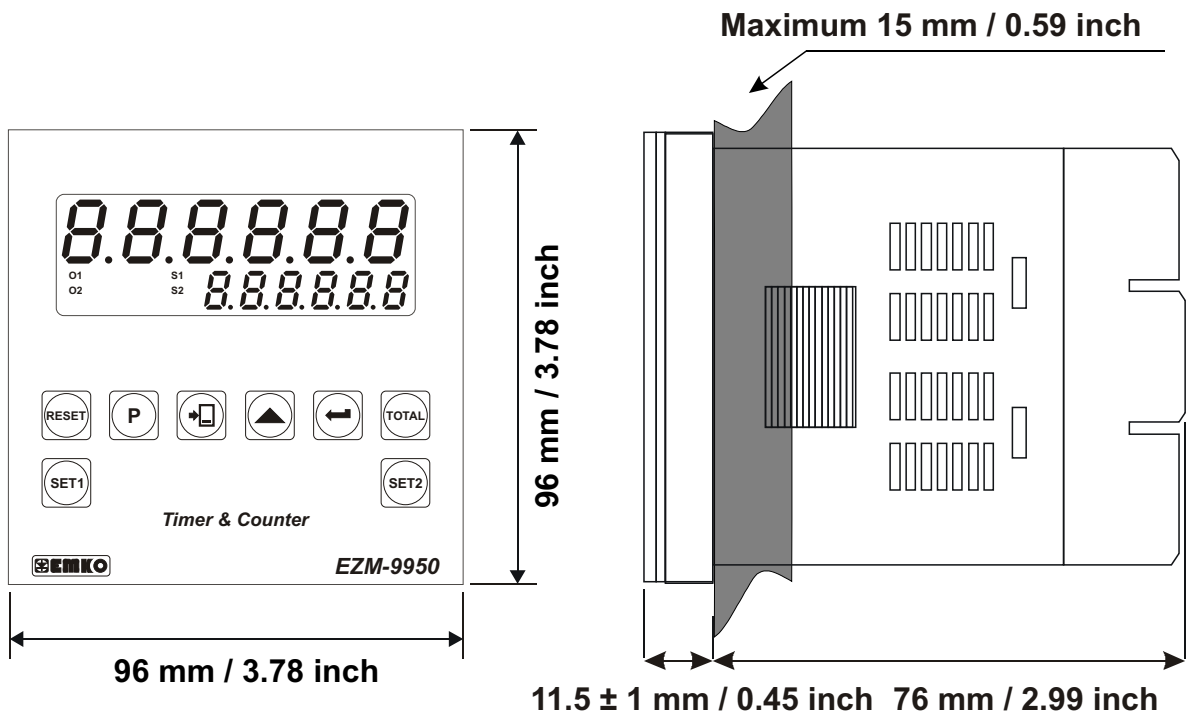

2.3 Panel Cut-Out

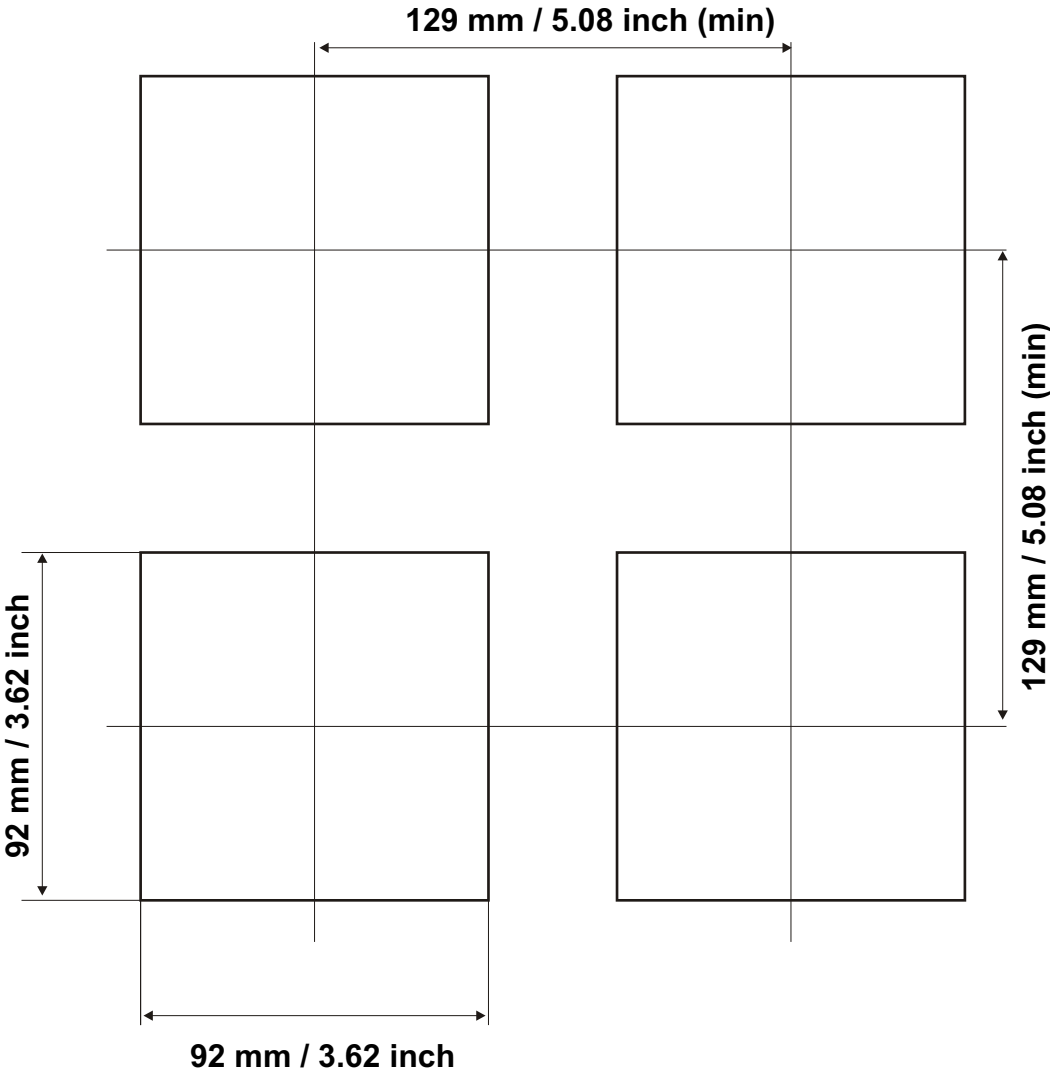

2.4 Environmental Ratings

Operating Conditions



Operating Temperature : 0 to 50 °C



Max. Operating Humidity : 90% Rh (non-condensing)



Altitude : Up to 2000m.



Forbidden Conditions:

Corrosive atmosphere

Explosive atmosphere

Home applications (The unit is only for industrial applications)

2.5 Panel Mounting

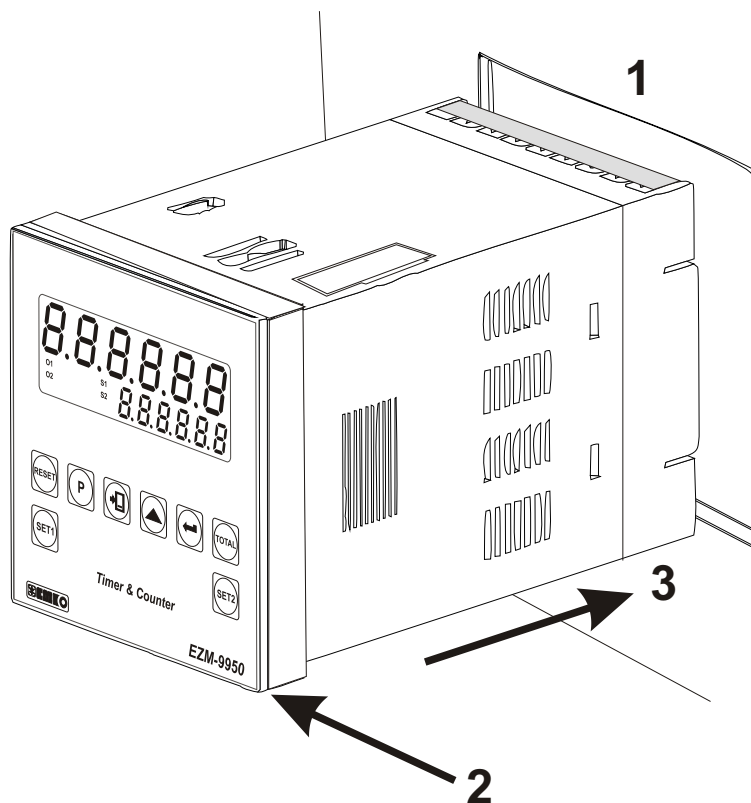

1-Before mounting the device in your panel, make sure that the cut-out is the right size.

2-Check front panel gasket position

3-Insert the device through the cut-out. If the mounting clamps are on the unit, put out them before inserting the unit to the panel.



During installation into a metal panel, care should be taken to avoid injury from metal burrs which might be present. The equipment can loosen from vibration and become dislodged if installation parts are not properly tightened. These precautions for the safety of the person who does the panel mounting.

2.6 Installation Fixing Clamp

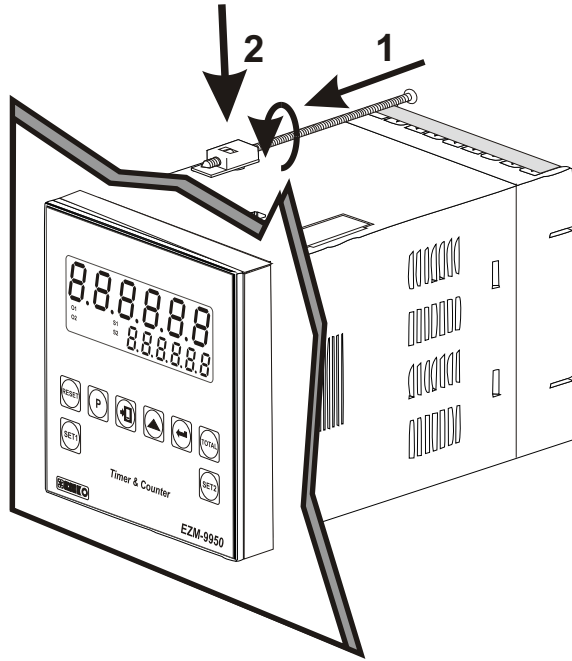

The unit is designed for panel mounting.

1-Insert the unit in the panel cut-out from the front side.

2- Insert the mounting clamps to the holes that located top and bottom sides of device and screw up the fixing screws until the unit completely immobile within the panel



Montage of the unit to a system must be done with it's own fixing clamps. Do not do the montage of the device with inappropriate fixing clamps. Be sure that device will not fall while doing the montage.

2.7 Removing from the Panel



Before starting to remove the unit from panel, power off the unit and the related system.

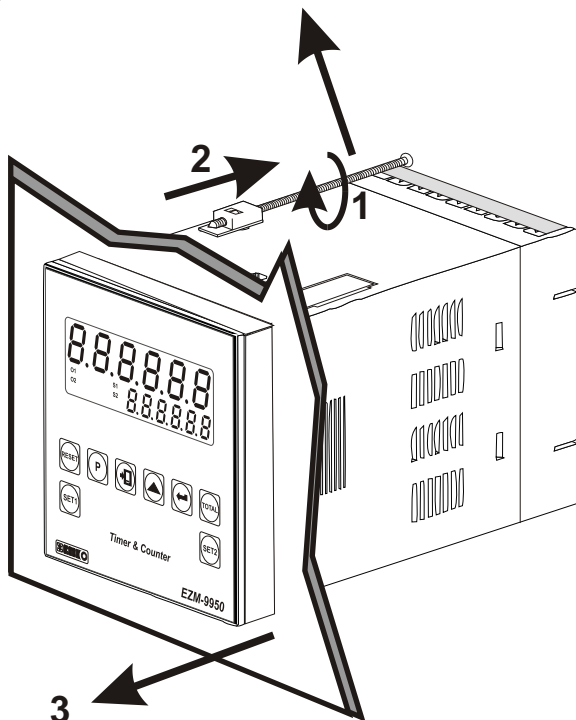

1-Loosen the screws.

2-Pull mounting clamps from top and bottom fixing sockets.

3-Pull the unit through the front side of the panel

2.8 Selection of Operation Function and Input Type with DIP Switch



Operation function and input type (NPN / PNP) can be changed by DIP switch on the device.

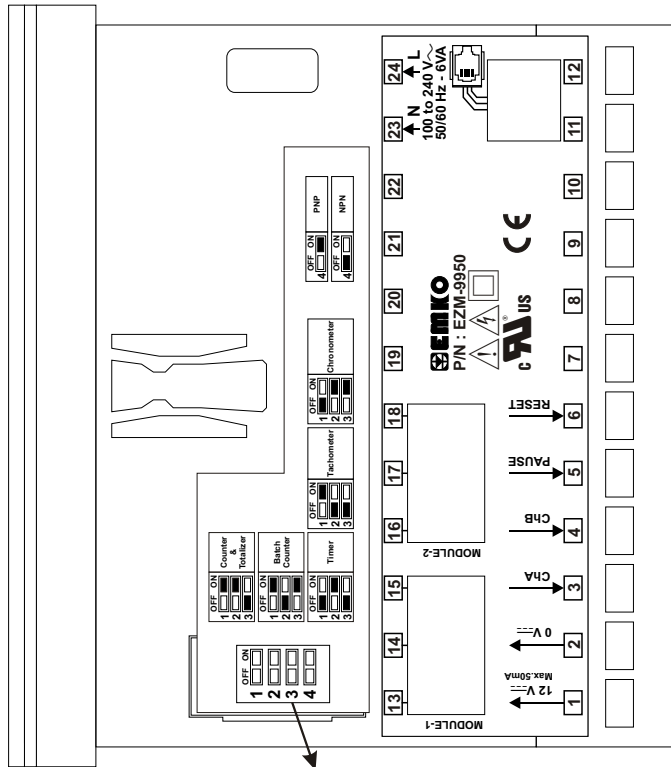

DIP Switch is under cover and cover is on top side of the device

Function Selection

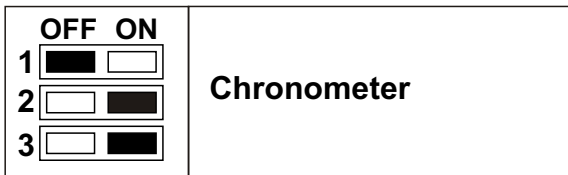
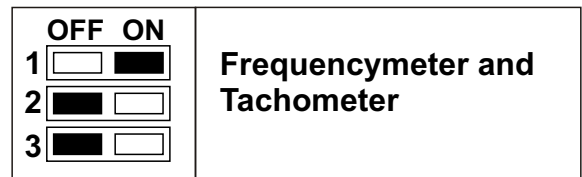
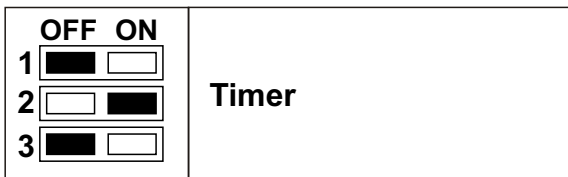

Input Type Selection



3. Electrical Wirings



You must ensure that the device is correctly configured for your application. Incorrect configuration could result in damage to the process being controlled, and/or personal injury. It is your responsibility, as the installer, to ensure that the configuration is correct.

Parameters of the device has factory default values. These parameters must be set according to the system's needs.



Only qualified personnel and technicians should work on this equipment. This equipment contains internal circuits with voltage dangerous to human life. There is severe danger for human life in the case of unauthorized intervention.



Be sure to use the rated power supply voltage to protect the unit against damage and to prevent failure.



Keep the power off until all of the wiring is completed so that electric shock and trouble with the unit can be prevented.

3.1 Terminal Layout and Connection Instructions

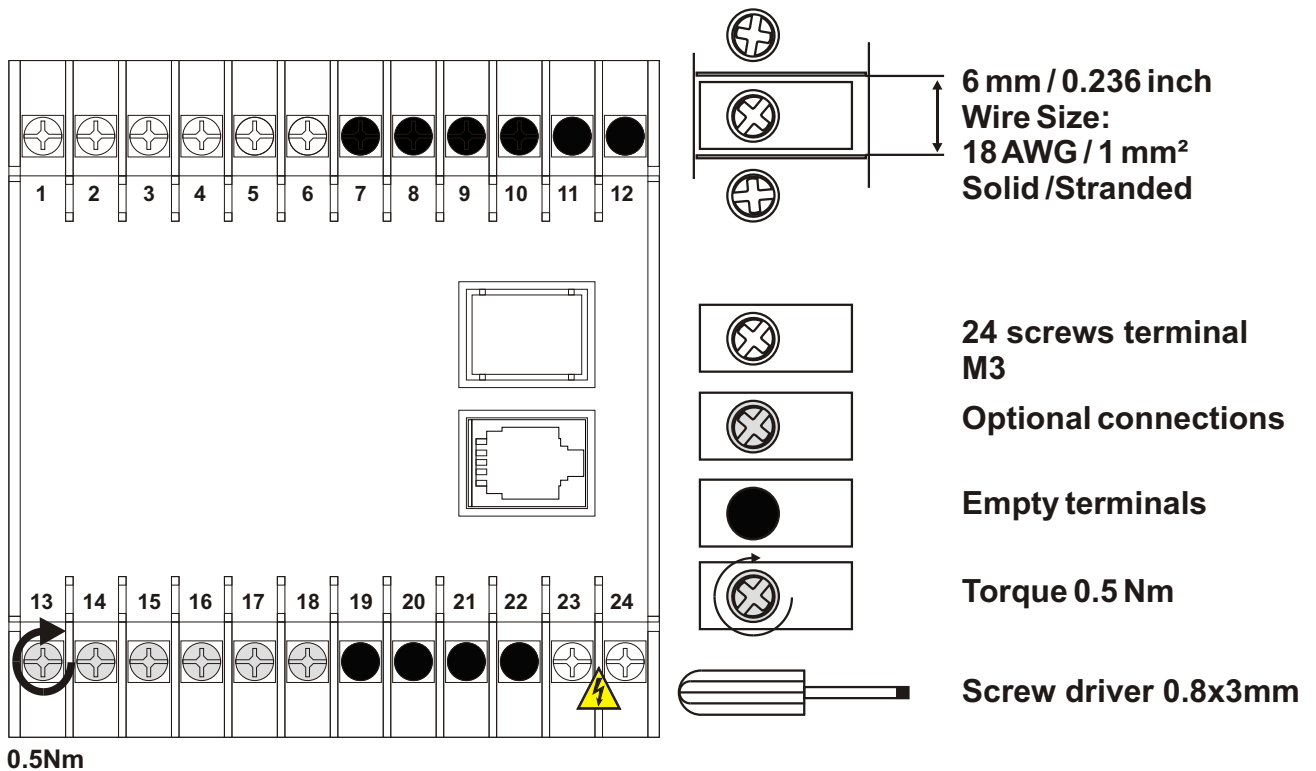

3.2 Electrical Wiring Diagram



Electrical wiring of the device must be the same as 'Electrical Wiring Diagram' below to prevent damage to the process being controlled and personnel injury.

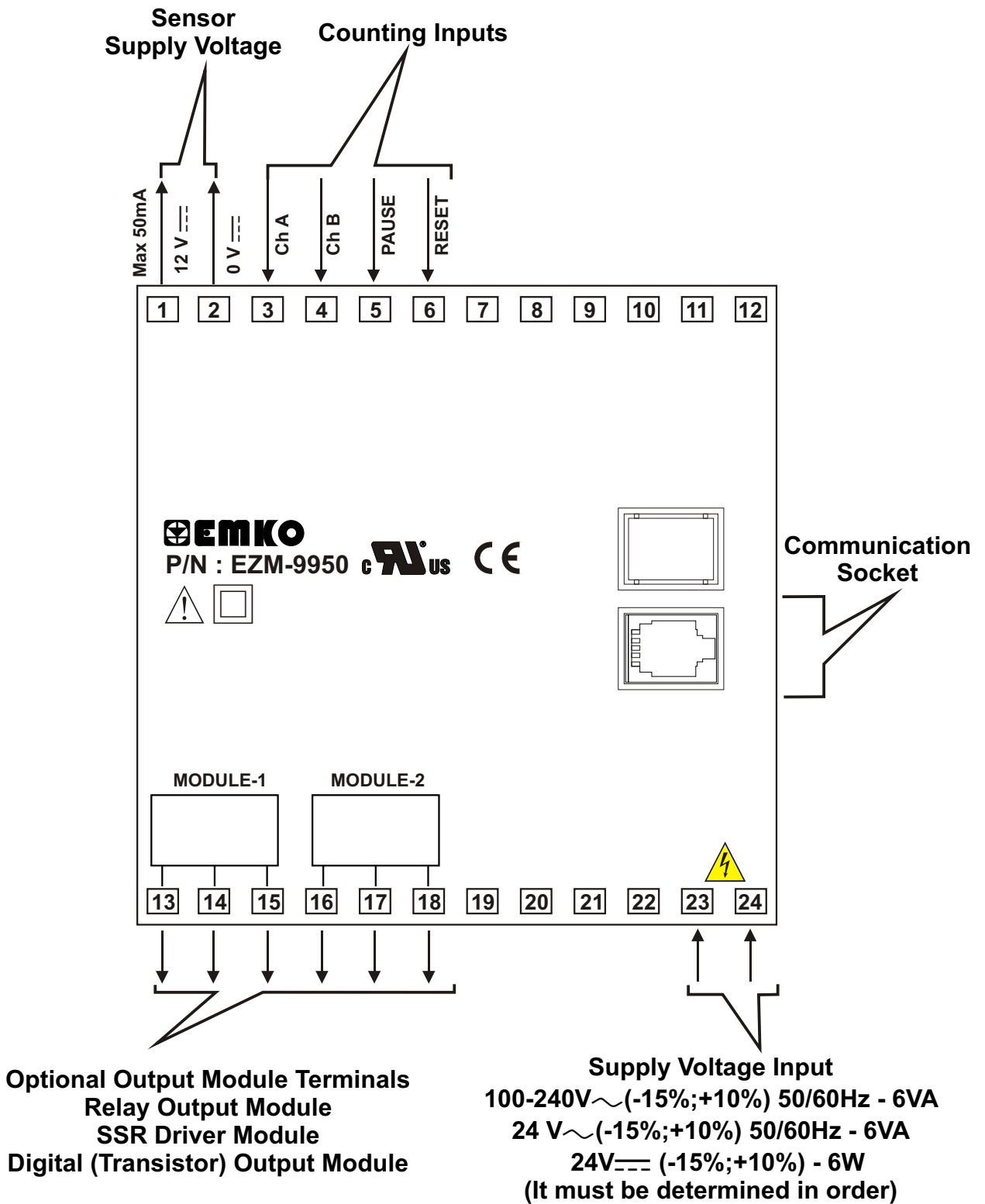

3.3 Connection of Device Supply Voltage Input

Connection of Universal Supply Voltage Input

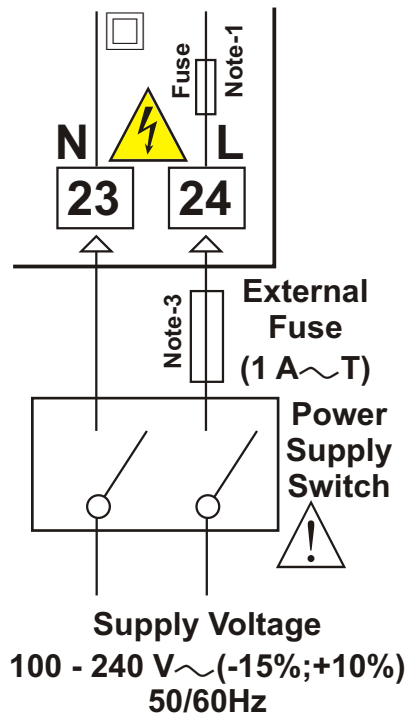

Connection of Low Voltage 24 V \sim Supply Voltage Input

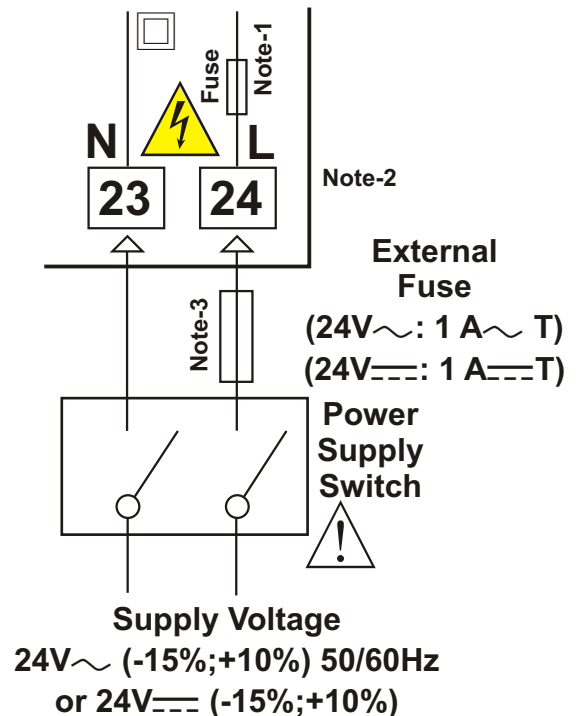

Note-1 :

There is internal 33R fusible flameproof resistor in 100-240 V \sim 50/60Hz

There is internal 4R7 fusible flameproof resistor in 24V \sim 50/60Hz and 24V $==$

Note-2 :“L” is “+”, “N” is “-” for 24V $==$ supply voltage

Note-3 : External fuse is recommended.



Make sure that the power supply voltage is the same indicated on the instrument.

Switch on the power supply only after that all the electrical connections have been completed.

Supply voltage range must be determined in order. While installing the unit, supply voltage range must be controlled and appropriate supply voltage must be applied to the unit. Controlling prevents damages in unit and system and possible accidents as a result of incorrect supply voltage.



There is no power supply switch on the device. So a power supply switch must be added to the supply voltage input. In accordance with the safety regulations, the power supply switch shall bring the identification of the relevant instrument. Power supply switch shall be easily accessible by the user.

Power switch must be two poled for separating phase and neutral. On/Off condition of power switch is very important in electrical connection. On/Off condition of power switch must be signed for preventing the wrong connection.

If an external fuse is used, it must be on phase connection in \sim supply input.

If an external fuse is used, it must be on (+) line connection in $==$ supply input.



The instrument is protected with an internal fuse (Please refer to Note1 for information). In case of failure it is suggested to return the instrument to the manufacturer for repair.

3.4 Counting Input Connection

3.4.1 Proximity & Switch Connection

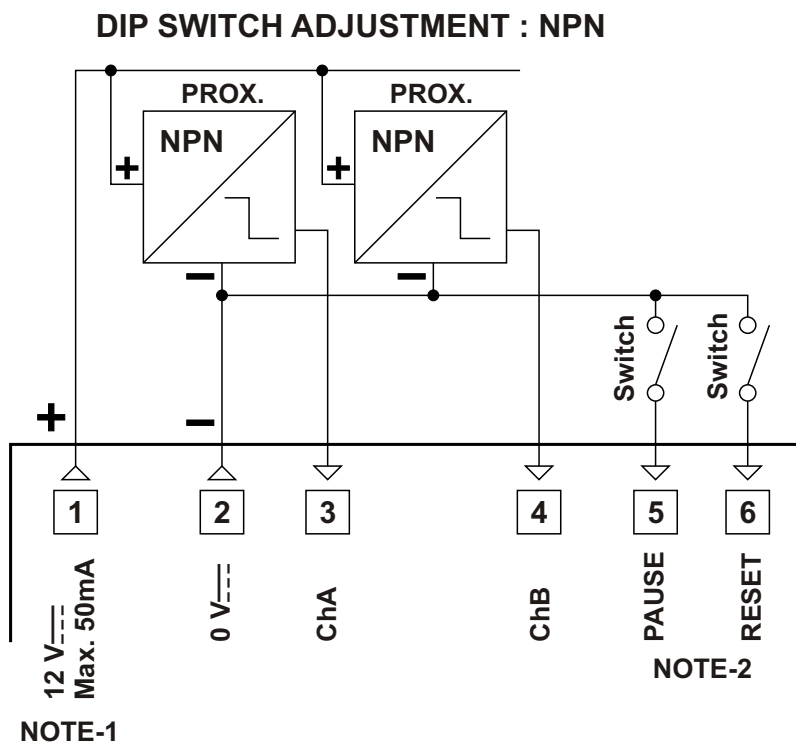
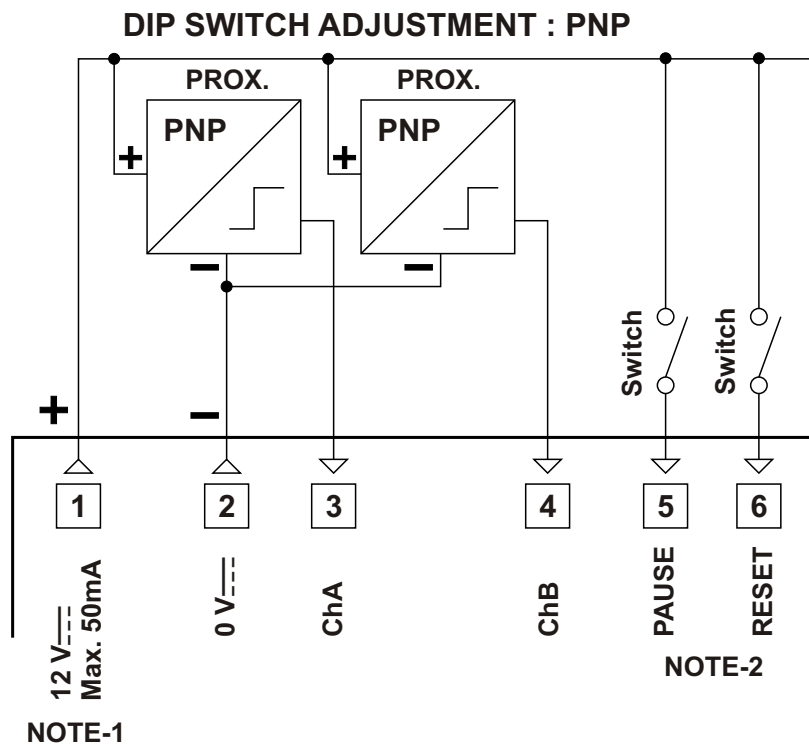

NOTE-1 : Auxiliary power supply for external transmitter
12V \pm 10%, 50 mA maximum with short circuit protection

NOTE-2 : Reset and Pause inputs have protection time against electrical contact debounce. Protection time can be set with `Pr0-04` parameter. (2-250 msec.)

3.4.2 Incremental Encoder & Switch Connection

DIP SWITCH ADJUSTMENT : PNP

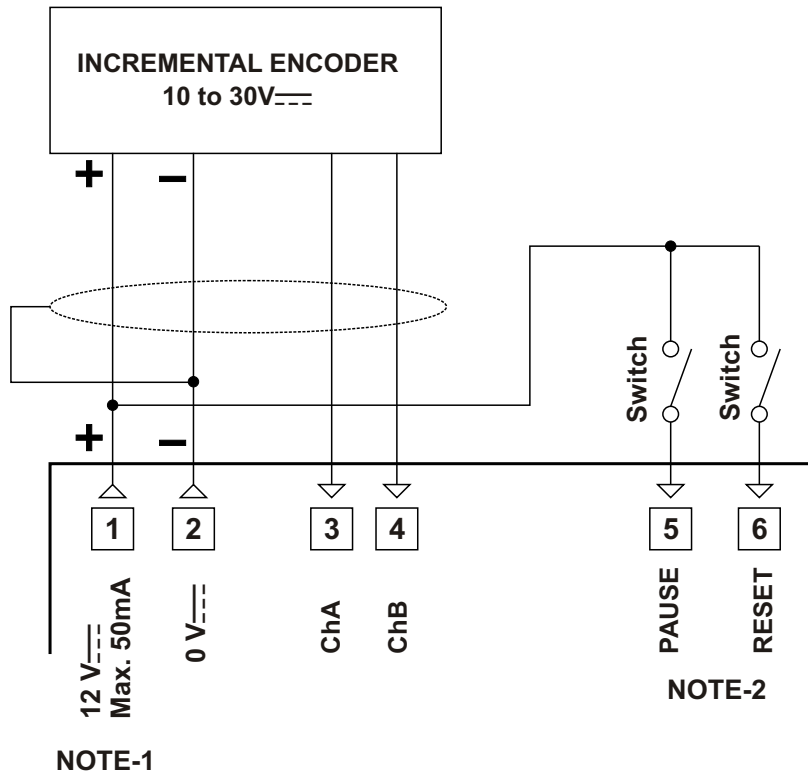

DIP SWITCH ADJUSTMENT : NPN

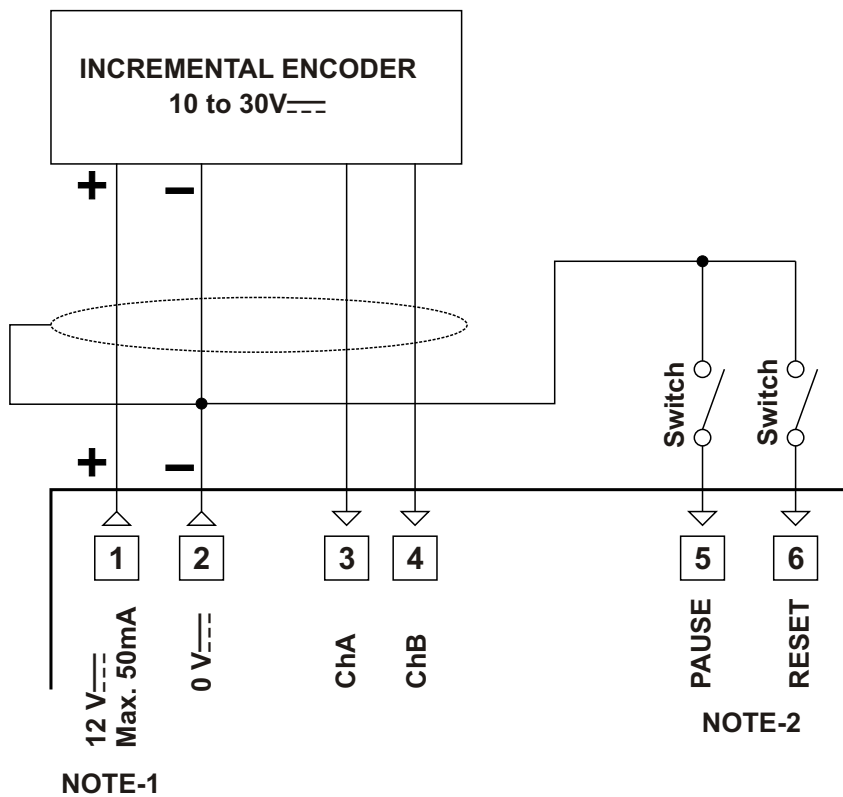

NOTE-1 : Auxiliary power supply for external transmitter
12V_{DC} ± 10%, 50 mA maximum short circuit protection

NOTE-2 : Reset and Pause inputs have protection time against electrical contact bounce. Protection time can be set with `Pro-04` parameter. (2-250 msec.)

3.4.3 Switch Connection

DIP SWITCH ADJUSTMENT : PNP

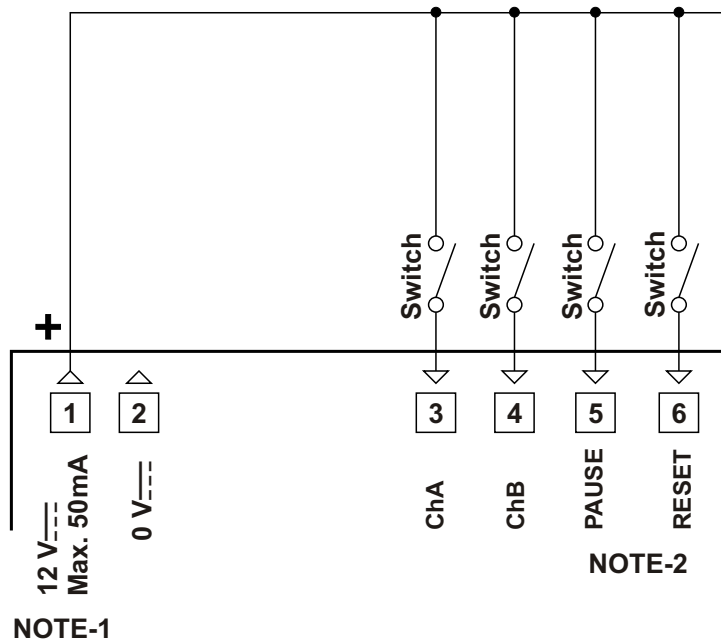

DIP SWITCH ADJUSTMENT : NPN

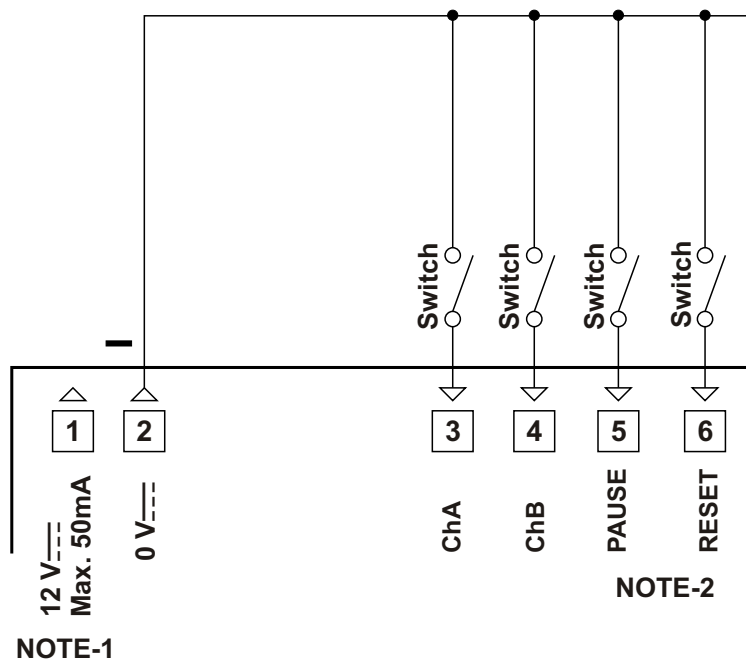

NOTE-1 : Auxiliary power supply for external transmitter
 $12V \pm 10\%$, 50 mA maximum short circuit protection

NOTE-2 : Reset and Pause inputs have protection time against electrical contact bounce. Protection time can be set with `Pro-04` parameter. (2-250 msec.)

3.5 Galvanic Isolation Test Results of EZM-9950 Programmable Timer & Counter and Output Modules

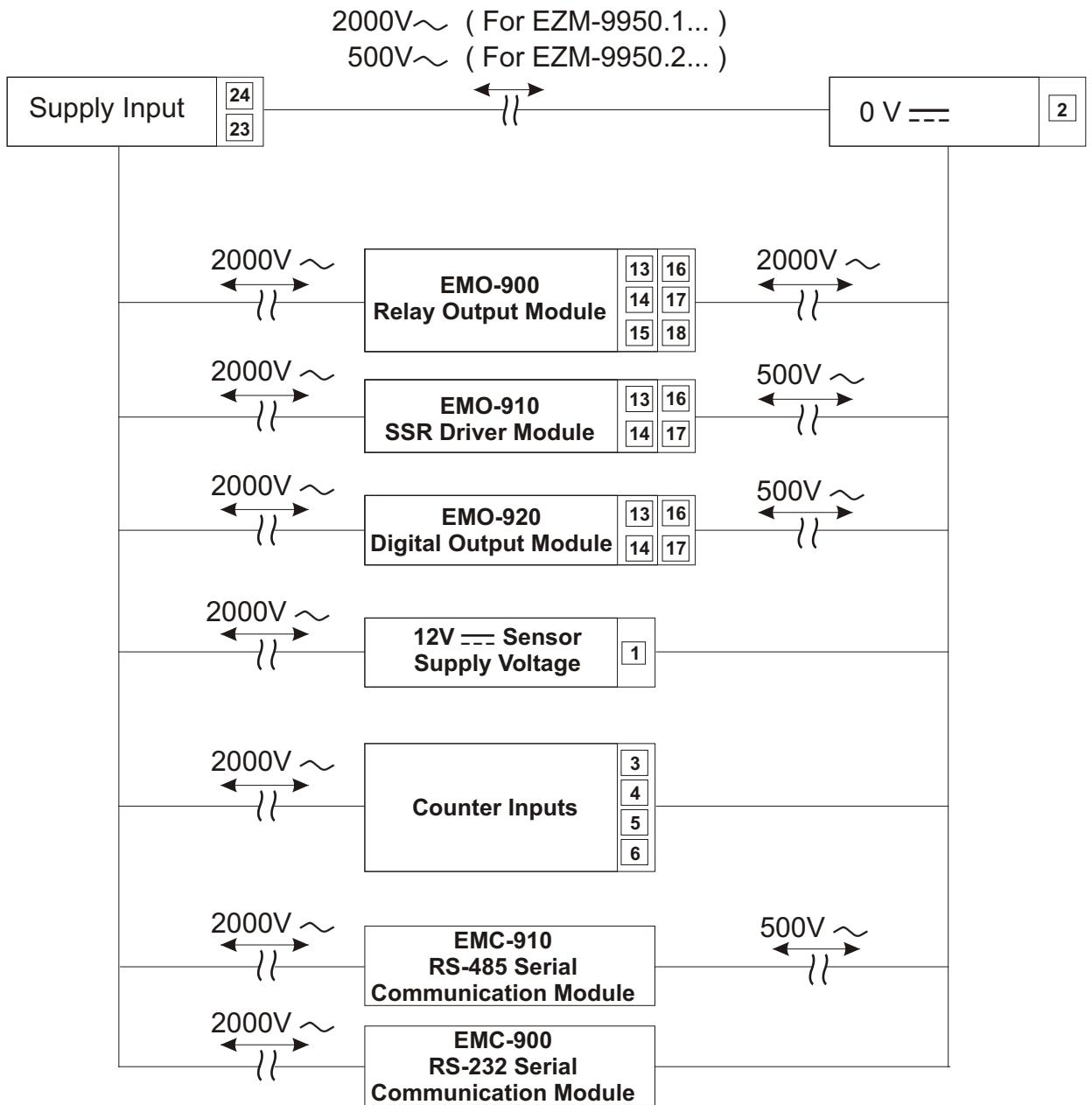

4. Definitions and Specifications of Output Modules

EZM-9950 programmable Timer & Counter is a modular product which is designed to operate with additional output units which user may need.

Two output modules can be plugged in the equipment by the user. User may configure the product for different applications according to the system requirements with the output modules which are described in this section.

Dimensions of Output Modules

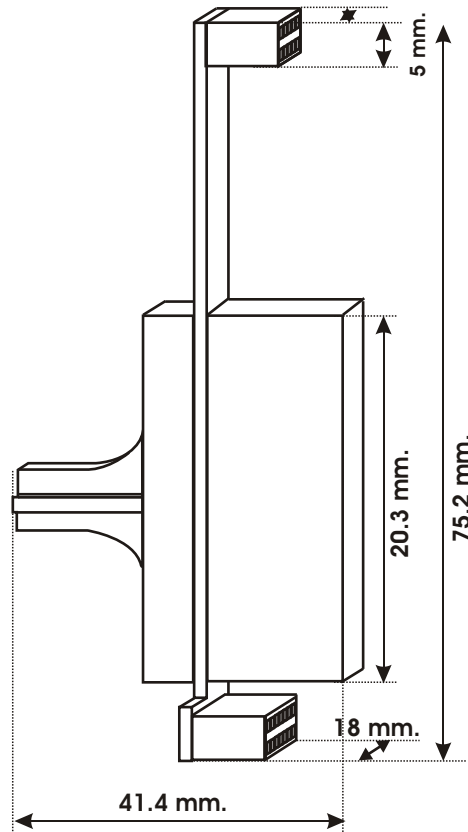

4.1 EMO-900 Relay Output Module

EMO-900 Relay output module can be plugged in Module-1 or Module-2 socket to be used in applications that relay output is necessary

Specifications of EMO-900 Relay Output Module

Output : 5A @ 250V~, Single Open / Close Contact
Dimensions : 18x75.2x41.4mm
Electrical Life : 100.000 operation (Full Load)

Applications of EMO-900 Relay Output Module

It can be used for programmable different alarm functions as control or alarm output.

4.2 EMO-910 SSR Driver Module

EMO-910 SSR Driver Module can be plugged in Module-1 or Module-2 socket to be used in applications that SSR driver output is necessary

Specification of EMO-910 SSR Driver Module

Output : Maximum 26 mA, 22V \pm 10%, isolated

Dimensions : 18x75.2x41.4mm

Applications of EMO-910 SSR Driver Module

It can be used for programmable different alarm functions as control or alarm output.

Note 1: SSR Driver Module must be preferred instead of relay output module in applications with short output period because of limited life of their relay contact (number of open/close events).

4.3 EMO-920 Digital (Transistor) Output Module

EMO-920 Digital (Transistor) Output Module can be plugged in Module-1 or Module-2 socket to be used in applications that digital output is necessary

Specifications of EMO-920 Digital (Transistor) Output Module

Output : Maximum 40 mA, 15-18V \pm 10%, isolated

Dimensions : 18x75.2x41.4mm

Applications of EMO-920 Digital (Transistor) Output Module

It can be used for programmable different alarm functions as control or alarm output.

4.4 Installing and Pulling Out Output Modules



First, detach all cable connections from the device and uninstall it from the panel.

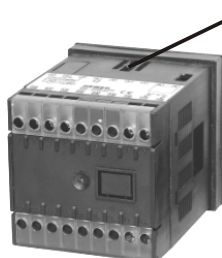

Suppress to the lock pins where top and bottom of the device

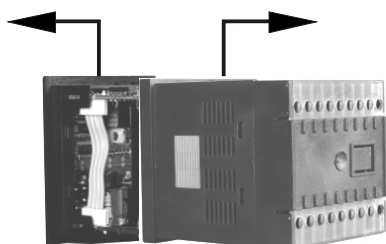

Pull the cover case with your other hand from front panel to rear side.

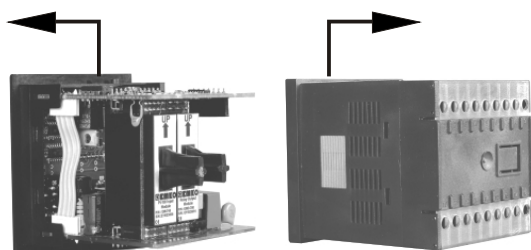

Pull out the cover case from the device

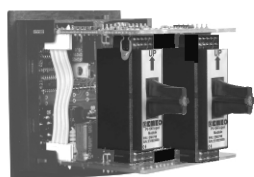

Slide output modules into socket.
Pull out the module from it's socket, instead of this module install the new one or other module user wants to use.

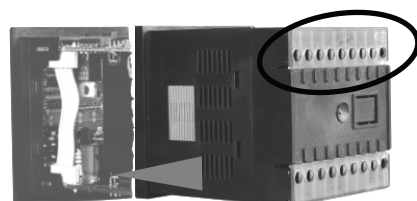

Replace the cover case by taking care of the terminal numbers should be at right position.



After adding or changing modules to the unit, these changes must be taken into consideration while mounting of the unit to the system. If mounting is incorrect, it can cause accidents to harm system, operator or person who does the mounting. Responsibility of these kind of harmful events belongs to the user.

4.5 To Stick Output Modules' Labels to the Equipment

Every module which is plugged in Module-1 or Module-2 socket has labels' for showing the relation between connection terminal and the device. These labels are attached to empty attachment places which are separated for Module-1 and Module-2 on the device. Labels for all modules and attachment places are shown below.

Label which is plugged in Module-2 socket, describes module termination connection is attached to this area.

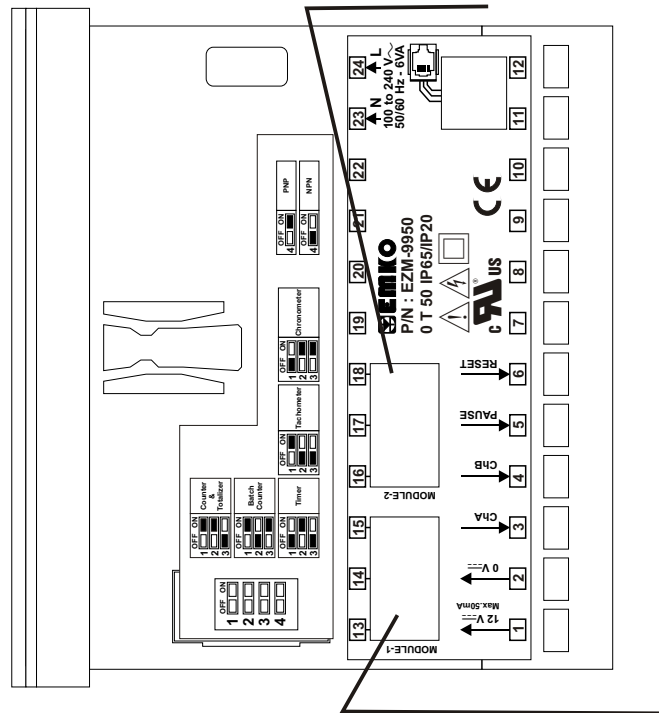

Label which is plugged in Module-1 socket, describes module termination connection is attached to this area.

LABELS FOR OUTPUT MODULES

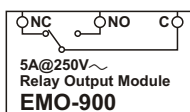

Label for EMO-900 Relay Output Module

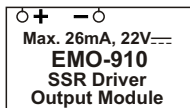

Label for EMO-910 SSR Driver Output Module



Label for EMO-920 Digital (Transistor) Output Module

Example : If user installs EMO-900 Relay Output Module to Module-1 socket, EMO-910 SSR Driver Output Module to Module-2 socket and attach the appropriate labels on the device view will be like below :

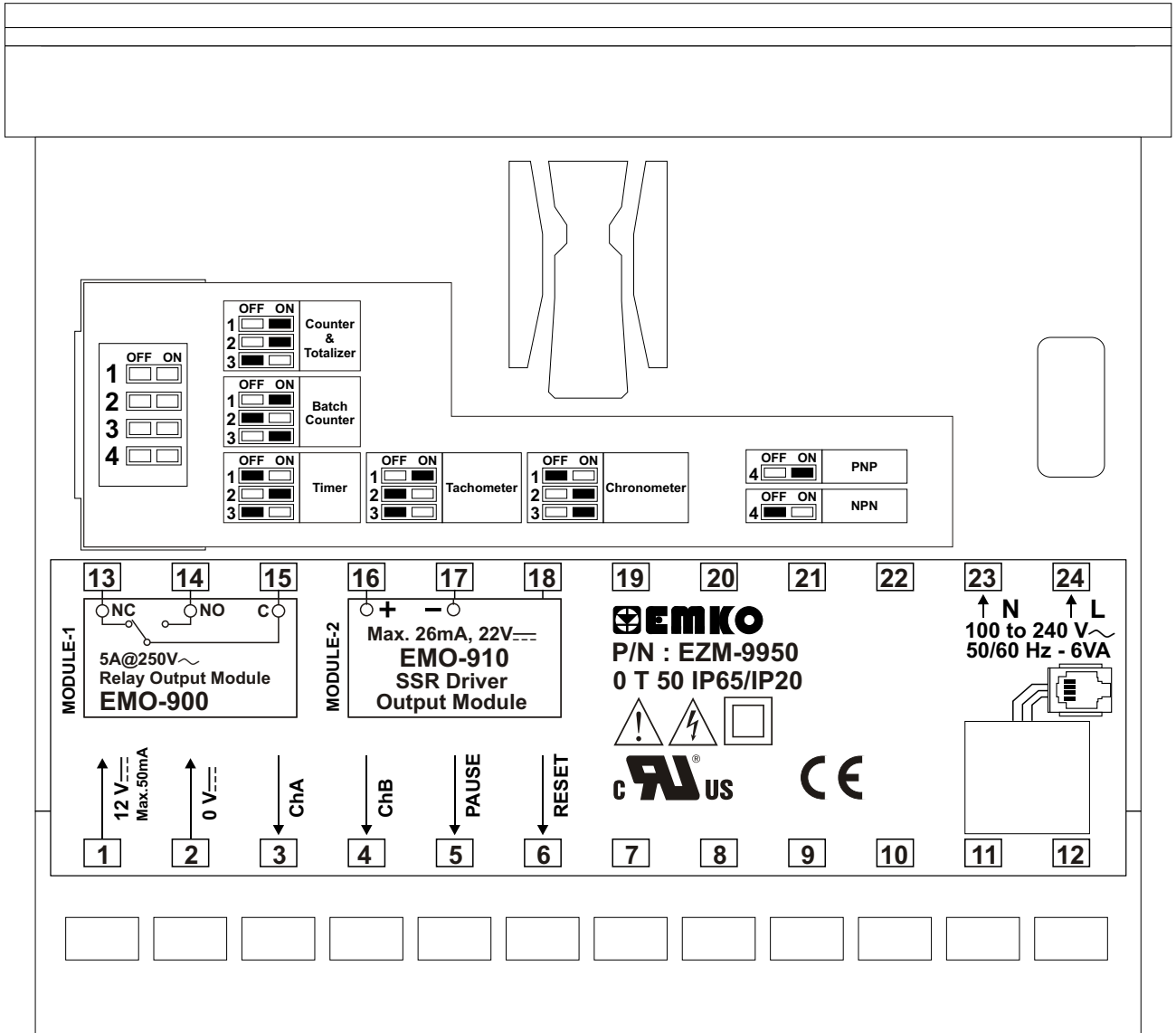

5.Connection Terminals of Output Modules and Connection Wirings

Module-1 / Module-2 Optional Output Modules

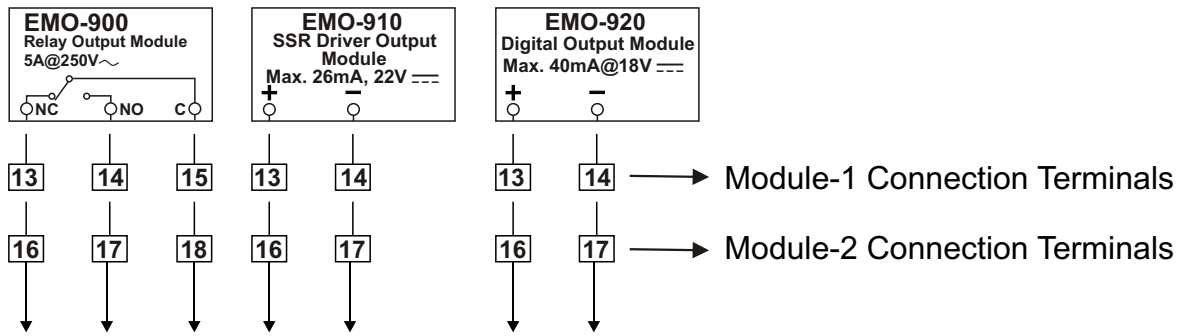

5.1 EMO-900 Relay Output Module Connection

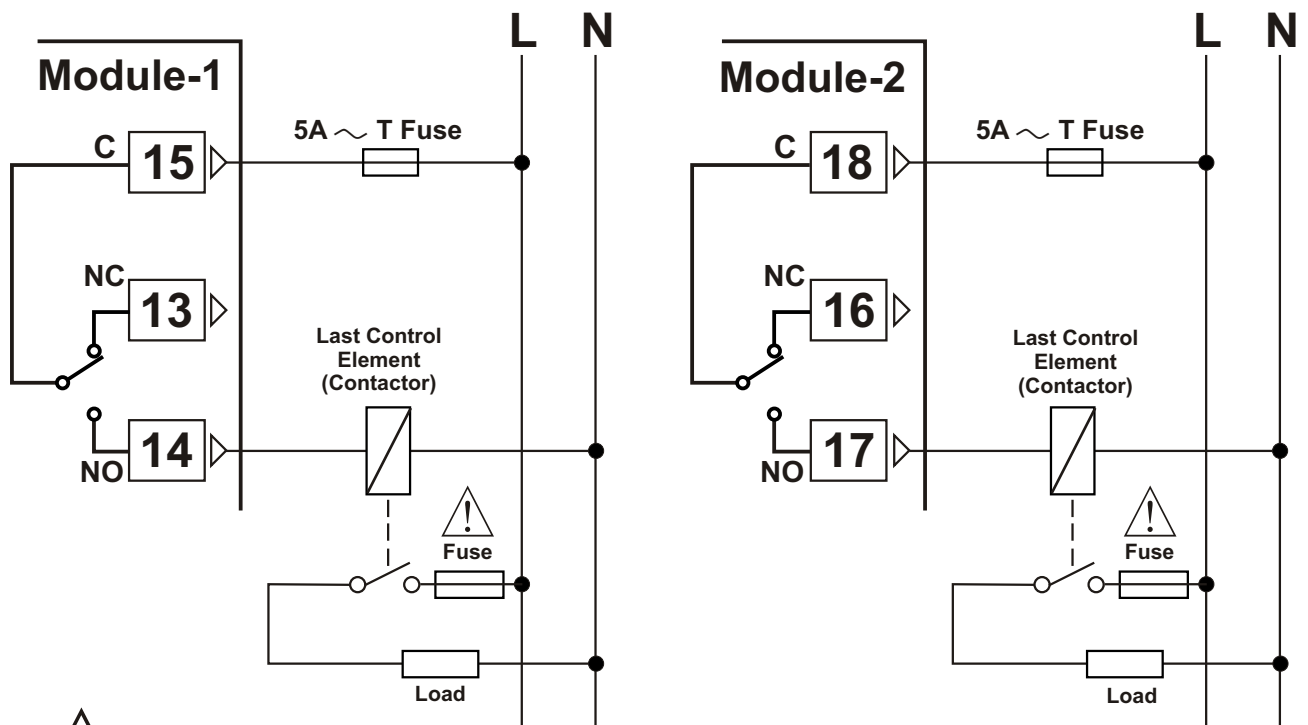

Fuses must be selected according to the applications.

5.2 EMO-910 SSR Driver Module Connection

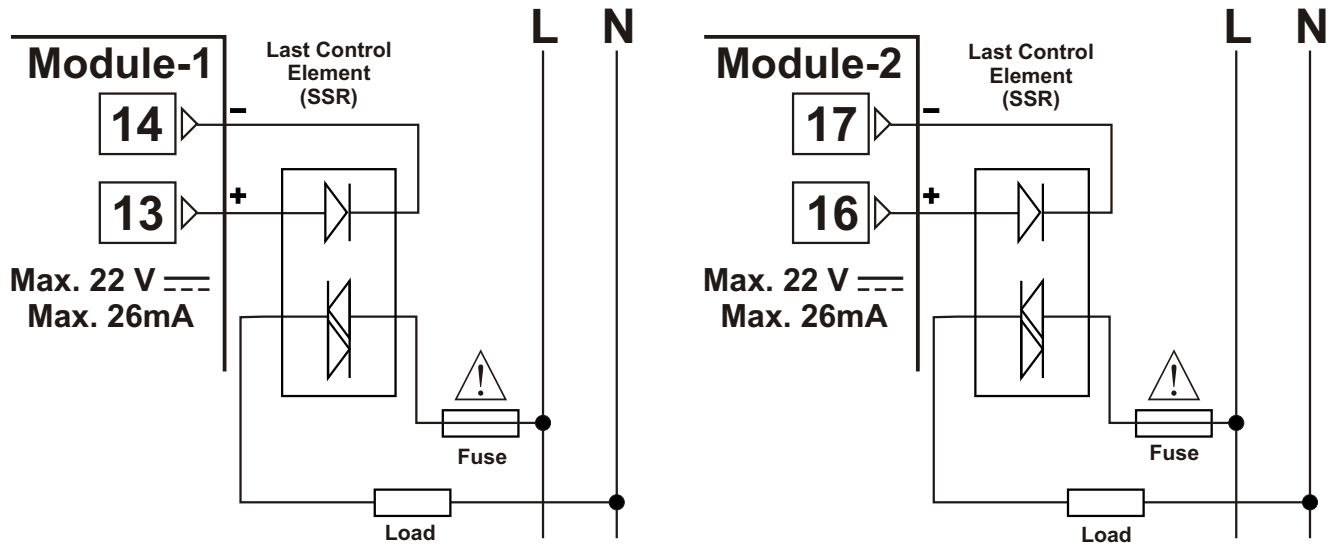

Fuses must be selected according to the applications.

5.3 EMO-920 Digital (Transistor) Output Module Connection

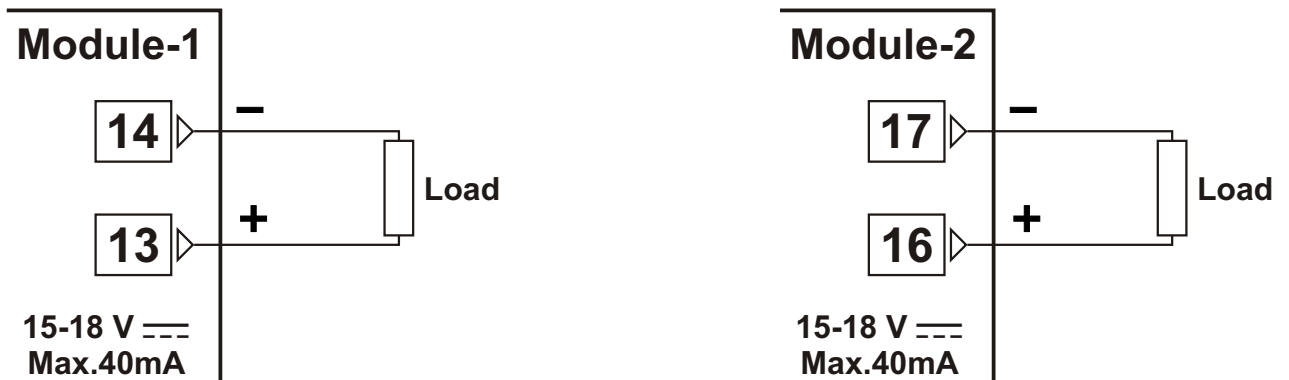

6.Connection for RS-232 / RS-485 Serial Communication

RS-232 Terminal Definitions

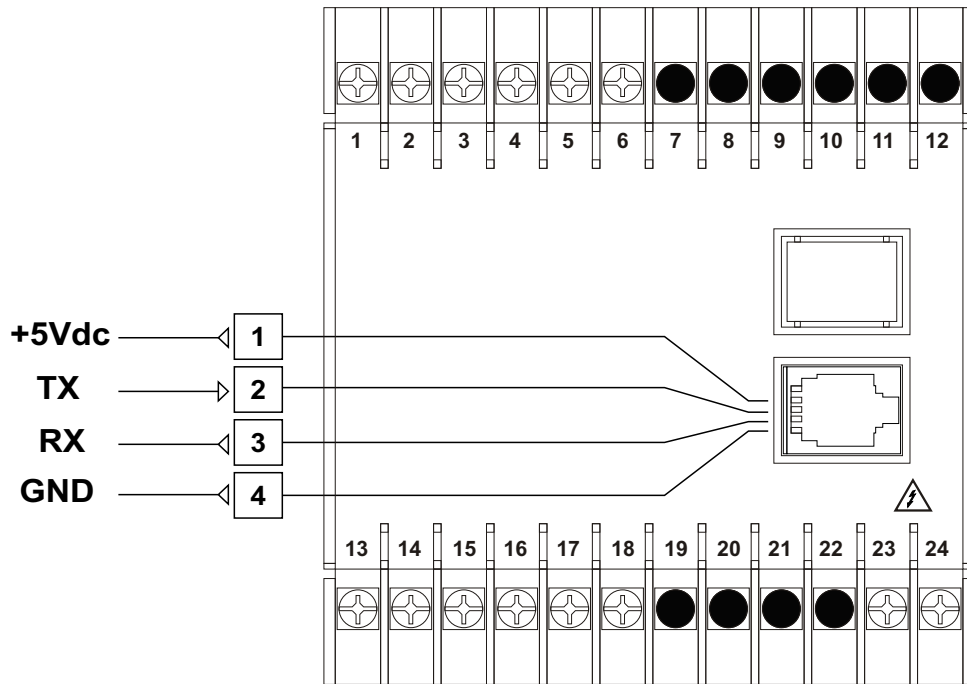

RS-485 Terminal Definitions

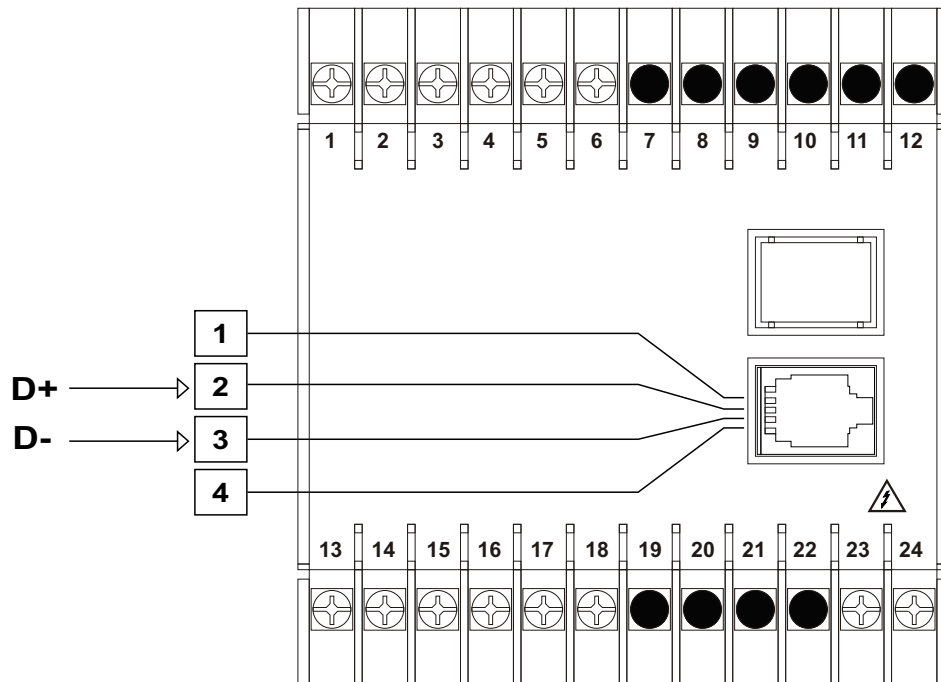

6.1 Cable Connection Between RS-232 Terminal of the Device and the PC

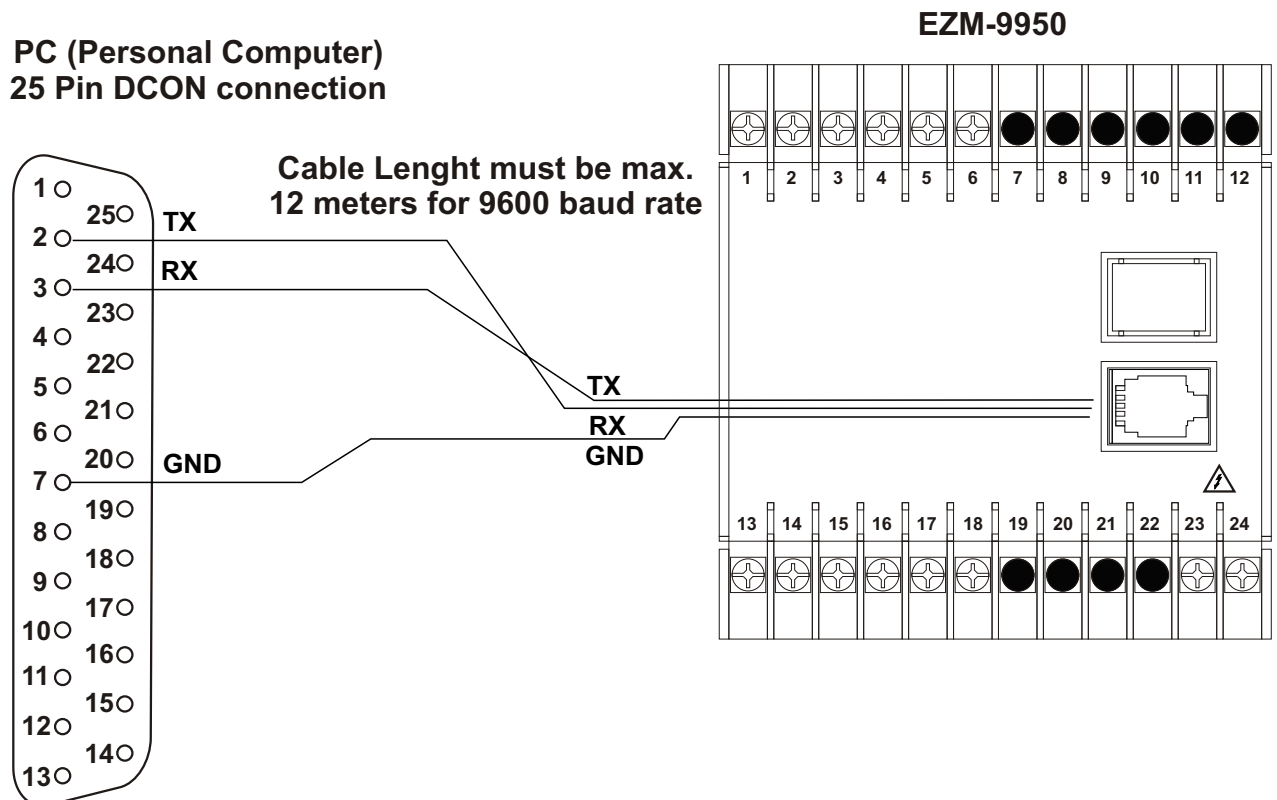
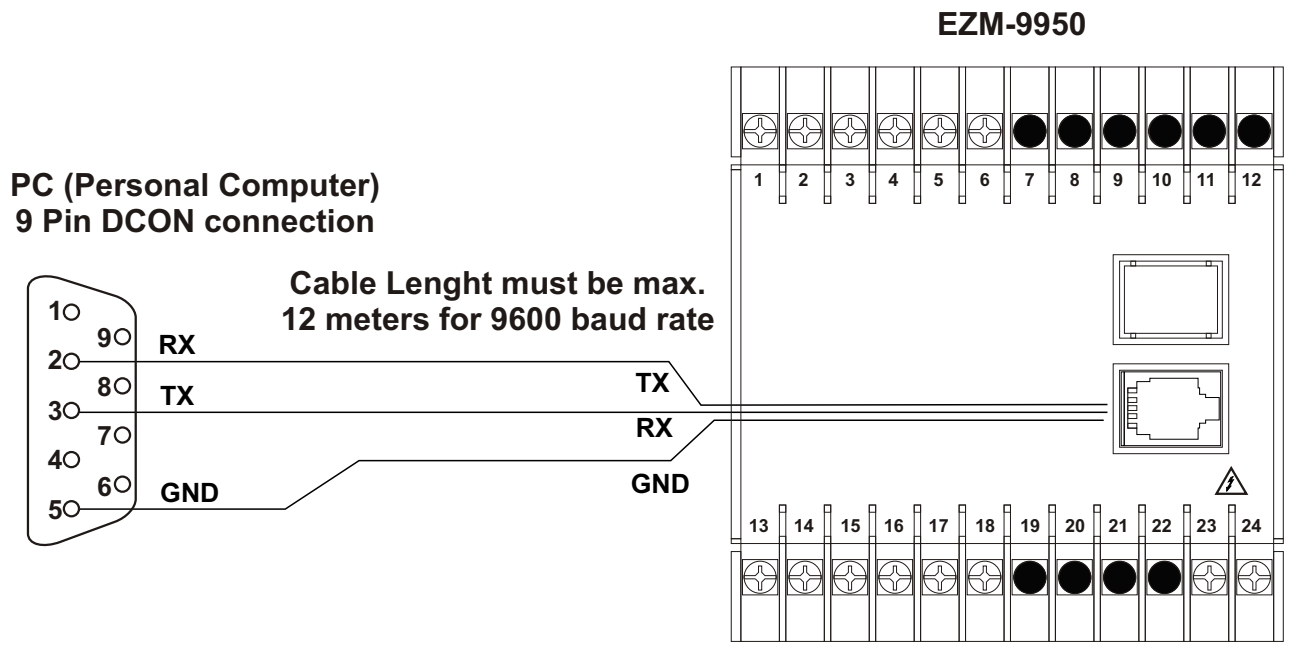

6.2 Connection for RS-485 Serial Communication

PC(Personal Computer)

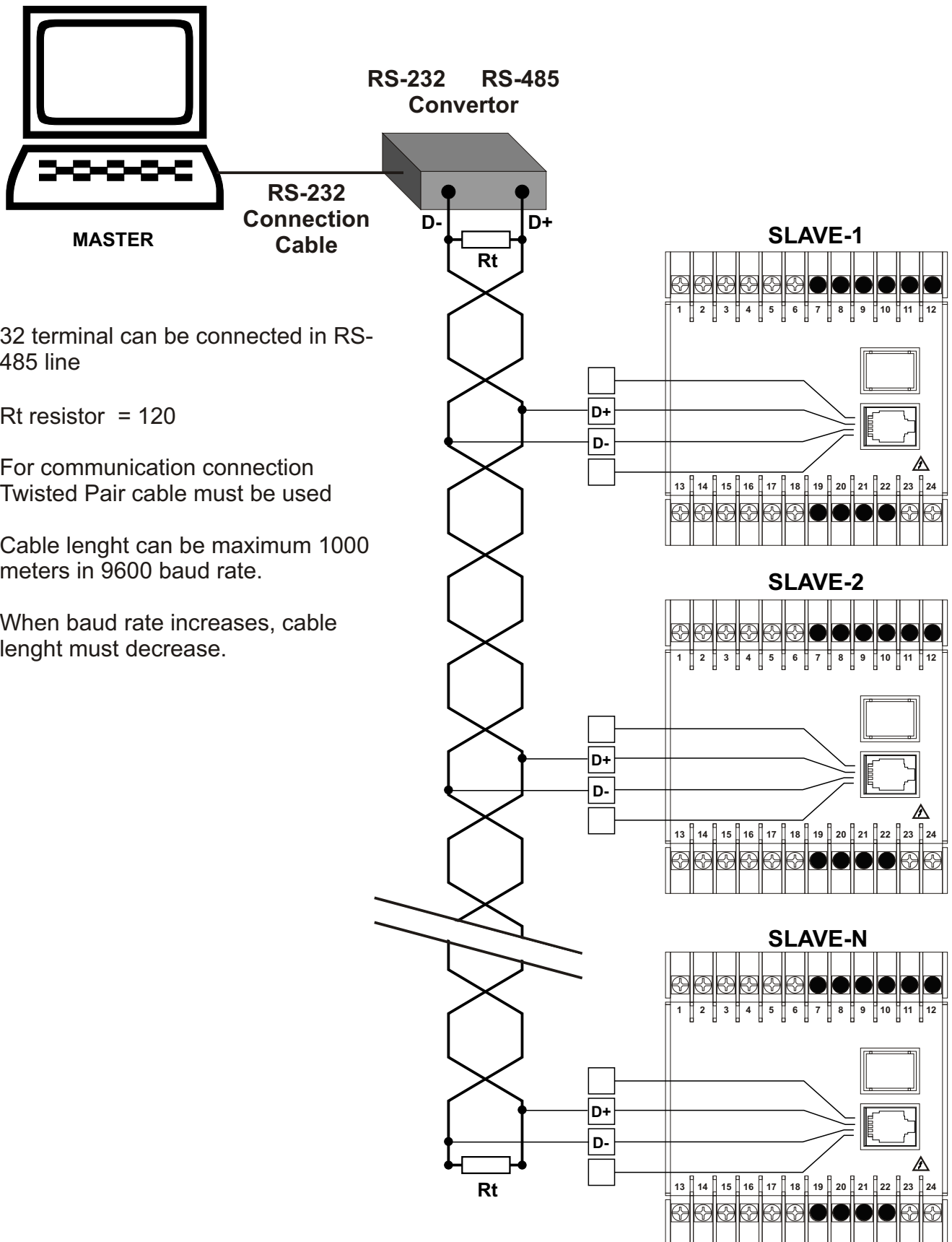

32 terminal can be connected in RS-485 line

R_t resistor = 120

For communication connection
Twisted Pair cable must be used

Cable length can be maximum 1000
meters in 9600 baud rate.

When baud rate increases, cable
length must decrease.

6.3 Installing RS-232 / RS-485 Serial Communication Modules to the Device

Pull the cover case with your hand through rear side as explained in “Installing and Pulling Out Output Modules” section. Pull the modules in Module-1 and Module-2 socket through rear side. Separate supply card which is at the bottom of the equipment by lifting the locking tabs located on front panel. Pay attention to cable connection between top and bottom cards. Damages in this cable makes the equipment not to work.

RS-232 or RS-485 module is plugged into socket signed as A and B. Hold the equipment to be it's front panel is on your right, communication socket is on your left and module connection socket with 5 terminals on above. Plug in module connection socket with 5 terminals to the socket on Top Card. Do the same things for terminal socket in bottom card and connection socket with 3 terminals. Plug in bottom card to the place in front panel. Install the modules which are pulled out to Module-1 and Module-2 socket. Replace the cover case by taking care of the terminal numbers should be at right position.

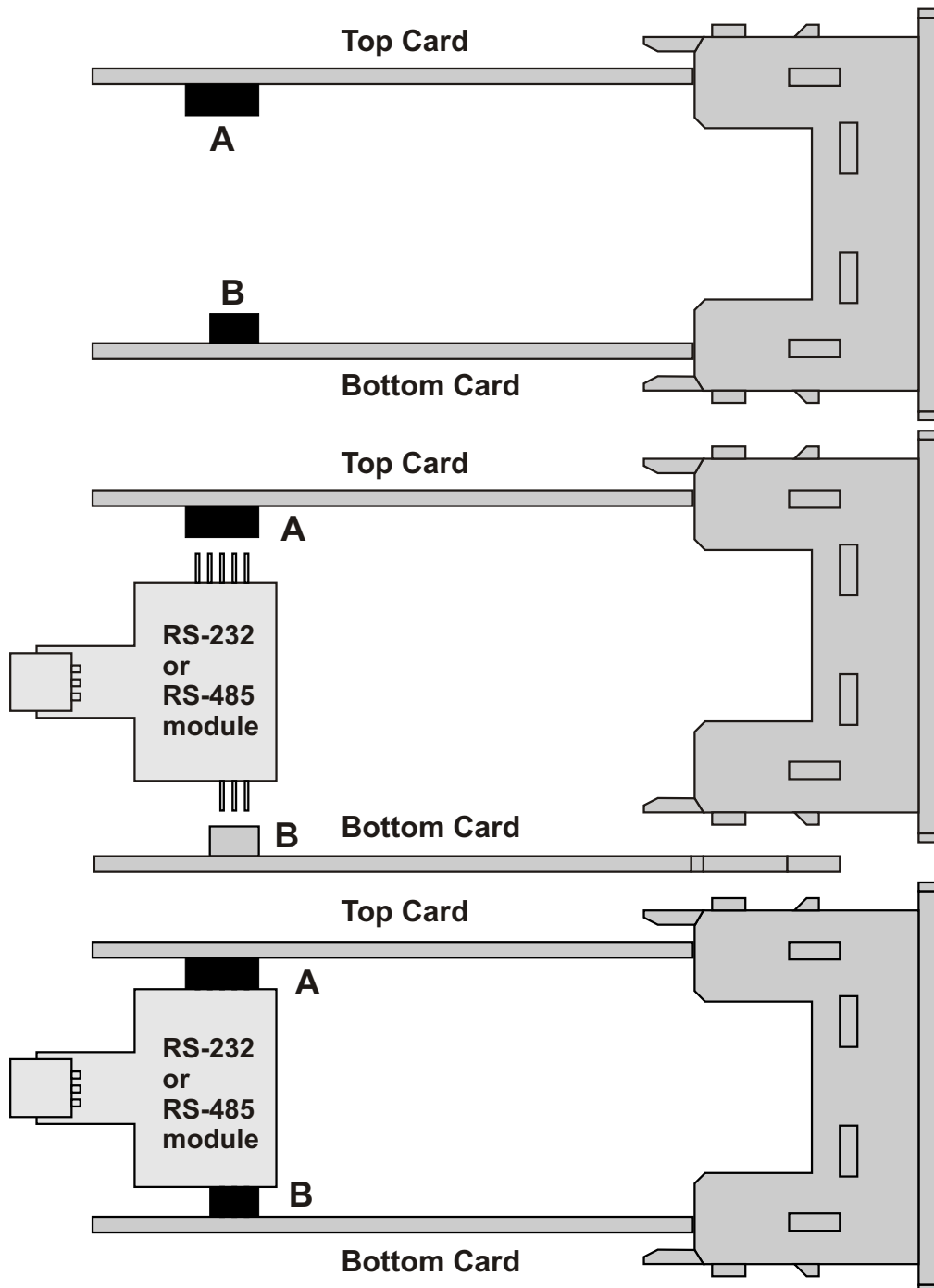

7. Definition of Front Panel and Accessing to the Set Parameters

7.1 Definition of Front Panel

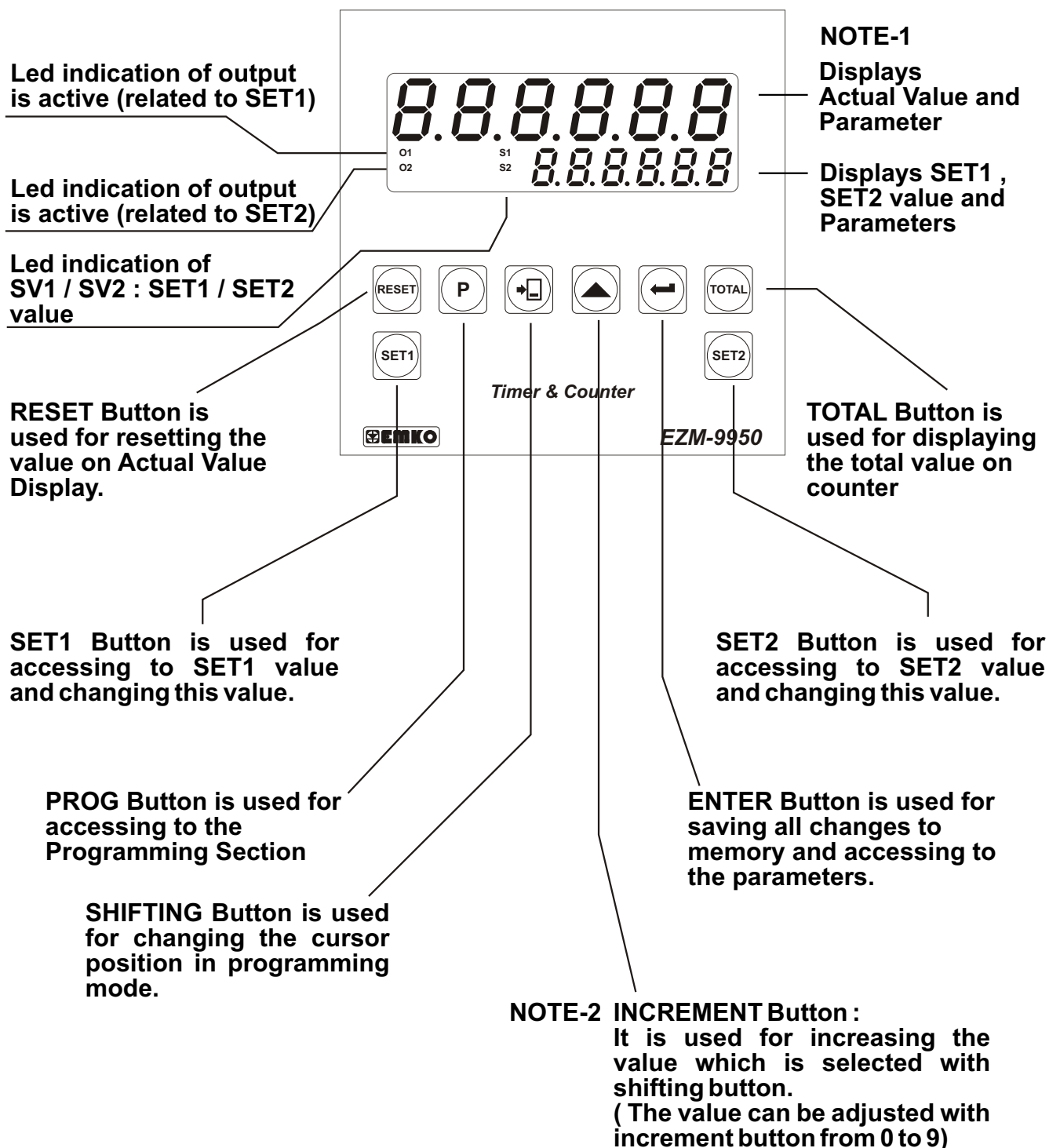

NOTE-1 : Total count value is 12 digits in Counter / “Totalizer Counter” function

NOTE-2 : In Counter / “Totalizer Counter” function if SET1 operation form selection parameter `Pro-22` is `000001`, then SET1 can be negative. While most significant digit (6th digit) of SET1 value is changed from 0 to 9 with increment button, after 9, “-” character is shown. If when “-” character is on the most significant digit (6th digit) of SET1 value and Enter button is pressed, SET1 value becomes negative.

7.2 Power On Observation of EZM - 9950 Programmable Timer & Counter and Software Revision on the Display

When power is applied to the device, software revision number of the controller is momentarily illuminated on actual value display. Then operation screen is observed.

When power on, view of the screen is shown below:

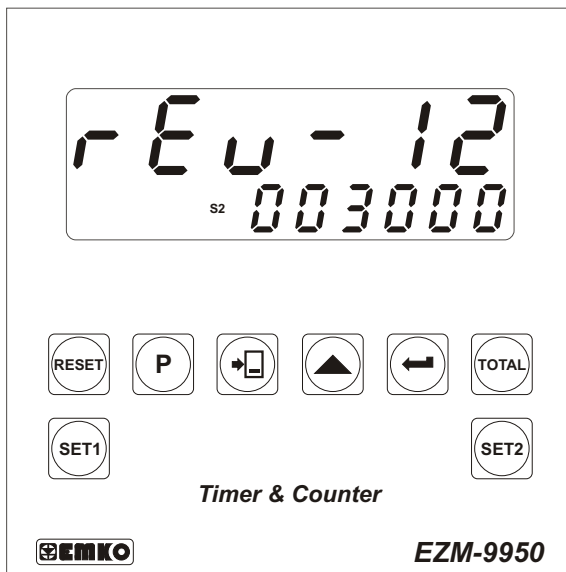
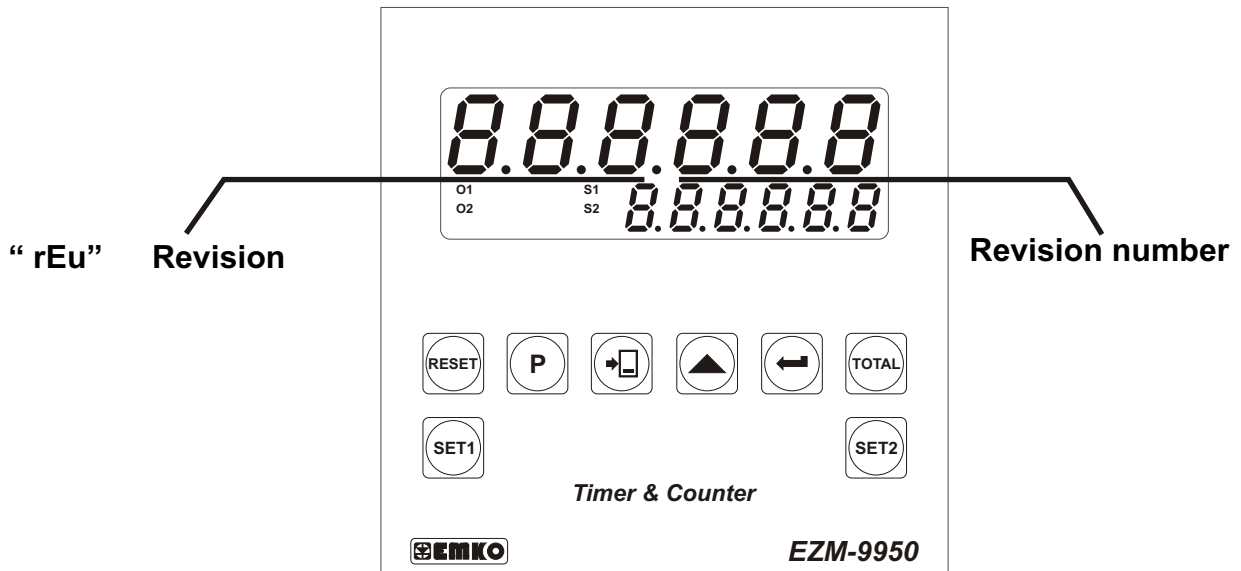

Software Revision

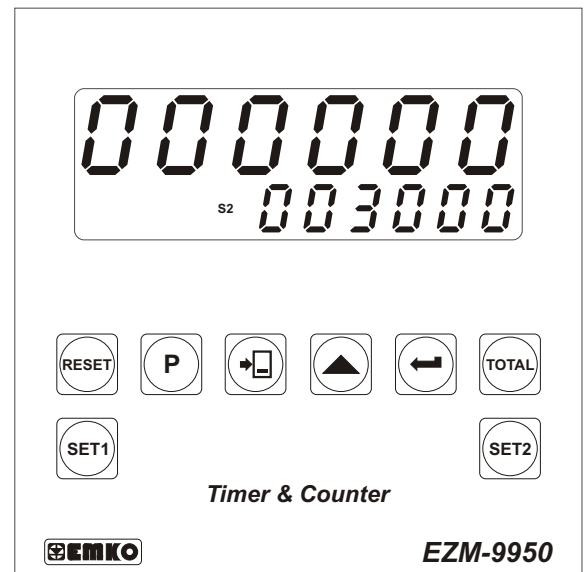

Operation Screen is shown



If there is an unexpected situation while opening the device, power off the device and inform a qualified personnel.

7.3 Adjustment of SET1 and SET2 Values

Changing SET2 value in Counter / "Totalizer Counter" functions

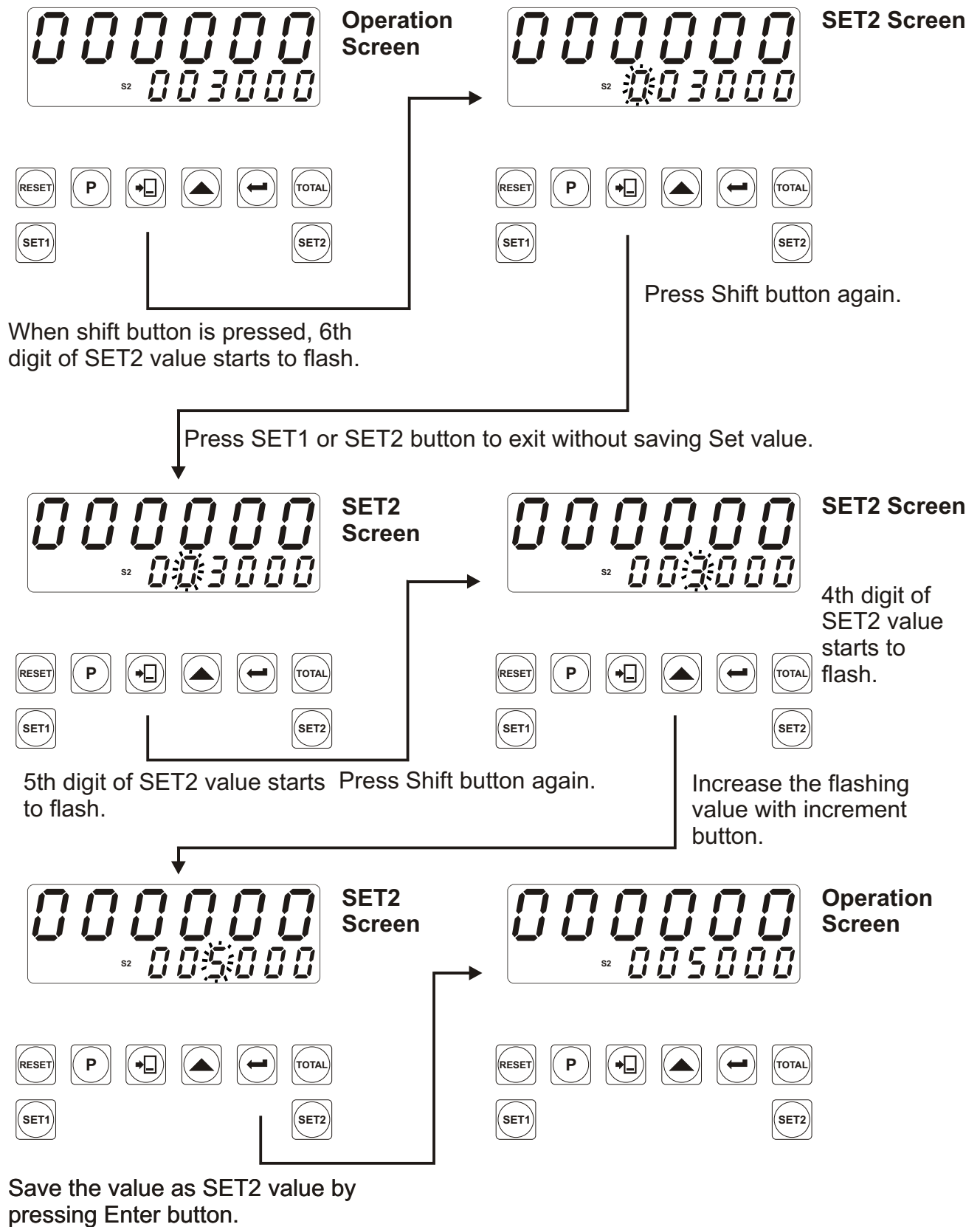

If **Pro-28** Reset and Set Protection parameter is **000002**, **000003** or **000005** then SET2 value can not be changed. For details, refer to parameters section.

Changing SET1 value in Counter / "Totalizer Counter" function

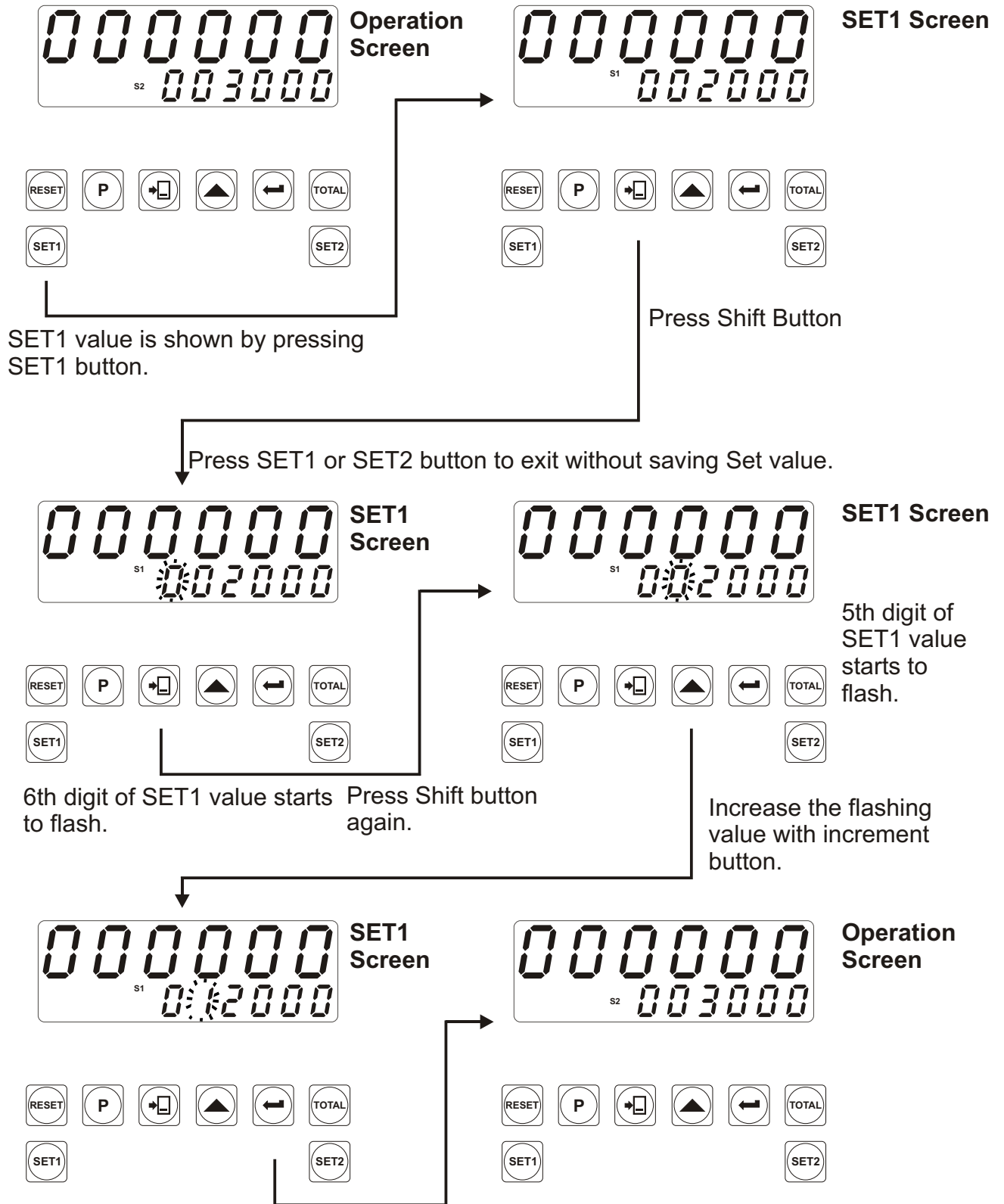

If **Pro-28** Reset and Set Protection parameter is **000002**, **000003** or **000004**, then SET1 value can not be changed. For details, refer to parameters section.

7.4 Resetting Count Value and Observing Total Count Value in COUNTER / "TOTALIZER COUNTER" Function

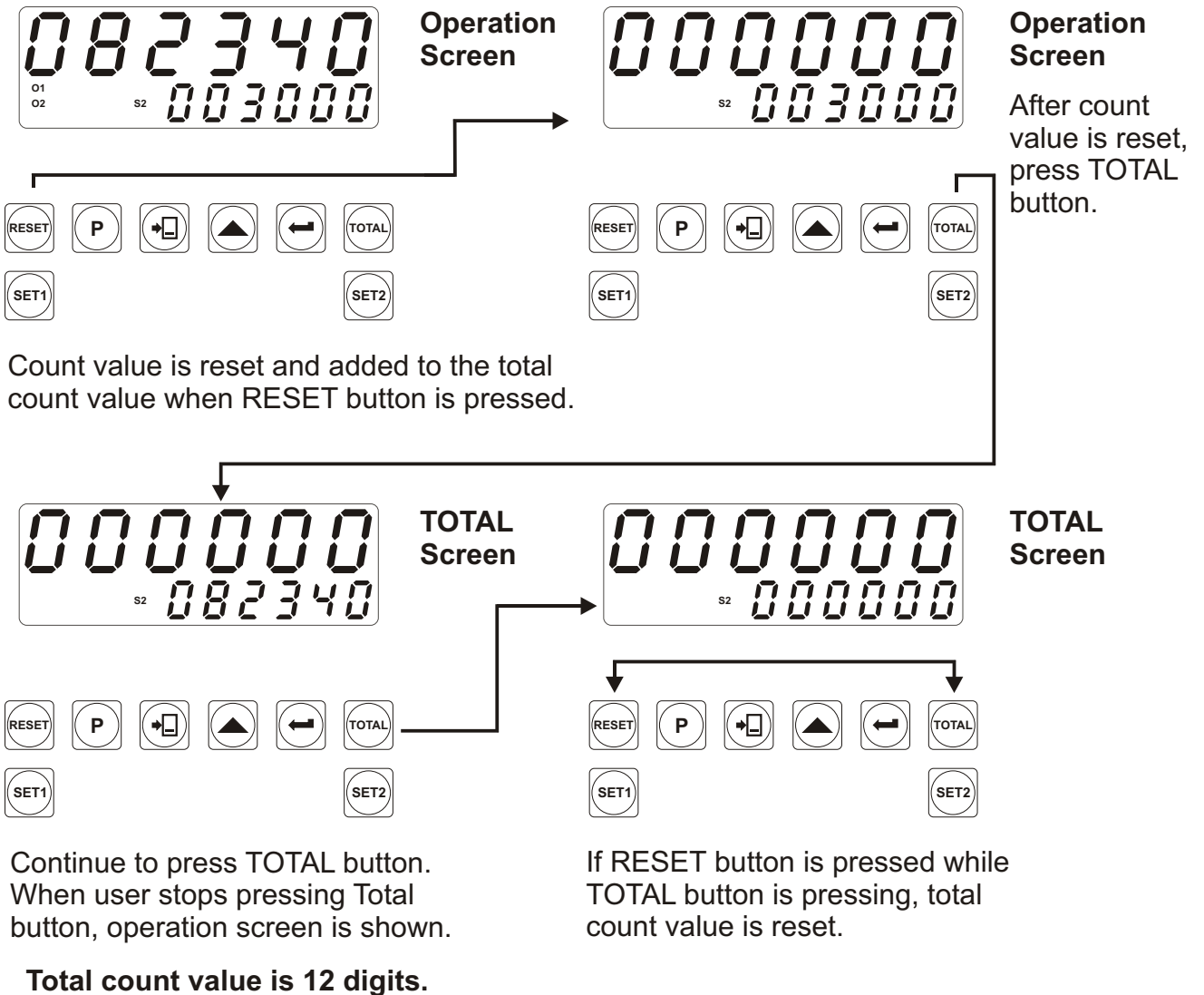

When user stops pressing the buttons, operation screen is shown.

Note-1: If manual reset is applied when counting direction parameter $Pr0-19$ is 000001 difference between SET2 value and value on the screen is added to the total count value

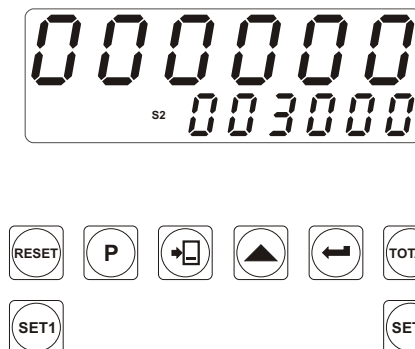

Operation Screen

Note-2: Becoming zero of count value is for if counting direction parameter $Pr0-19$ is 000000 , if counting direction parameter $Pr0-19$ is 000001 count value becomes equal to SET2 value



If $Pr0-28$ Reset and Set Protection parameter is 000001 or 000003 then total count value can not be reset. For details, refer to parameters section.



RESET operation can be realized by Reset button or applying signal to the RESET input. These two operations are named MANUAL RESET in parameters section. At the end of the MANUAL RESET operation, if counting direction parameter $Pr0-19$ is 000000 then count value becomes 000000 . If counting direction parameter $Pr0-19$ is 000001 then count value becomes equal to SET2 value.

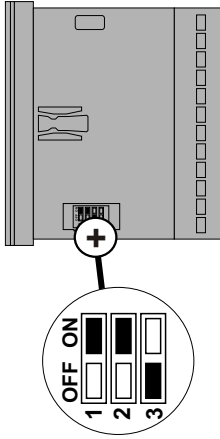

7.5 COUNTER / "TOTALIZER COUNTER" Parameters

SET1

SET value for Output-1. Control of the Output-1 is done according to this value. It can be adjusted from `000000` to `999998`

If SET1 operation form selection parameter `Pro-22` is selected operation with offset `000001`, it can be adjusted from `-999999` to `999998`

SET2

SET value for Output-2. Control of the Output-2 is done according to this value. It can be adjusted from `000000` to `999998`

`Pro-01`

Input Types and Functions

`000000`

Upcount on rising edge of Ch-A input(INC)

`000001`

Downcount on rising edge of Ch-A input(DEC)

`000002`

Upcount on rising edge of Ch-A input and downcount on rising edge of Ch-B input (INC / DEC)

`000003`

Upcount on rising edge of Ch-A and Ch-B inputs (INC / INC)

`000004`

Upcount on rising edge of Ch-A input when Ch-B is at 0, downcount on rising edge of Ch-A input when Ch-B is at 1.(UP / DOWN)

`000005`

x1 phase shifting (for incremental encoders)

`000006`

x2 phase shifting (for incremental encoders)

`000007`

x4 phase shifting (for incremental encoders)

`Pro-04`

Pulse Time of Ch-A, Ch-B, Reset and Pause Inputs

It is used to protect against the electrical contact debounce or the signal that is less than the determined pulse time.

It can be adjusted from `000000` to `000250` msec. If it's adjusted to `000000` then there is no time protection for Ch-A and Ch-B. If the parameter value is adjusted `000000` or `000001` then Reset and Pause protection times are accepted as 2 msec.

`Pro-06`

Output Functions

`000000`

Manual Reset-1. Device continues to count till manual reset is applied. Output-2 pulse time `Pro-17` is not considered.

`000001`

Manual Reset-2. Device continues to count till count value reaches to SET2 value. For starting to count again, manual reset input must be active. Output-2 pulse time `Pro-17` is not considered.

`000002`

Manual Reset-3. It operates like Manual Reset-1. Only difference, output-2 pulse time `Pro-17` is considered.



In operation with Manual or Automatic Reset, at the end of the reset operation, if counting direction parameter `Pro-19` is `000000` (0 P), count value becomes `000000`. If `Pro-19` is `000001` (P), count value becomes SET2.



For details on parameters, refer to Section 8 (Program Parameters).

000003 **Automatic Reset-1.** Count value is reset when it reaches to SET2 value (For 0 P). Count value is added to total count value and device starts to count from **000000**

000004 **Automatic Reset-2.** Counting is stopped when count value reaches to SET2 value. Count value becomes zero (for 0 P) at the end of output-2 pulse time **Pr0-17**. And count value is added to total count value. Device starts to count from **000000**

000005 **Automatic Reset-3.** Count value becomes zero (for 0 P) when it reaches to SET2 value and count value is added to total count value. Device starts to count from **000000**. Meanwhile, SET2 value is shown in actual value display, count value is shown at the end of output-2 pulse time **Pr0-17**

000006 **Automatic Reset-4.** Counting is continued when count value reaches to SET2 value. Count value becomes zero (for 0 P) at the end of Output-2 pulse **Pr0-17** time and it is added to total count value. Device starts to count from **000000**

000007 **Automatic Reset-5.** Counting is continued till manual reset is active. Output-1 and Output-2 pulse times (**Pr0-16** and **Pr0-17**) are not considered. **It is preferred if upcount and downcount are done at the same time.**



In operation with Manual or Automatic Reset, at the end of the reset operation, if counting direction parameter **Pr0-19** is **000000** (0 P), count value becomes **000000**. If **Pr0-19** is **000001** (P), count value becomes SET2.

Pr0-14

Operation form for Output-1

000000

Output - 1 Normally non-energised

000001

Output - 1 Normally energised

Pr0-15

Operation form for Output-2

000000

Output - 2 Normally non-energised

000001

Output - 2 Normally energised

Pr0-16

Output-1 Pulse Time

Energising time for Output-1. It can be adjusted from **000000** to **009999**. If it is **000000**, then it operates indefinitely.

Pr0-17

Output-2 Pulse Time

Energising time for Output-2. It can be adjusted from **000000** to **009999**. If it is **000000**, then it operates indefinitely.

Pr0-19

Selection of counting direction

000000

Upcount(0 Preset)

000001

Downcount(Preset 0)



For details on parameters, refer to Section 8 (Program Parameters).

Pro-20 Point Position for display

- 000000** No point
- 000001** Between first and second digits
- 000002** Between second and third digits
- 000003** Between third and fourth digits
- 000004** Between fourth and fifth digits

Pro-21 Saving Count Value (Power down back-up)

- 000000** Count value is saved to memory when power is off and restored on power up.
- 000001** Count value is not saved to memory when power is off

Pro-22 Selection of SET1 Operation Form

- 000000** Operating without offset. It can be adjusted from **000000** to **999998**
- 000001** Operating with offset. SET1 can be adjusted SET1 = SET2+SET1

Pro-23 Slave Address

Device address for serial communication bus.
It can be adjusted from **000001** to **000247**

Pro-24 Selection of Modbus Protocol Type

- 000000** MODBUS ASCII communication protocol is selected.
- 000001** MODBUS RTU communication protocol is selected

Pro-25 Parity

- 000000** No parity
- 000001** Odd parity
- 000002** Even parity

Pro-26 Baud Rate

- 000000** 1200 Baud Rate
- 000001** 2400 Baud Rate
- 000002** 4800 Baud Rate
- 000003** 9600 Baud Rate
- 000004** 19200 Baud Rate



For details on parameters, refer to Section 8 (Program Parameters).

Pro-27

Stop Bit

000000

1 Stop Bit

000001

2 Stop Bits

Pro-28

Reset and Set protection (Accessing from front panel)

000000

There is no Reset and Set protection

000001

Reset Button protection is active

000002

SET1 and SET2 protection is active

000003

Reset Button , SET1 and SET2 protection is active (Full protection)

000004

SET1 protection is active

000005

SET2 protection is active

Pro-30

Multiplication Coefficient

Count value is multiplied with this value. It can be adjusted from 000001 to 999999 . If it is 010000 , it has no effect.

Pro-PS

Program Password

It is used for accessing to the program parameters.

It can be adjusted from 000000 to 009999 . If it is 000000 , there is no password protection.



For details on parameters, refer to Section 8 (Program Parameters).

7.5.1 COUNTER / "TOTALIZER COUNTER" Applications Examples

EXAMPLE-1 :

There is a production band like in diagram below. Bottles are perceived by a proximity sensor in Ch-A. If

$Pr0-01 = 000000$; $Pr0-30 = 010000$;

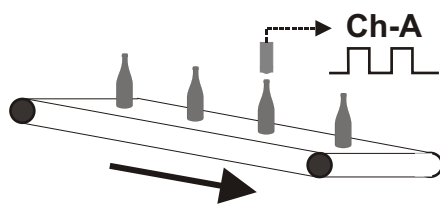

Counting the bottles is done with upcount by using only Ch-A input. When user reset count value with manual reset, count value is added to total count value.

EXAMPLE-2 :

There is a cloth workbench. An encoder with 100 pulse is connected to this system. The encoder is connected to Ch-A and Ch-B inputs.

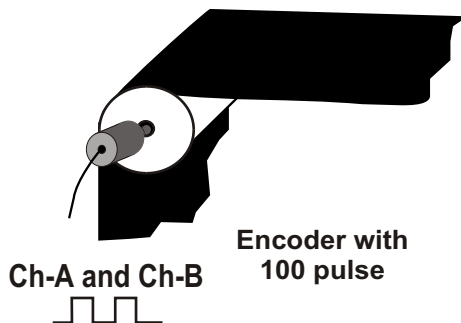

$Pr0-01 = 000005$; $Pr0-04 = 000000$;
 $Pr0-19 = 000000$; $Pr0-30 = 010000$;

You wish to display 200 in actual value display for a drive pulley going forward of 100 cm. If you want to display cloth length in actual value display, you must adjust coefficient parameter $Pr0-30$ like in below:

$Pr0-30 = \frac{\text{Measured cloth length}}{\text{Value on the screen}}$

$Pr0-30$ Coefficient must be = $100/200 = "00.5000"$

After adjustment of coefficient, calculated value is cloth length and you can see this value in actual value display.

If you want to display the speed of the drive pulley as dm instead of cm $Pr0-20$ point position for display parameter must be 000001 , if m instead of cm, this parameter must be 000002

EXAMPLE-3 :

There is a system like in the diagram below. Ch-A is used for measuring the flow.

If

$Pr0-01 = 000000$; $Pr0-30 = 010000$

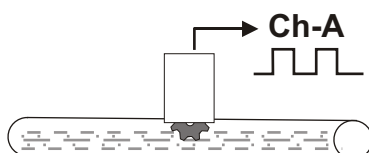

In this application, total amount of flow is measured. If it is known how many pulses are being sent for each liter from the sensor in Ch-A we can measure the desired value by changing the $Pr0-30$ parameter.

For example if sensor gives 10 pulses for 1 liter fluid flow and we want to observe the liquid quantity as liter, coefficient parameter $Pr0-30$ parameter value must be $Pr0-30 = 1\text{Lt}/10\text{ pulse} = "00.1000"$

EXAMPLE - 4 :

There is a cutting unit below. 100-pulse encoder is connected to Ch-A and Ch-B inputs.

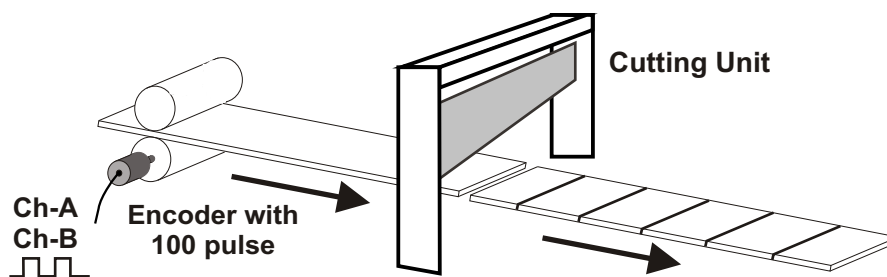

If $Pr_0-01 = 000005$; $Pr_0-04 = 000000$; $Pr_0-19 = 000000$;
 $Pr_0-22 = 000001$ And $Pr_0-30 = 010000$;

If Pr_0-22 parameter is 000001 , then device operates with offset. If SET1 is negative value, then Output-1 will be active in SET2-SET1. This option offers us to solve wrong cutting problem on the speedy mechanic, by reaching slowly to the target.

(SET1=SET1+SET2)

For example ;if SET1 = -000100 ; SET2 = 000500 ; then SET1 = -100+500 = 400

If more sensitivity is needed, Pr_0-01 parameter can be selected 000006 or 000007

For example, while x1 phase shifting counting is performed in a system with a cutting unit as shown above, a 100-pulse encoder is connected to Ch-A and Ch-B inputs. If the system is advanced 100 cm for 50 encoder pulses, so it is advanced 2 cm with 1 encoder pulse.

When x2 phase shifting counting is performed, for the system is being advanced 100 cm, 100 encoder pulses are needed. In this case, the system is advanced 1 cm with 1 encoder pulse.

When x4 phase shifting counting is performed, for the system is being advanced 100 cm, 200 encoder pulses are needed. In this case, the system is advanced 0.5 cm with 1 encoder pulse.

Sensitivity of the system is changed from 2 cm to 0.5 cm.

EXAMPLE-5 :

There are two sensors in Ch-A and Ch-B inputs for determining the amount of the liquid in Channel-A and Channel-B. Multiplication coefficient parameter Pr_0-30 is adjusted to converts the pulses to observe the amount of the liquid exactly in the actual value screen. (For example liter)

For observing total amount of liquid Pr_0-01 must be 000003

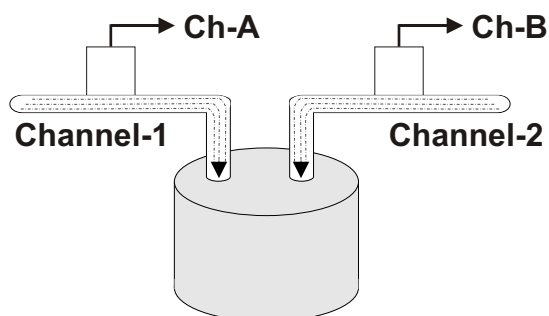

If the tank is filled with liquid 20 liters from Channel-1 and 40 liters from Channel-2, 60 liters is observed in actual value screen.

If Output-1 controls the Channel-1, Output-2 controls the Channel-2, SET1 is 20 and SET2 is 40, then it is possible to close the system after filling the tank with 20 liters from Channel-1 and 40 liters from Channel-2

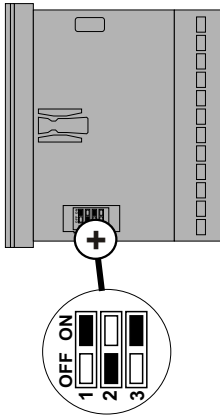

7.6 BATCH COUNTER Parameters

SET1

SET value for Output-1. Control of the Output-1 is done according to this value. It can be adjusted from $\boxed{000000}$ to $\boxed{999998}$

SET2

SET value for Output-2. Control of the Output-2 is done according to this value. It can be adjusted from $\boxed{000000}$ to $\boxed{999998}$

$\boxed{Pr0-01}$

Input Types and Functions

$\boxed{000000}$

Upcount on rising edge of input Ch-A (INC)

$\boxed{000001}$

Downcount on rising edge of input Ch-A (DEC)

$\boxed{000002}$

Upcount on rising edge of input Ch-A and downcount on rising edge of input Ch-B (INC / DEC)

$\boxed{000003}$

Upcount on rising edge of input Ch-A and Ch-B (INC / INC)

$\boxed{000004}$

Upcount on rising edge of Ch-A input when Ch-B is at 0, downcount on rising edge of Ch-A input when Ch-B is at 1. (UP / DOWN)

$\boxed{000005}$

x1 phase shifting (for incremental encoders)

$\boxed{000006}$

x2 phase shifting (for incremental encoders)

$\boxed{000007}$

x4 phase shifting (for incremental encoders)

$\boxed{Pr0-04}$

Pulse Time of Ch-A, Ch-B, Reset and Pause Inputs

It is used to protect against the electrical contact debounce or the signal that is less than the determined pulse time.

It can be adjusted from $\boxed{000000}$ to $\boxed{000250}$ msec. If it's adjusted to $\boxed{000000}$ then there is no time protection for Ch-A and Ch-B. If the parameter value is adjusted $\boxed{000000}$ or $\boxed{000001}$ then Reset and Pause protection times are accepted as 2 msec.



When SET1 value is shown on the screen if MANUAL RESET is applied, batch count value, when SET2 value is shown on the screen if MANUAL RESET is applied, normal count value becomes zero.



In operation with Manual or Automatic Reset, at the end of the reset operation, if counting direction parameter $\boxed{Pr0-19}$ is $\boxed{000000}$ (0 P), count value becomes $\boxed{000000}$. If $\boxed{Pr0-19}$ is $\boxed{000001}$ (P), count value becomes SET2. For both conditions (0 P or P 0), batch count value becomes $\boxed{000000}$



For details on parameters, refer to Section 8 (Program Parameters).

Pro-06

Output Functions

000000

Manual Reset. BATCH counting operation continues until manual reset input is active.

000001

Automatic Reset. BATCH counting operation continues until Batch count value reaches to SET1 value. When Batch count value is equal to SET1 value, Batch count value becomes zero (for 0 P) and device starts to count again.

Pro-14

Operation Form of Output-1

000000

Output - 1 Normally non-energised

000001

Output - 1 Normally energised

Pro-15

Operation Form of Output-2

000000

Output - 2 Normally non-energised

000001

Output - 2 Normally energised

Pro-16

Output-1 Pulse Time

Energising time for Output-1. It can be adjusted from 000000 to 009999. If it is 000000, then it operates indefinitely.

Pro-17

Output-2 Pulse Time

Energising time for Output-2. It can be adjusted from 000000 to 009999. If it is 000000, then it operates indefinitely.

Pro-19

Selection of counting direction

000000

Upcount (0 Preset)

000001

Downcount (Preset 0)

Pro-20

Point Position for display

000000

No point

000001

Between first and second digits

000002

Between second and third digits

000003

Between third and fourth digits

000004

Between fourth and fifth digits

Pro-21

Saving Count Value (Power down back-up)

000000

Count value is saved power is off and restored on power up.

000001

Count value is not saved to memory when power is off

Pro-23

Slave Address

Device address for serial communication bus. It can be adjusted from 000001 to 000247



For details on parameters, refer to Section 8 (Program Parameters).

Pro-24

Selection of Modbus Protocol Type

000000

MODBUS ASCII communication protocol is selected.

000001

MODBUS RTU communication protocol is selected

Pro-25

Parity

000000

No parity

000001

Odd parity

000002

Even parity

Pro-26

Baud Rate

000000

1200 Baud Rate

000001

2400 Baud Rate

000002

4800 Baud Rate

000003

9600 Baud Rate

000004

19200 Baud Rate

Pro-27

Stop Bit

000000

1 Stop Bit

000001

2 Stop Bits

Pro-28

Reset and Set protection (Accessing from front panel)

000000

There is no Reset and Set protection

000001

Reset Button protection is active

000002

SET1 and SET2 protection is active

000003

Reset Button , SET1 and SET2 protection is active (Full protection)

000004

SET1 protection is active

000005

SET2 protection is active

Pro-30

Multiplication Coefficient

Count value is multiplied with this value. It can be adjusted from 000001 to 999999 .If it is 010000 , it has no effect.

Pro-PS

Program Password

It is used for accessing to the program parameters.

It can be adjusted from 000000 to 009999 . If it is 000000 , there is no password protection.



For details on parameters, refer to Section 8 (Program Parameters).

7.6.1 BATCH COUNTER Applications Examples

EXAMPLE-1 :

There is a production band like in diagram below. Bottles are perceived by a proximity sensor in Ch-A. If

$Pr_0-01 = 000000$; $Pr_0-30 = 010000$;

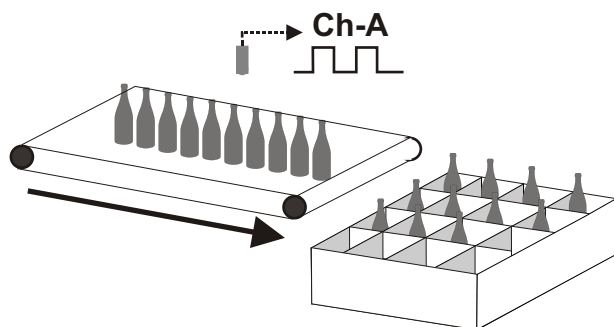

Device is used in a packing line as shown on the left. Bottles must be counted into packs of 4 bottles and dispatched in a box containing a batch of 4 packs. According to this, SET1 and SET2 are defined 4. 4 pieces of packet which contain a batch of 4 series are allowed to be formed.

If $Pr_0-06 = 000001$ (Automatic Reset-1); after arranging the bottles in a box as shown on the left, output-1 will be active and it stops the system. Batch count value is reset and it will be ready to count the new series.

EXAMPLE-2 :

There is a cloth workbench. An encoder with 100 pulse is connected to this system. The encoder is connected to Ch-A and Ch-B inputs.

If $Pr_0-01 = 000005$; $Pr_0-04 = 000000$;
 $Pr_0-19 = 000000$ And $Pr_0-30 = 010000$;

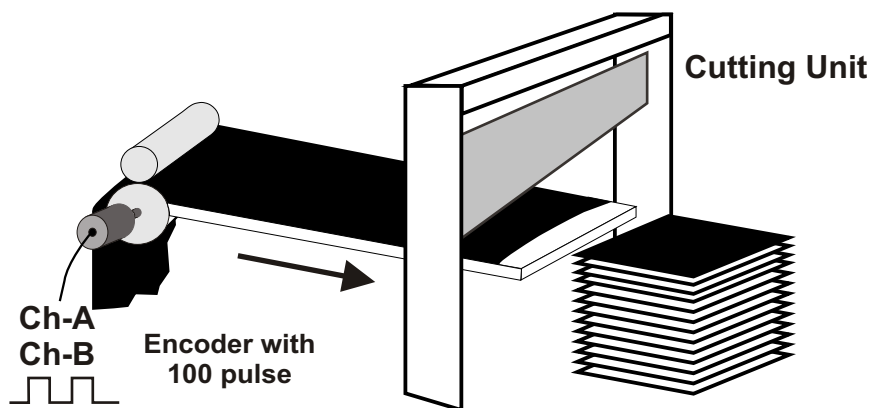

Coefficient parameter is adjusted to be able to observe the cloth length in actual value screen. If we want to be cut the cloth in same length at 5 m and stopped the system when 40 pieces of 5 m cloths are formed, SET1 must be 40 and SET must be 5.

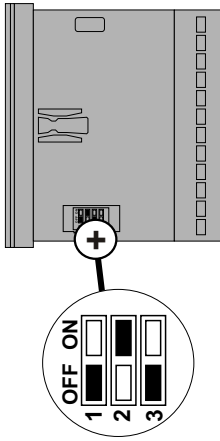

7.7 TIMER Parameters

SET1

SET value for Output-1. Control of the Output-1 is done according to this value. It can be changed by time unit and scale selection parameter `Pr0-05`

SET2

SET value for Output-2. Control of the Output-2 is done according to this value. It can be changed by time unit and scale selection parameter `Pr0-05`

`Pr0-05`

Time Unit and Scale Selection

`000000`

Hour / Minute

It can be adjusted from `000000` to `009959`

`000001`

Minute / Second

It can be adjusted from `000000` to `009959`

`000002`

Second / Millisecond

It can be adjusted from `000000` to `009999`

`000003`

Hour / Minute

It can be adjusted from `000000` to `002359`

`000004`

Hour

It can be adjusted from `000000` to `099999`

`000005`

Minute

It can be adjusted from `000000` to `099999`

`000006`

Second

It can be adjusted from `000000` to `099999`

`Pr0-06`

Output Functions

`000000`

Manual Reset-1. Device continues to count till manual reset is applied. Output-2 pulse time `Pr0-17` is not considered.

`000001`

Manual Reset-2. Device continues to count till count value reaches to SET2 value. For starting to count again, manual reset input must be active. Output-2 pulse time `Pr0-17` is not considered.

`000002`

Manual Reset-3. It operates like Manual Reset-1. Only difference, output-2 pulse time `Pr0-17` is considered.

`000003`

Automatic Reset-1. Count value becomes zero (0 P) when it reaches to SET2 value. Count value is added to total count value and device starts to count from `000000`

`000004`

Automatic Reset-2. Counting is stopped when count value reaches to SET2 value. Count value is becomes zero (0 P) at the end of output-2 pulse time `Pr0-17` And device starts to count again.



In operation with Manual or Automatic Reset, at the end of the reset operation, if counting direction parameter `Pr0-19` is `000000` (0 P), count value becomes `000000`. If `Pr0-19` is `000001` (P), count value becomes SET2.



For details on parameters, refer to Section 8 (Program Parameters).

000005 **Automatic Reset-3.** Count value becomes zero (0 P) when it reaches to SET2 value. Device starts to count again. Meanwhile, SET2 value is shown in actual value display, count value is shown at the end of output-2 pulse time **Pro-17**

000006 **Automatic Reset-4.** Counting is continued when count value reaches to SET2 value. Count value becomes zero (0 P) at the end of Output-2 pulse time **Pro-17**. Device starts to count again.

000007 **Automatic Reset-5.** When count value reaches to SET2 value, SET1 changes position, count value becomes zero (for 0 P) Output-1 and Output-2 does not change position until count value reaches to SET2 value.



In operation with Manual or Automatic Reset, at the end of the reset operation, if counting direction parameter **Pro-19 is **000000** (0 P), count value becomes **000000**. If **Pro-19** is **000001** (P), count value becomes SET2.**

Pro-14 **Operation form for Output-1**

000000 Output - 1 Normally non-energised

000001 Output - 1 Normally energised

Pro-15 **Operation form for Output-2**

000000 Output - 2 Normally non-energised

000001 Output - 2 Normally energised

Pro-16 **Output-1 Pulse Time**

Energising time for Output-1. It can be adjusted from **000000** to **009999**. If it is **000000**, it operates indefinitely.

Pro-17 **Output-2 Pulse Time**

Energising time for Output-2. It can be adjusted from **000000** to **009999**. If it is **000000**, it operates indefinitely.

Pro-19 **Selection of counting direction**

000000 Upcount (0 Preset)

000001 Downcount (Preset 0)

Pro-21 **Saving Count Value (Power down back-up)**

000000 Count value is saved when power is off and restored on power up.

000001 Count value is not saved to memory when power is off

Pro-23 **Slave Address**

Device address for serial communication bus.
It can be adjusted from **000001** to **000247**



For details on parameters, refer to Section 8 (Program Parameters).

Pro-24

Selection of Modbus Protocol Type

000000

MODBUS ASCII communication protocol is selected.

000001

MODBUS RTU communication protocol is selected

Pro-25

Parity

000000

No parity

000001

Odd parity

000002

Even parity

Pro-26

Baud Rate

000000

1200 Baud Rate

000001

2400 Baud Rate

000002

4800 Baud Rate

000003

9600 Baud Rate

000004

19200 Baud Rate

Pro-27

Stop Bit

000000

1 Stop Bit

000001

2 Stop Bits

Pro-28

Reset and Set protection (Accessing from front panel)

000000

There is no Reset and Set protection

000001

Reset Button protection is active

000002

SET1 and SET2 protection is active

000003

Reset Button , SET1 and SET2 protection is active (Full protection)

000004

SET1 protection is active

000005

SET2 protection is active

Pro-PS

Program Password

It is used for accessing to the program parameters.

It can be adjusted from 000000 to 099999 . If it is 000000 , there is no password protection.



For details on parameters, refer to Section 8 (Program Parameters).

7.7.1 Timer Applications Examples

EXAMPLE-1 :

There is a switch for giving start and stop signal on PAUSE input.

If $Pr0-05 = 000001$;

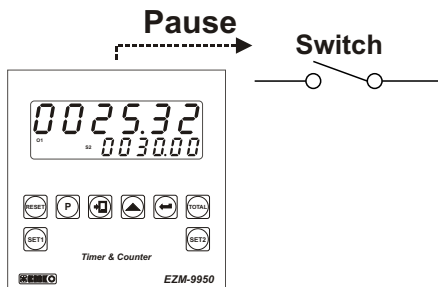

When switch is “On”, counting is started (Minute / second). When switch is “Off”, counting is stopped. Time between opening and closing of the switch is observed on actual value screen.

Expired time can be reset with manual reset. If total operation time is wanted to be observed on the screen, manual reset is not applied and after Start/Stop operation counting is started from the last count value.

NOTE: If output-1 and output-2 is wanted to be used as an alarm output;

For example SET1 = 10.00 ; SET2= 30.00 and $Pr0-06 = 000002$

Device starts to count (Minute / second) when switch is “On”. It is possible to have a warning when SET1 and SET2 times are expired and stopping the alarm at the end of the Output-1 and Output-2 pulse times. ($Pr0-16$ And $Pr0-17$)

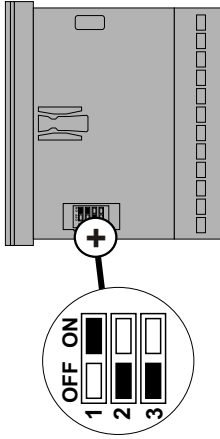

7.8 FREQUENCYMETER / TACHOMETER Parameters

SET1

SET value for Output-1. Control of the Output-1 is done according to this value. It can be adjusted from `000000` to `999998`

SET2

SET value for Output-2. Control of the Output-2 is done according to this value. It can be adjusted from `000000` to `999998`

`Pro-03`

Selection of Measurement Method

`000000`

Frequency or cycle is calculated by measuring cycle time of the signals in Ch-A input

`000001`

Frequency or cycle is calculated by counting the pulses in Ch-A input during the time is set in measurement period parameter `Pro-08`

`Pro-04`

Pulse Time of Ch-A, Ch-B, Reset and Pause Inputs

It is used to protect against the electrical contact debounce or the signal that is less than the determined pulse time.

It can be adjusted from `000000` to `000250` msec. If it's adjusted to `000000` then there is no time protection for Ch-A and Ch-B. If the parameter value is adjusted `000000` or `000001` then Reset and Pause protection times are accepted as 2 msec.

`Pro-07`

Time Out (Input Signal Reset Time)

The actual value is reset, if there is no signal in Ch-A input during this time
It can be adjusted from `000001` to `000099`

`Pro-08`

Measurement Period

Number of pulses is counted during this time
It can be adjusted from `000001` to `000999`

`Pro-09`

Output-1 Function

`000000`

Output-1 is latched. It does not change position until manual reset is applied.

`000001`

Non-latched with hysteresis output is selected.

`000002`

Output-1 is an alarm output. For details, refer to Output-1 Alarm functions parameter `Pro-11`.



For details on parameters, refer to Section 8 (Program Parameters).

Pro-10

Output-2 Function

000000

Output-2 is latched. It does not change position until manual reset is applied.

000001

Non-latched with hysteresis output is selected.

Pro-11

Alarm Functions for Output-1

If Output-1 function parameter Pro-09 is 000002, Output-1 becomes active according to this parameter

000000

High Alarm.

000001

Low Alarm.

000002

Deviation High Alarm.

000003

Deviation Low Alarm.

000004

Deviation Band Alarm.

Pro-12

Hysteresis for Output-1

Hysteresis for Output-1. It is used if Output-1 is non-latched. It can be adjusted from 000000 to 050000

Pro-13

Hysteresis for Output-2

Hysteresis for Output-2. It is used if Output-2 is non-latched. It can be adjusted from 000000 to 050000

Pro-14

Operation form for Output-1

000000

Output - 1 Normally non-energised

000001

Output - 1 Normally energised

Pro-15

Operation form for Output-2

000000

Output - 2 Normally non-energised

000001

Output - 2 Normally energised

Pro-16

Output-1 Pulse Time

Energising time for Output-1. It can be adjusted from 000000 to 009999. If it is 000000, then it operates indefinitely.

Pro-17

Output-2 Pulse Time

Energising time for Output-2. It can be adjusted from 000000 to 009999. If it is 000000, then it operates indefinitely.



For details on parameters, refer to Section 8 (Program Parameters).

Pro-18

Start of Controlling

000000

Controlling is started when the device is energised

000001

Controlling is started when count value reaches to SET1 value.

000002

Controlling is started when count value reaches to SET2 value.

Pro-20

Point Position for display

000000

No point

000001

Between first and second digits

000002

Between second and third digits

000003

Between third and fourth digits

000004

Between fourth and fifth digits

Pro-23

Slave Address

Device address for serial communication bus.

It can be adjusted from 000001 to 000247

Pro-24

Selection of Modbus Protocol Type

000000

MODBUS ASCII communication protocol is selected.

000001

MODBUS RTU communication protocol is selected

Pro-25

Parity

000000

No parity

000001

Odd parity

000002

Even parity

Pro-26

Baud Rate

000000

1200 Baud Rate

000001

2400 Baud Rate

000002

4800 Baud Rate

000003

9600 Baud Rate

000004

19200 Baud Rate

Pro-27

Stop Bit

000000

1 Stop Bit

000001

2 Stop Bits



For details on parameters, refer to Section 8 (Program Parameters).

Pro-28

Reset and Set protection (Accessing from front panel)

000000

There is no Reset and Set protection

000001

Reset Button protection is active

000002

SET1 and SET2 protection is active

000003

Reset Button , SET1 and SET2 protection is active (Full protection)

000004

SET1 protection is active

000005

SET2 protection is active

Pro-29

Frequency / Cycle Multiplication Coefficient

Count value is multiplied with this value. It can be adjusted from 000001 to 009999

Pro-30

Multiplication Coefficient

Count value is multiplied with this value. It can be adjusted from 000001 to 999999 .If it is 010000 , it has no effect.

Pro-PS

Program Password

It is used for accessing to the program parameters.

It can be adjusted from 000000 to 009999 . If it is 000000 , there is no password protection.



For details on parameters, refer to Section 8 (Program Parameters).

7.8.1 FREQUENCYMETER / TACHOMETER Applications Examples

Two different methods are used in Frequency Meter / Tachometer function;

Method -1 : To get frequency or cycle value by measuring the revolution time
(This method is used if the sensor sends one pulse per revolution)

Method -2 : To get frequency or cycle value by counting the pulses during the time is set in `Pro-08` parameter

Method -1 :

If `Pro-03` is `0000000` ;

Measuring starts on rising edge of Ch-A input. Time (T) is between two rising edge.

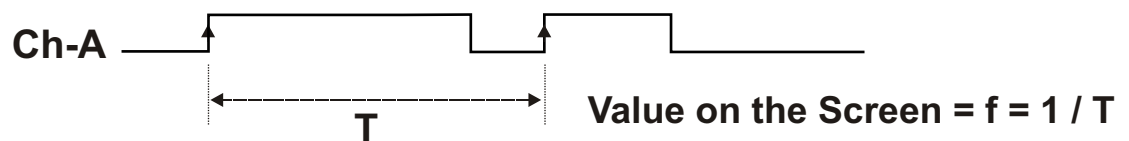

If `Pro-29` parameter is `000001` , `Pro-30` parameter is `010000` , then speed is measured cycle per second.

For measuring the speed cycle per minute, `Pro-29` parameter must be `000060`

For measuring the speed cycle per hour, `Pro-29` parameter must be `003600`

EXAMPLE-1 :

There is a cloth workbench as shown below:

When `Pro-29` parameter is `000001` , `Pro-30` parameter is `010000` , cloth is advanced 80 cm per revolution and 20 cycle / sec is observed on the display.

User can observe cloth length , 80 cm, on the display by changing the `Pro-29` and `Pro-30` Parameter

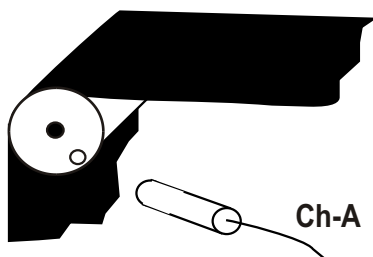

$$\text{Pro-30} = \frac{\text{Cloth Length in one revolution}}{\text{Pro-29} * \text{Value on the display (f)}}$$

If `Pro-29` = 1

`Pro-30` Multiplication coefficient = 80/20 = 4

After adjustment of the parameter, 80 cm / sec is observed on the display.

For dm/sec, point position for display parameter `Pro-20` must be `000001`

For m/sec, point position for display parameter `Pro-20` must be `000002`

For cm / minute, `Pro-29` parameter must be `000060`

For cm / hour, `Pro-29` parameter must be `003600`



This method must be used if speed is over 100 cycle / second

Method -2 :

If **Pr0-03** parameter is **000001** ;

Pulses in Ch-A input is counted during time is set in **Pr0-08** parameter. Average time for one pulse is calculated.

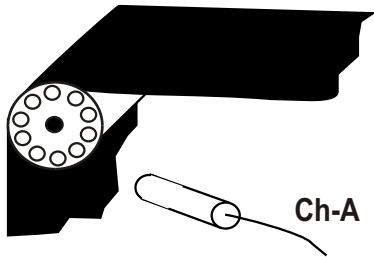

EXAMPLE-2:

For one revolution of cylinder 10 pulse is applied in Ch-A input during **Pr0-08** = **000020**

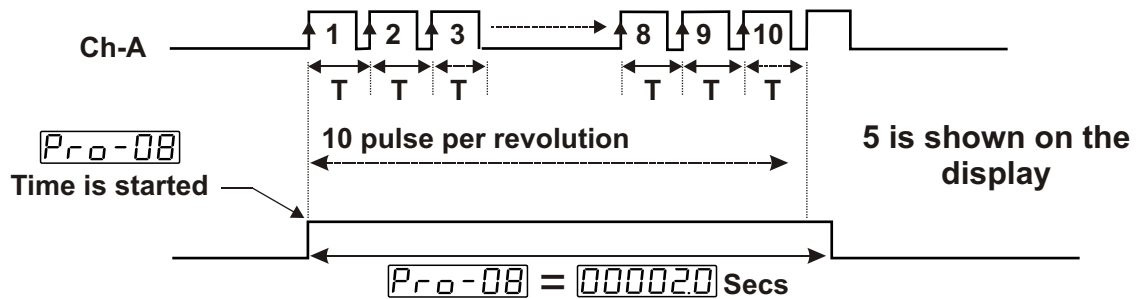

If 10 pulse is applied during 2 secs;
 $T = 2 / 10 = 0.2 \text{sec}$ $f = 1/T$ $f = 5 \text{ cycle / sec}$ is shown on the display

If **Pr0-29** parameter is **000001** and **Pr0-30** parameter is **010000** , speed is measured as cycle per second.

For cycle / minute, **Pr0-29** parameter must be **000060**

For cycle / hour, **Pr0-29** parameter must be **003600**

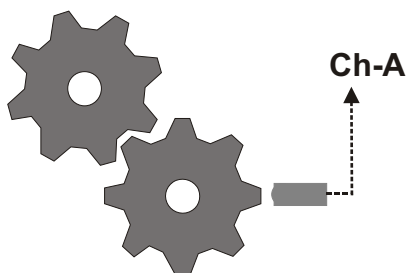

EXAMPLE-3:

8 pulse is applied per revolution during **Pr0-08** = **000005**

If **Pr0-29** parameter is **000001** and **Pr0-30** Parameter is **010000**, speed of the system (cycle per second) is calculated as shown below:

If 8 pulse is applied during 0.5 sec;
 $T = 0.5 / 8 = 0.0625 \text{sec}$ $f = 1/T$ $f = 16 \text{ cycle / sec}$ is shown on the display

For cycle / minute, **Pr0-29** parameter must be **000060**

For cycle / hour, **Pr0-29** parameter must be **003600**

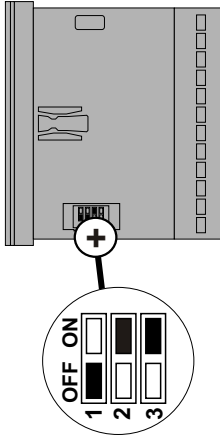

7.9 CHRONOMETER Parameters

SET1

SET value for Output-1. Control of the Output-1 is done according to this value. It can be changed by time unit and scale selection parameter `Pro-05`

SET2

SET value for Output-2. Control of the Output-2 is done according to this value. It can be changed by time unit and scale selection parameter `Pro-05`

`Pro-02`

Input Type and Function Selection for Chronometer

`000000`

Period measurement of signals in Ch-A input

`000001`

Pulse time measurement of signals in Ch-A input

`000002`

Sum of the time difference between Ch-A and Ch-B inputs rising edges

`Pro-04`

Pulse Time of Ch-A, Ch-B, Reset and Pause Inputs

It is used to protect against the electrical contact debounce or the signal that is less than the determined pulse time.

It can be adjusted from `000000` to `000250` msec. If it's adjusted to `000000` then there is no time protection for Ch-A and Ch-B. If the parameter value is adjusted `000000` or `000001` then Reset and Pause protection times are accepted as 2 msec.

`Pro-05`

Time Unit and Scale Selection

`000000`

Hour / Minute

It can be adjusted from `000000` to `009959`

`000001`

Minute / Second

It can be adjusted from `000000` to `009959`

`000002`

Second / Millisecond

It can be adjusted from `000000` to `009999`

`000003`

Hour / Minute

It can be adjusted from `000000` to `002359`

`000004`

Hour

It can be adjusted from `000000` to `099999`

`000005`

Minute

It can be adjusted from `000000` to `099999`

`000006`

Second

It can be adjusted from `000000` to `099999`



In operation with Manual or Automatic Reset, at the end of the reset operation, if counting direction parameter `Pro-19` is `000000` (0 P), count value becomes `000000`. If `Pro-19` is `000001` (P), count value becomes SET2.



For details on parameters, refer to Section 8 (Program Parameters).

Pr0-06

Output Functions

000000

Manual Reset-1. Device continues to count till manual reset is applied. Output-2 pulse time [Pr0-17] is not considered.

000001

Manual Reset-2. Device continues to count till count value reaches to SET2 value. For starting to count again, manual reset input must be active. Output-2 pulse time [Pr0-17] is not considered.

000002

Manual Reset-3. It operates like Manual Reset-1. Only difference, output-2 pulse time [Pr0-17] is considered.

000003

Automatic Reset-1. Count value becomes zero (for 0 P) when it reaches to SET2 value and device starts to count again.

000004

Automatic Reset-2. Counting is stopped when count value reaches to SET2 value. Count value becomes zero (for 0 P) at the end of output-2 pulse time [Pr0-17] And device starts to count again.

000005

Automatic Reset-3. Count value becomes zero (for 0 P) when it reaches to SET2 value. Device starts to count again. Meanwhile, SET2 value is shown in actual value display, count value is shown at the end of output-2 pulse time.

000006

Automatic Reset-4. Counting is continued when count value reaches to SET2 value. Count value becomes zero (0 P) at the end of Output-2 pulse time [Pr0-17] device starts to count again.

000007

Automatic Reset-5. When count value reaches to SET2 value, SET1 changes position, count value becomes zero (0 P). Output-1 and Output-2 do not change position, until count value reaches to SET2 value.



In operation with Manual or Automatic Reset, at the end of the reset operation, if counting direction parameter [Pr0-19] is 000000 (0 P), count value becomes 000000. If [Pr0-19] is 000001 (P), count value becomes SET2.

Pr0-14

Operation form for Output-1

000000

Output - 1 Normally non-energised

000001

Output - 1 Normally energised

Pr0-15

Operation form for Output-2

000000

Output - 2 Normally non-energised

000001

Output - 2 Normally energised

Pr0-16

Output-1 Pulse Time

Energising time for Output-1. It can be adjusted from 000000 to 009999. If it is 000000, then it operates indefinitely.

Pr0-17

Output-2 Pulse Time

Energising time for Output-2. It can be adjusted from 000000 to 009999. If it is 000000, then it operates indefinitely.

Pr0-19

Selection of counting direction

000000

Upcount (0 Preset)

000001

Downcount (Preset 0)



For details on parameters, refer to Section 8 (Program Parameters).

Pro-21

Saving Count Value (Power down back-up)

000000

Count value is saved to memory when power is disconnected and restored on power up.

000001

Count value is not saved to memory when power is disconnected

Pro-23

Slave Address

Device address for serial communication bus.

It can be adjusted from 000001 to 000247

Pro-24

Selection of Modbus Protocol Type

000000

MODBUS ASCII communication protocol is selected.

000001

MODBUS RTU communication protocol is selected

Pro-25

Parity

000000

No parity

000001

Odd parity

000002

Even parity

Pro-26

Baud Rate

000000

1200 Baud Rate

000001

2400 Baud Rate

000002

4800 Baud Rate

000003

9600 Baud Rate

000004

19200 Baud Rate

Pro-27

Stop Bit

000000

1 Stop Bit

000001

2 Stop Bits

Pro-28

Reset and Set protection (Accessing from front panel)

000000

There is no Reset and Set protection

000001

Reset Button protection is active

000002

SET1 and SET2 protection is active

000003

Reset Button , SET1 and SET2 protection is active (Full protection)

000004

SET1 protection is active

000005

SET2 protection is active

Pro-PS

Program Password

It is used for accessing to the program parameters.

It can be adjusted from 000000 to 009999 . If it is 000000 , there is no password protection.



For details on parameters, refer to Section 8 (Program Parameters).

7.9.1 Examples About CHRONOMETER Applications

EXAMPLE-1 :

There is a switch for giving start and stop signal on Ch-A input.

Pro-02 = 000001 ; Pro-04 = 000050 ; Pro-05 = 000001 iken ;

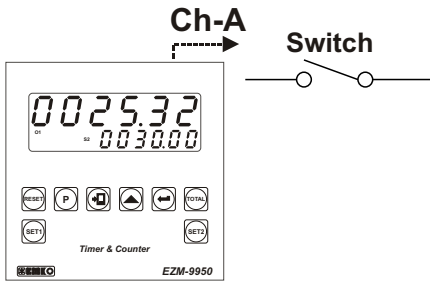

When switch is "On", counting is started (Minute / second). When switch is "Off", counting is stopped. Time between opening and closing of the switch is observed on actual value screen.

Expired time can be reset with manual reset. If total operation time is wanted to be observed on the screen, manual reset is not applied and after Start/Stop operation counting is started from the last count value.

EXAMPLE-2 :

There is a production band as shown below. There are two sensors, first is on Ch-A input used for starting the system, second is on Ch-B input used for stopping the system. If

Pro-02 = 000002 ; Pro-04 = 000050 ; Pro-05 = 000001 ;

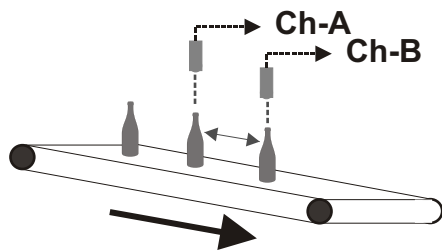

When the object passes in front of the first sensor on Ch-A input, counting is started (Minute / second).

When the object passes in front of the second sensor on Ch-B input, counting is stopped.

Time between two objects can be determined.

The most significant digit of the parameter (1st digit for this parameter) flashes.

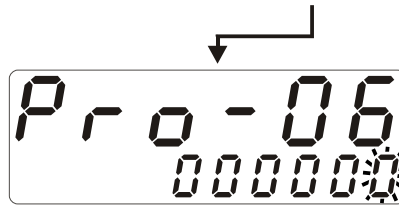

Press PROG button to exit from programming section without doing any changes.

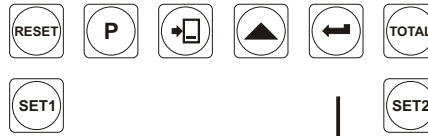

Output Functions

You can change the parameter with INCREMENT button, save it to the memory and pass to the next parameter with ENTER button.

Press ENTER button

The most significant digit of the parameter (1st digit for this parameter) flashes.



Press PROG button to exit from programming section without doing any changes.



Output-1 Operation Form

You can change the parameter with INCREMENT button, save it to the memory and pass to the next parameter with ENTER button.

Press ENTER button

The most significant digit of the parameter (1st digit for this parameter) flashes.



Press PROG button to exit from programming section without doing any changes.

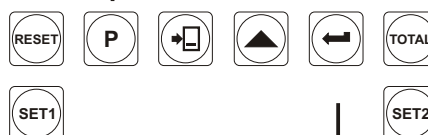

Output-2 Operation Form

You can change the parameter with INCREMENT button, save it to the memory and pass to the next parameter with ENTER button.

Press ENTER button

The most significant digit of the parameter (4th digit for this parameter) flashes.

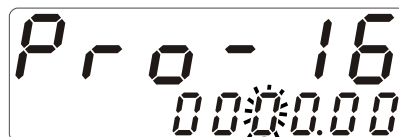

Press PROG button to exit from programming section without doing any changes.

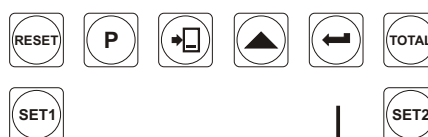

Output-1 Pulse Time

You can change the parameter with INCREMENT button, save it to the memory and pass to the next parameter with ENTER button.

Press ENTER button

The most significant digit of the parameter (4th digit for this parameter) flashes.

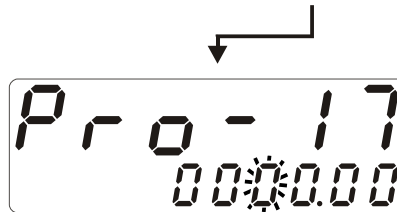

Output-2 Pulse Time

You can change the parameter with INCREMENT button, save it to the memory and pass to the next parameter with ENTER button.

Press PROG button to exit from programming section without doing any changes.

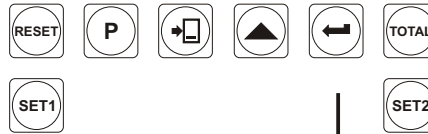

Press ENTER button

The most significant digit of the parameter (1st digit for this parameter) flashes.



Direction of the Counting

You can change the parameter with INCREMENT button, save it to the memory and pass to the next parameter with ENTER button.

Press PROG button to exit from programming section without doing any changes.

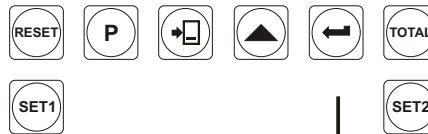

Press ENTER button

The most significant digit of the parameter (1st digit for this parameter) flashes.



Point position for the display

You can change the parameter with INCREMENT button, save it to the memory and pass to the next parameter with ENTER button.

Press PROG button to exit from programming section without doing any changes.



Press ENTER button

The most significant digit of the parameter (1st digit for this parameter) flashes.

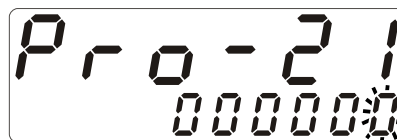

Saving Count Value (Power down back-up)

You can change the parameter with INCREMENT button, save it to the memory and pass to the next parameter with ENTER button.

Press PROG button to exit from programming section without doing any changes.

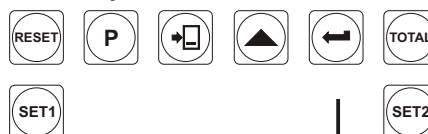

Press ENTER button

The most significant digit of the parameter (1st digit for this parameter) flashes.

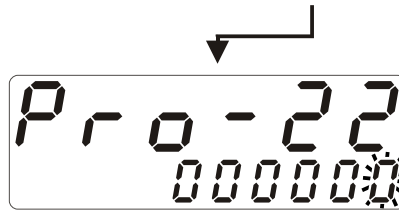

SET1 Operation Form Selection

You can change the parameter with INCREMENT button, save it to the memory and pass to the next parameter with ENTER button.

Press PROG button to exit from programming section without doing any changes.

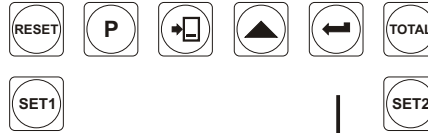

Press ENTER button

The most significant digit of the parameter (3rd digit for this parameter) flashes.



Communication Accessing Address

You can change the parameter with INCREMENT button, save it to the memory and pass to the next parameter with ENTER button.

Press PROG button to exit from programming section without doing any changes.

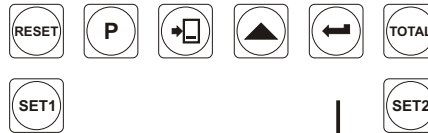

Press ENTER button

The most significant digit of the parameter (1st digit for this parameter) flashes.



Modbus Protocol Type Selection

You can change the parameter with INCREMENT button, save it to the memory and pass to the next parameter with ENTER button.

Press PROG button to exit from programming section without doing any changes.



Press ENTER button

The most significant digit of the parameter (1st digit for this parameter) flashes.



Parity Selection

You can change the parameter with INCREMENT button, save it to the memory and pass to the next parameter with ENTER button.

Press PROG button to exit from programming section without doing any changes.



Press ENTER button

The most significant digit of the parameter (1st digit for this parameter) flashes.

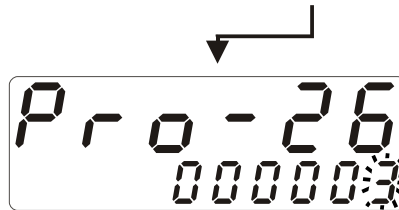

Baud Rate

You can change the parameter with INCREMENT button, save it to the memory and pass to the next parameter with ENTER button.

Press PROG button to exit from programming section without doing any changes.

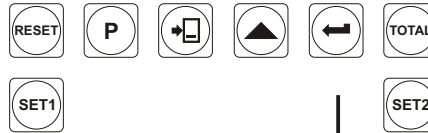

Press ENTER button

The most significant digit of the parameter (1st digit for this parameter) flashes.



Stop Bit Selection

You can change the parameter with INCREMENT button, save it to the memory and pass to the next parameter with ENTER button.

Press PROG button to exit from programming section without doing any changes.

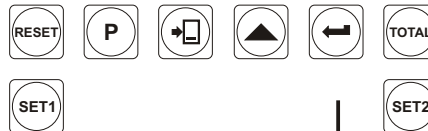

Press ENTER button

The most significant digit of the parameter (1st digit for this parameter) flashes.



Reset and Set Protection

You can change the parameter with INCREMENT button, save it to the memory and pass to the next parameter with ENTER button.

Press PROG button to exit from programming section without doing any changes.



Press ENTER button

The most significant digit of the parameter (6th digit for this parameter) flashes.



Multiplication Coefficient

You can change the parameter with INCREMENT button, save it to the memory and pass to the next parameter with ENTER button.

Press PROG button to exit from programming section without doing any changes.

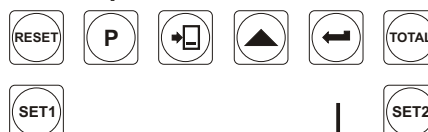

Press ENTER button

When **PSuurd** password screen is shown if ENTER button is pressed without entering the password this parameter can not be observed.

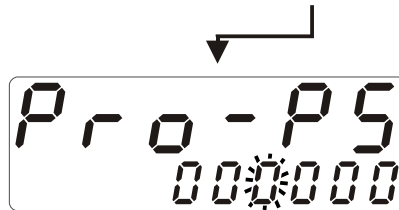

Program Password

User can change the parameter with INCREMENT button, save it to the memory and pass to the next parameter with ENTER button.

The most significant digit of the parameter (4th digit for this parameter) flashes.

Press PROG button to exit from programming section without doing any changes.

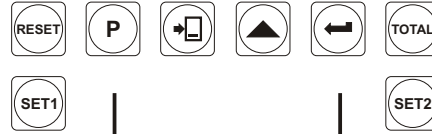

Continue to press ENTER button for scanning all parameters.

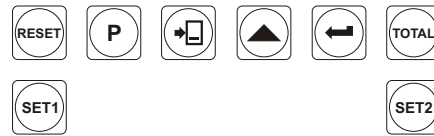
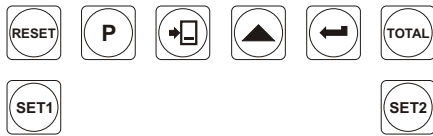
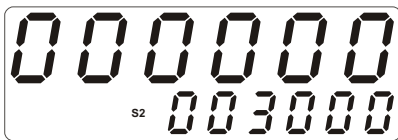

Operation Screen

Input Types and Functions

8. Program Parameters

Pro-01

Input Types and Functions
(It is accessible in COUNTER / "TOTALIZER COUNTER" and BATCH COUNTER functions)

000000 Upcount on rising edge of Ch-A input

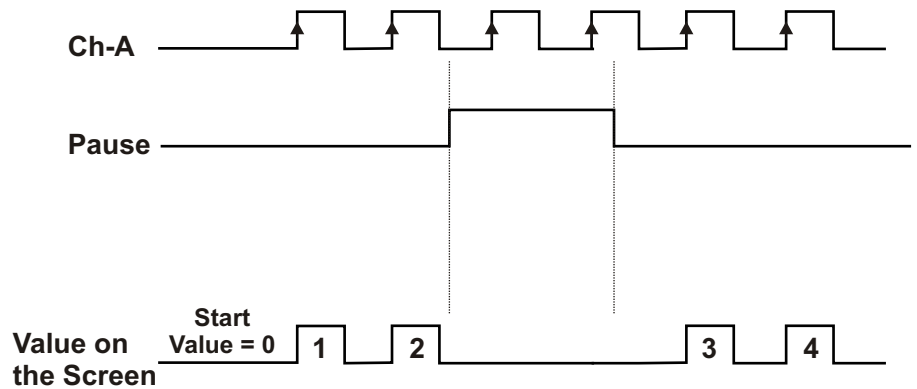

000001 Downcount on rising edge of Ch-A input.

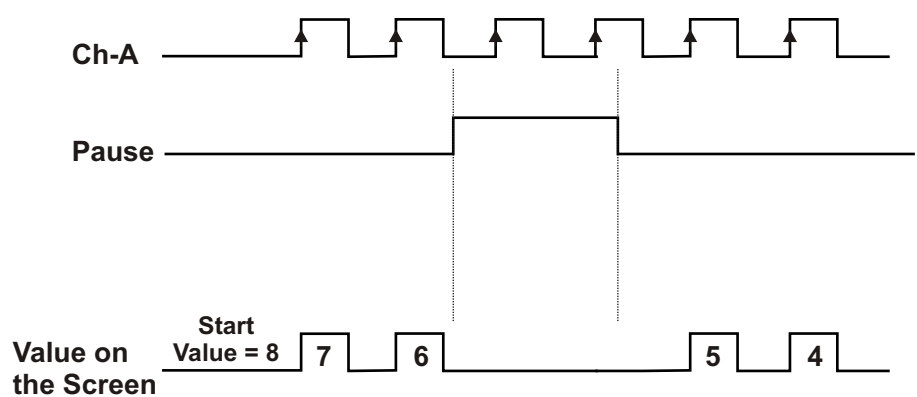

000002 Upcount on rising edge of Ch-A input.
Downcount on rising edge of Ch-B input.

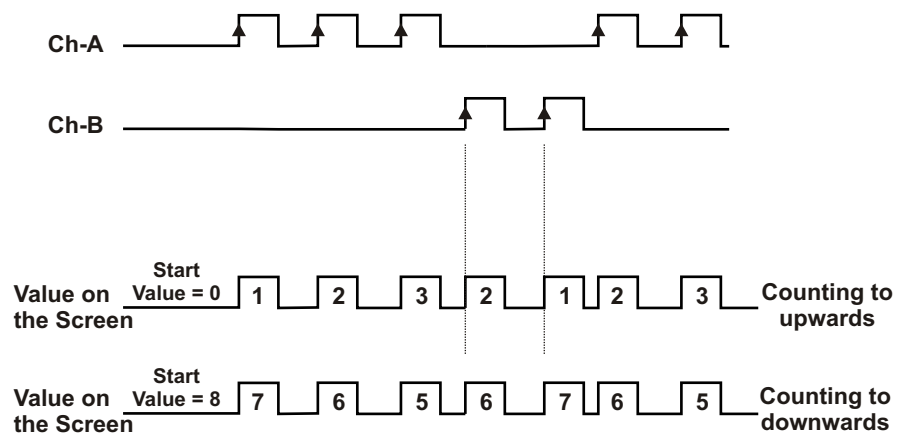

000003

Upcount on rising edge of Ch-A input
Upcount on rising edge of Ch-B input

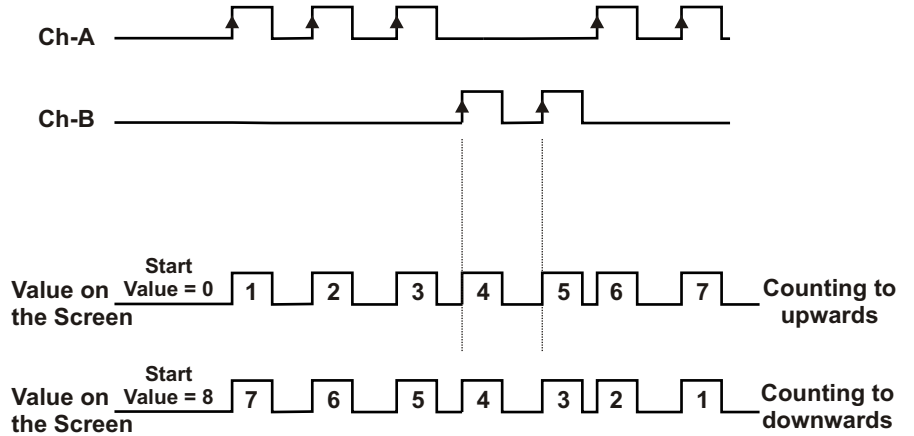

000004

Upcount on rising edge of Ch-A input when Ch-B is at 0
Downcount on rising edge of Ch-A when Ch-B is at 1

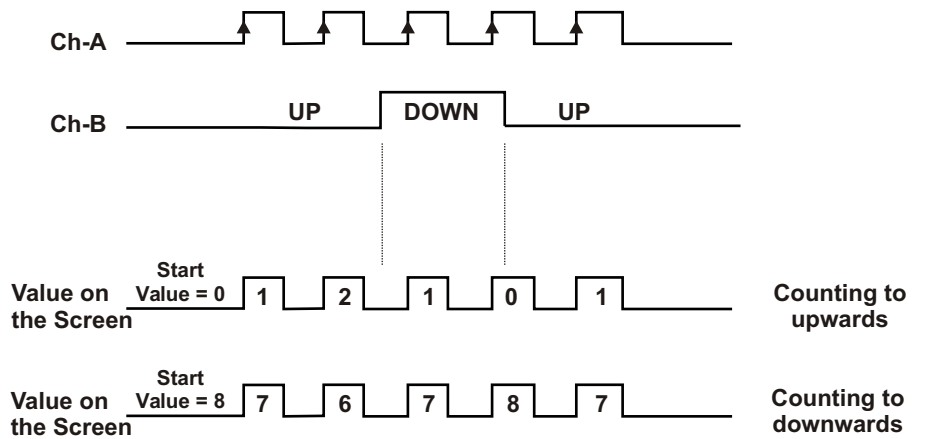

000005

x1 Phase Shifting (for incremental encoders)
Upcount on rising edge of Ch-A input when Ch-B is at 0
Downcount on falling edge of Ch-A input when Ch-B is at 0

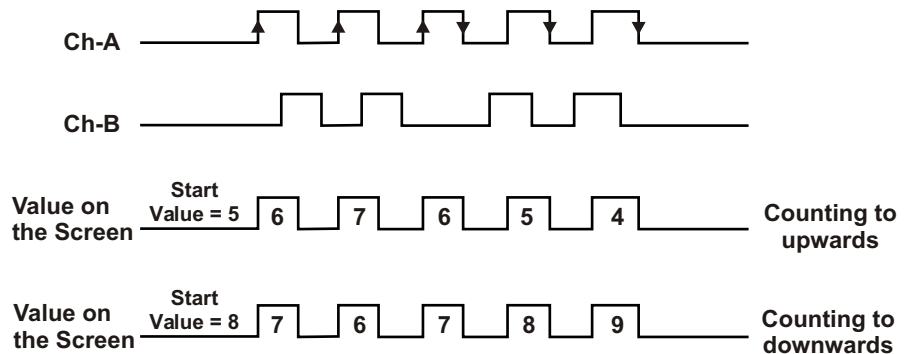

If `Pro-01` is `000005`, `Pro-04` must be `000000`. If not counting is not performed.

000006

x2 Phase Shifting (for incremental encoders)

Upcount on rising edge of Ch-A when Ch-B is at 0

Downcount on falling edge of Ch-A when Ch-B is at 0

Downcount on rising edge of Ch-A when Ch-B is at 1

Upcount on falling edge of Ch-A when Ch-B is at 1

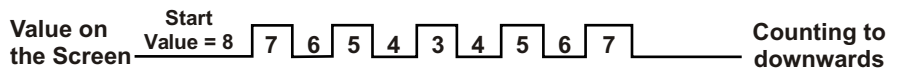
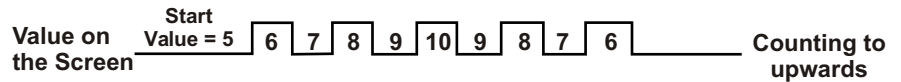
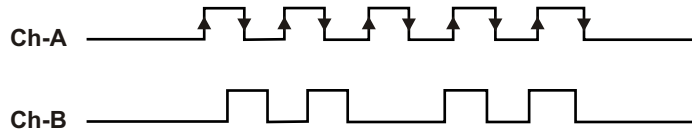

If `Pr0-01` is `000006`, `Pr0-04` must be `000000`. If not counting is not performed.

000007

x4 Phase Shifting (for incremental encoders)

Upcount on rising edge of Ch-A when Ch-B is at 0

Downcount on falling edge of Ch-A when Ch-B is at 0

Downcount on rising edge of Ch-A when Ch-B is at 1

Upcount on falling edge of Ch-A when Ch-B is at 1

Downcount on rising edge of Ch-B when Ch-A is at 0

Upcount on falling edge of Ch-B when Ch-A is at 0

Upcount on rising edge of Ch-B when Ch-A is at 1

Downcount on falling edge of Ch-B when Ch-A is at 1

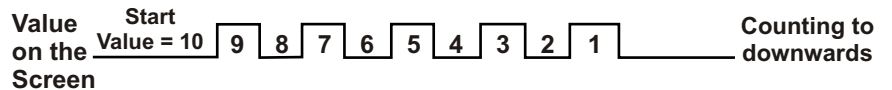
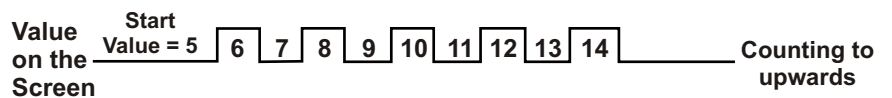
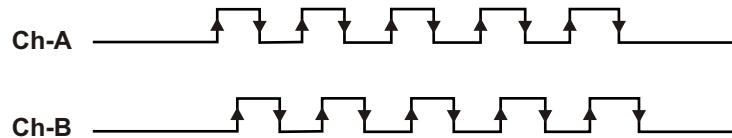

If `Pr0-01` is `000007`, `Pr0-04` must be `000000`. If not counting is not performed.

Pro-02

Selection of Input Type Function for Chronometer (It is accessible only in CHRONOMETER function)

000000

Period measurement in Ch-A input.

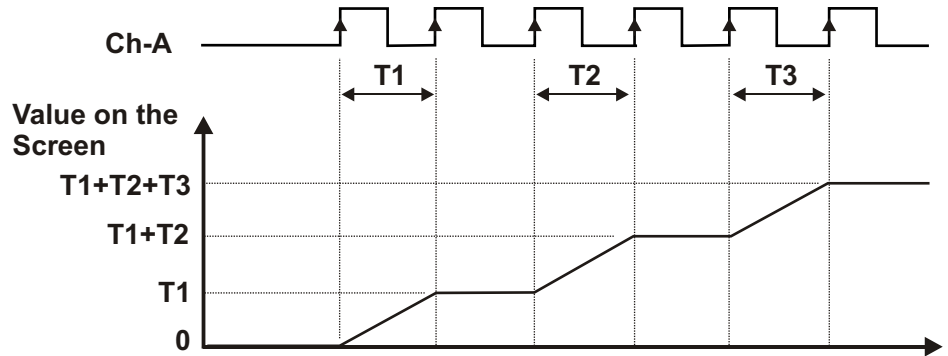

000001

Pulse time measurement in Ch-A input.

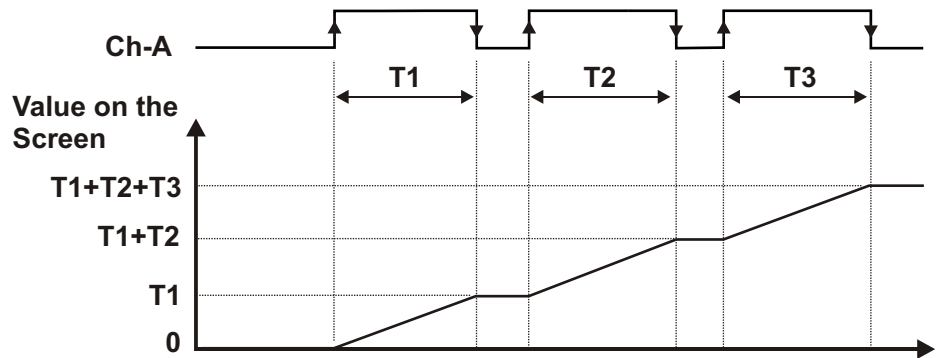

000002

Sum of the time difference between Ch-A and Ch-B inputs rising edges

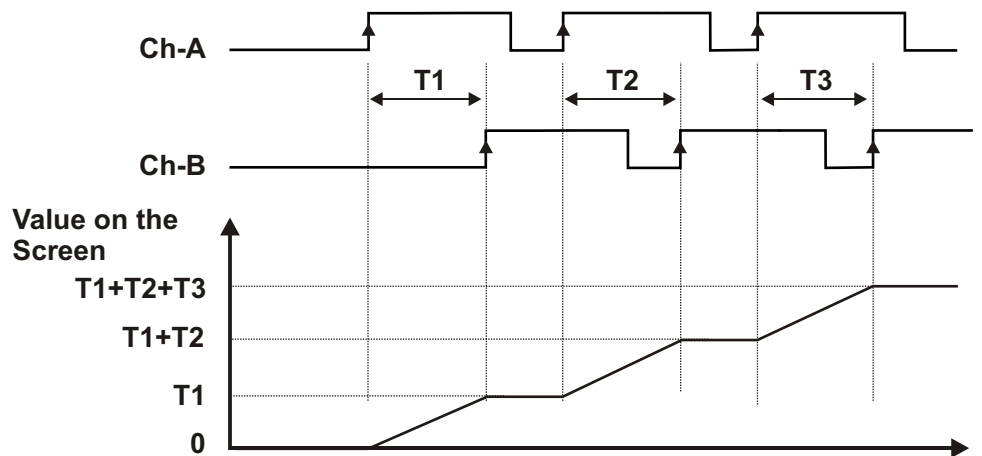

Input type function selection parameter **Pro-02** for chronometer is performed according to the time range is set in Time Unit and Scale selection parameter **Pro-05**

Pr0-03

Selection of Measuring Method

(It is accessible only in FREQUENCYMETER / TACHOMETER Function)

000000

Frequency or cycle is calculated by measuring cycle time of the signals in Ch-A input

000001

Frequency or cycle is calculated by counting the pulses in Ch-A input during the time is set in measurement period parameter Pr0-08



For details on these methods, refer to Section 7.8.1“Examples About Frequency/Tachometer Function Applications”

Only Ch-A input performs in Frequency/Tachometer function.

Pr0-04

Pulse Time of Ch-A, Ch-B, Reset and Pause Input

(It is accessible in functions except for TIMER function)

It is used to protect against the electrical contact debounce or the signal that is less than the determined pulse time.

It can be adjusted from 000000 to 000250 msec. If it's adjusted to 000000 then there is no time protection for Ch-A and Ch-B. If the parameter value is adjusted 000000 or 000001 then Reset and Pause protection times are accepted as 2 msec.



If Input Types and Functions parameter Pr0-01 is 000005, 000006 or 000007 then pulse time of Ch-A and Ch-B parameter Pr0-04 must be 000000. If not counting is not performed.

Pr0-05

Selection of Time Unit and Scale

(It is accessible in TIMER and CHRONOMETER functions)

000000

Hour / Minute

It can be adjusted from 000000 to 009959

000001

Minute / Second

It can be adjusted from 000000 to 009959

000002

Second / Millisecond

It can be adjusted from 000000 to 009999

000003

Hour / Minute

It can be adjusted from 000000 to 002359

000004

Hour

It can be adjusted from 000000 to 999999

000005

Minute

It can be adjusted from 000000 to 999999

000006

Second

It can be adjusted from 000000 to 999999



After adjustment of Time Range parameter $Pr0-05$, if SET1 and SET2 values are not appropriate for this selection, SET1 and SET2 are changed according to this selection. (E.g. If time range is 99.99 and SET1 is 45.94, there is no problem. If time range is 99.59 and SET1 is 45.94, then SET1 is changed as 45.59)

Pr0-06

Output Functions

(It is accessible in functions except for FREQUENCYMETER / TACHOMETER function)

This parameter can be adjusted from 000000 to 000001 in Batch Counter function and operates different from the other functions.

Pr0-06

000000

Manual Reset-1.

Device continues to count till manual reset is applied.

Output-2 pulse time $Pr0-17$ is not considered.

How it operates in COUNTER / "TOTALIZER COUNTER", TIMER and CHRONOMETER function is explained below:

Counting direction : 0 P (Upcount)

$Pr0-19 = 000000$

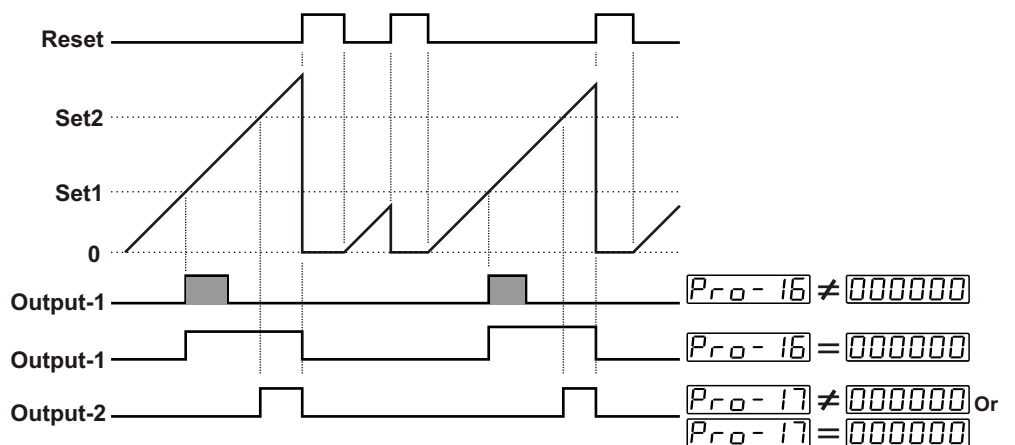

When count value reaches to SET1 value, Output-1 becomes active. If Output-1 pulse time $Pr0-16$ is 000000, Output-1 does not change condition until manual reset input is active. If Output-1 pulse time $Pr0-16$ is not 0, at the end of the pulse time Output-1 becomes inactive. When count value reaches to SET2 value, Output-2 becomes active. Counting continues over SET2 value. Output-2 pulse time $Pr0-17$ is not considered.

Count value is added to total count value when manual reset is active in COUNTER / "TOTALIZER COUNTER" functions.

How it operates in COUNTER / "TOTALIZER COUNTER", TIMER and CHRONOMETER functions is explained below:

Counting direction : P 0 (Downcount) $Pr0-19 = 000001$

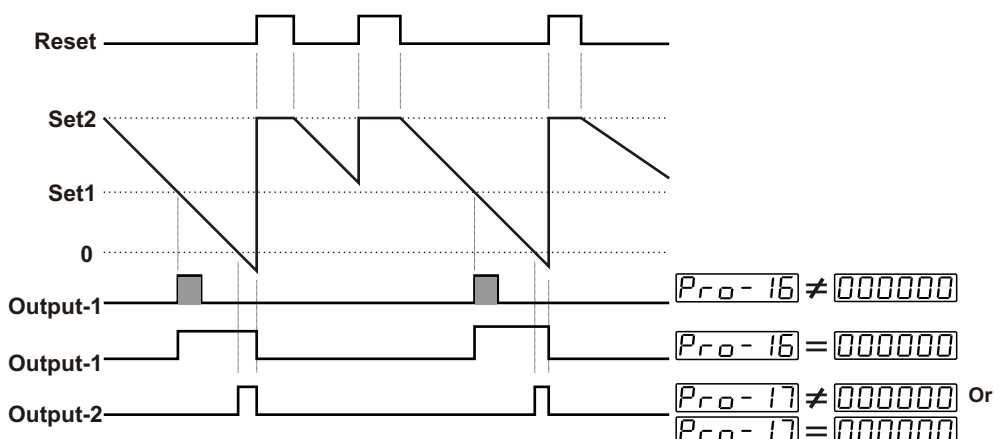

When the count value reaches to SET1 value, Output-1 becomes active. If Output-1 Pulse Time $Pr0-16$ is 000000 , Output-1 does not change condition until manual reset input is active. If Output-1 pulse time $Pr0-16$ is not 0, Output-1 becomes inactive at the end of the pulse time. When actual value reaches to 000000 , Output-2 becomes active. Counting continues under 000000 Output-2 pulse time $Pr0-17$ is not considered.

Count value is added to total count value when manual reset is active in COUNTER / "TOTALIZER COUNTER" functions.

$Pr0-06$ 000001 Manual Reset-2.
 (Output-2 Pulse Time $Pr0-17$ is not considered)

How it operates in COUNTER / "TOTALIZER COUNTER", TIMER and CHRONOMETER functions is explained below:

Counting direction : 0 P (Upcount) $Pr0-19 = 000000$

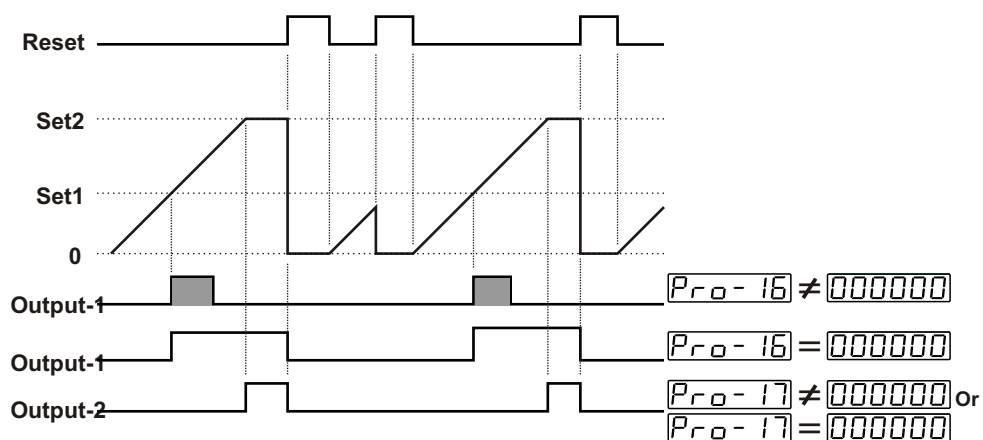

When the count value reaches to SET1 value, Output-1 becomes active. If Output-1 pulse time Pr_0-16 is 000000 , Output-1 does not change position until manual reset input is active. If Output-1 pulse time Pr_0-16 is not 0, Output-1 becomes inactive at the end of the pulse time.

When the count value reaches to SET2 value, Output-2 becomes active. Counting does not continue over SET2 value. For starting to count manual reset input must be active. Output-2 Pulse Time Pr_0-17 is not considered.

Count value is added to total count value when manual reset is active in COUNTER / "TOTALIZER COUNTER" functions.

How it operates in COUNTER / "TOTALIZER COUNTER", TIMER and CHRONOMETER functions is explained below:

Counting direction : P 0 (Downcount) $Pr_0-19 = 000001$

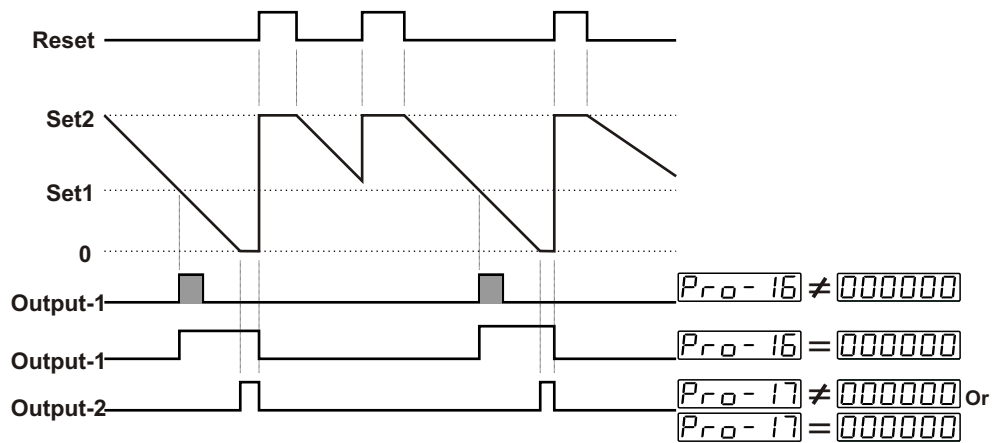

When the count value reaches to SET1 value, Output-1 becomes active. If Output-1 pulse time Pr_0-16 is 000000 , Output-1 does not change condition until manual reset input is active. If Output-1 pulse time Pr_0-16 is not 0, Output-1 becomes inactive at the end of the pulse time.

When the count value reaches to 000000 value, Output-2 becomes active. Counting does not continue under 000000 . For starting to count manual reset input must be active. Output-2 pulse time Pr_0-17 is not considered.

Count value is added to total count value when manual reset is active in COUNTER / "TOTALIZER COUNTER" functions.

Pro-06

000002

Manual Reset-3.

Counting continues until Manual Reset input is active.
(Output-2 Pulse Time **Pro-17** is considered)

How it operates in COUNTER / "TOTALIZER COUNTER", TIMER and CHRONOMETER functions is explained below:

Counting direction : 0 P (Upcount) **Pro-19** = 000000

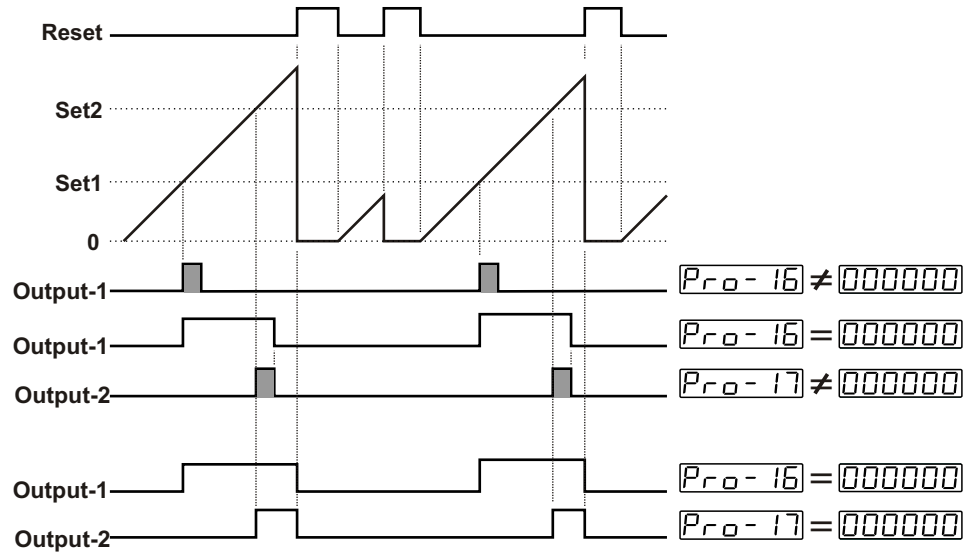

When the count value reaches to SET1 value, Output-1 becomes active. If Output-1 Pulse Time **Pro-16** is not 0, Output-1 changes position at the end of the pulse time. If Output-1 Pulse Time **Pro-16** is 000000, it changes position until Manual Reset input is active or according to Output-2.

When the count value reaches to SET2 value, Output-2 becomes active. Counting continues until manual reset input is active. If Output-2 Pulse Time **Pro-17** is not 0, Output-2 changes position at the end of the pulse time. In this case, if Output-1 is active, it becomes inactive with Output-2.

Count value is added to total count value when manual reset is active in COUNTER / "TOTALIZER COUNTER" functions.

How it operates in COUNTER / “TOTALIZER COUNTER”, TIMER and CHRONOMETER function is explained below:

Counting direction : P 0 (Downcount) $Pr0-19 = 000001$

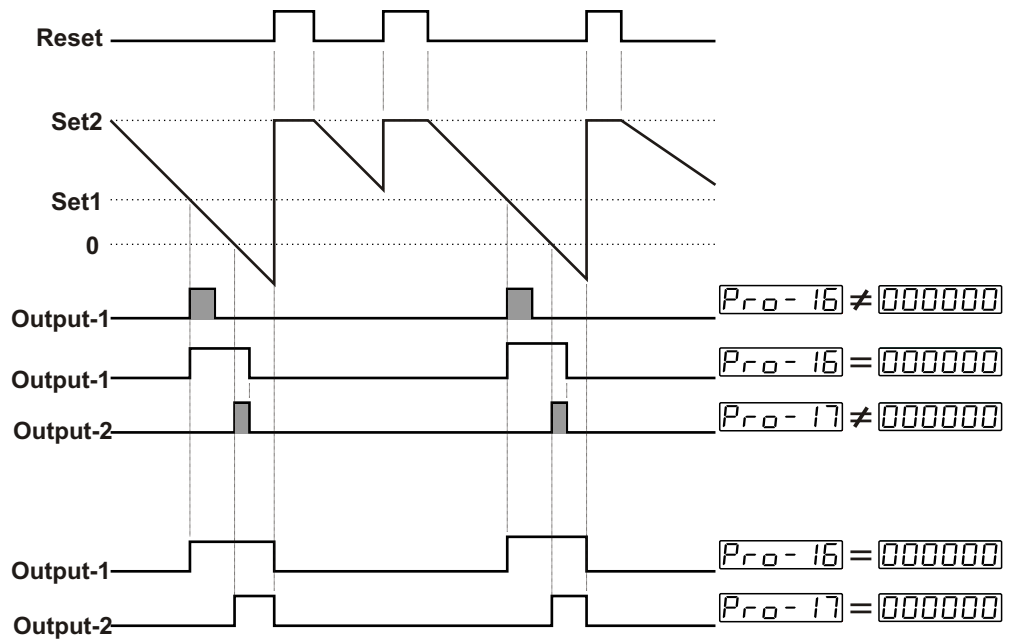

When the count value reaches to SET1 value, Output-1 becomes active. If Output-1 pulse time $Pr0-16$ is not 0, Output-1 changes position at the end of the pulse time. If Output-1 Pulse Time $Pr0-16$ is 000000 it changes position until Manual Reset input is active or according to Output-2.

When count value reaches to 000000 value, Output-2 becomes active. Counting continues until manual reset input is active. If Output-2 Pulse time $Pr0-17$ is not 0, Output-2 changes position at the end of the pulse time. In this case, if Output-1 is active, it becomes inactive with Output-2.

Count value is added to total count value when manual reset is active in COUNTER / “TOTALIZER COUNTER” functions.

Pro-06

000003

Automatic Reset-1

How it operates in COUNTER / "TOTALIZER COUNTER", TIMER and CHRONOMETER functions is explained below:

Counting direction : 0 P (Upcount) Pro-19 = 000000

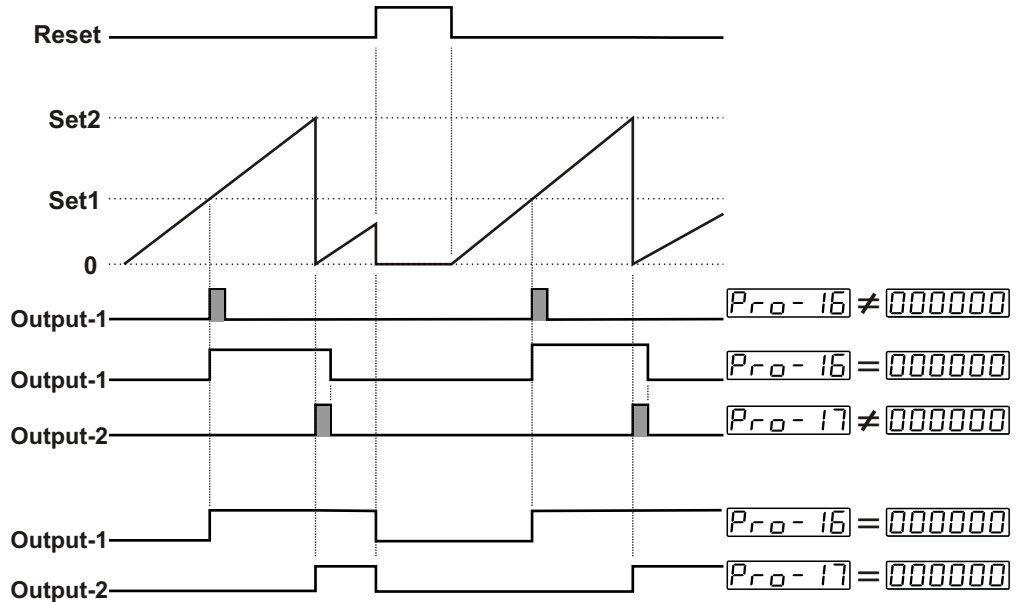

When the count value reaches to SET1 value, Output-1 becomes active. If Output-1 pulse time Pro-16 is not 0, Output-1 changes position at the end of the pulse time. If Output-1 Pulse Time Pro-16 is 000000, it changes position until Manual Reset input is active or according to Output-2 position.

When the count value reaches to SET2 value, Output-2 becomes active. Count value is reset. If Output-2 pulse time Pro-17 is not 0, Output-2 changes position at the end of the pulse time. In this case, if Output-1 is active, it becomes inactive with Output-2.

Count value is added to total count value when automatic reset is active in COUNTER / "TOTALIZER COUNTER" functions.



If output functions parameter Pro-06 is selected Automatic Reset (000003, 000004, 000005 or 000006), then Pro-17 must be different from zero. If not Automatic Reset is not realised.

How it operates in COUNTER / “TOTALIZER COUNTER”, TIMER and CHRONOMETER function is explained below:

Counting Direction : P 0 (Downcount) $Pr_0-19 = 000001$

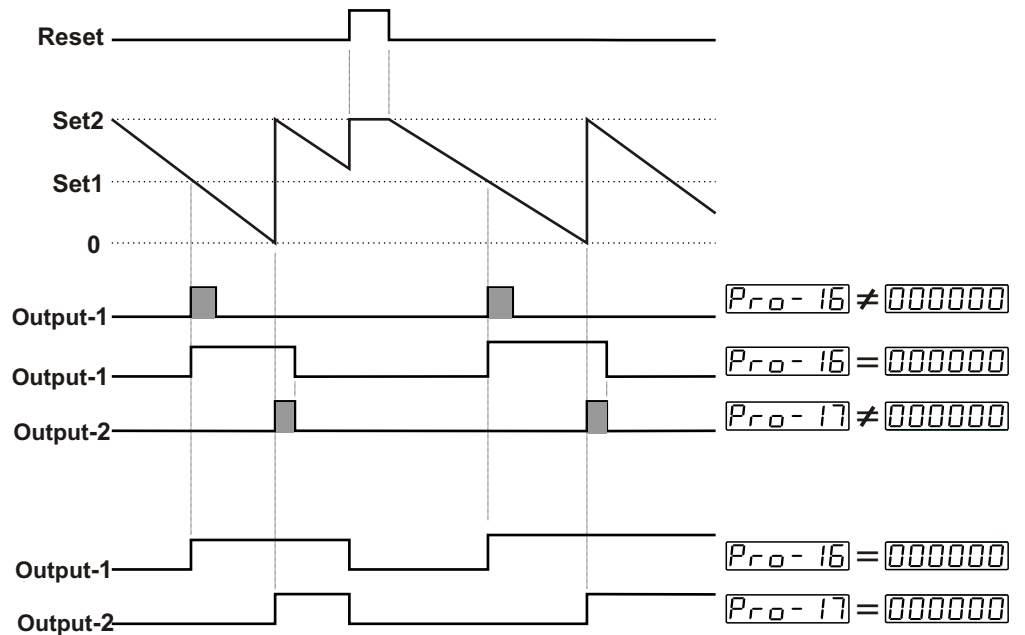

When the count value reaches to SET1 value, Output-1 becomes active. If Output-1 pulse time Pr_0-16 is not 0, Output-1 changes position at the end of the pulse time. If Output-1 Pulse Time Pr_0-16 is 000000 it changes position until Manual Reset input is active or according to Output-2 position.

When the count value reaches to 000000 value, Output-2 becomes active. Count value becomes equal to Set-2 value and counting is started again. If Output-2 pulse time Pr_0-17 is not 0, Output-2 changes position at the end of the pulse time. In this case, if Output-1 is active, it becomes inactive with Output-2.

Count value is added to total count value when automatic reset is active in COUNTER / “TOTALIZER COUNTER” functions.



If output functions parameter Pr_0-06 is selected Automatic Reset (000003 , 000004 , 000005 or 000006), then Pr_0-17 must be different from zero. If not Automatic Reset is not realized.

Pro-06

000004

Automatic Reset-2

How it operates in COUNTER / "TOTALIZER COUNTER", TIMER and CHRONOMETER function is explained below:

Counting direction : 0 P (Upcount) Pro-19 = 000000

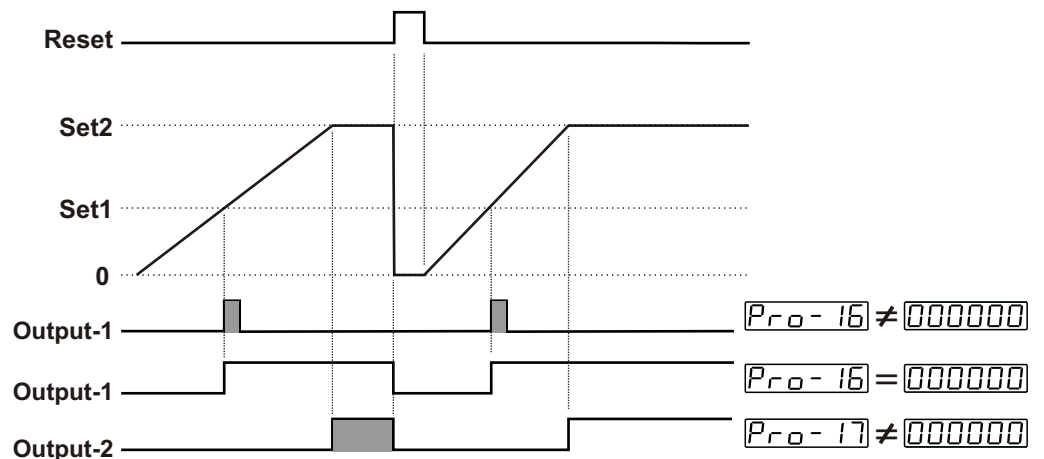
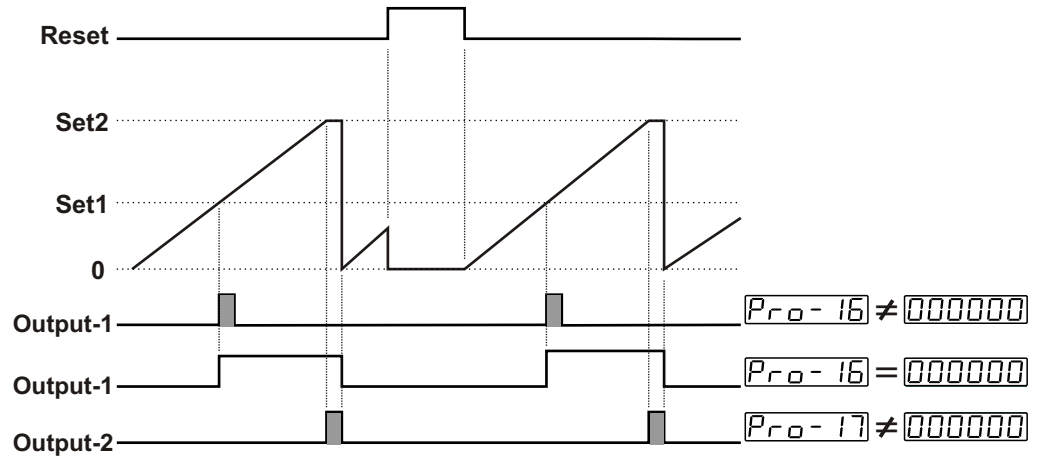

When the count value reaches to SET1, Output-1 becomes active. If Output-1 pulse time Pro-16 is not 0, Output-1 changes position at the end of the pulse time. If Output-1 Pulse Time Pro-16 is 000000, it changes position until Manual Reset input is active or according to Output-2 position.

When the count value reaches to SET2, Output-2 becomes active. Counting is stopped. If Output-2 pulse time Pro-17 is not 0, count value is reset and Output-2 becomes inactive at the end of the pulse time. In this case, if Output-1 is active, it becomes inactive with Output-2.

Count value is added to total count value when automatic reset is active in COUNTER / "TOTALIZER COUNTER" functions.



If output functions parameter Pro-06 is selected Automatic Reset (000003, 000004, 000005 or 000006), then Pro-17 must be different from zero. If not, Automatic Reset is not realised.

How it operates in COUNTER / “TOTALIZER COUNTER”, TIMER and CHRONOMETER functions are explained below:

Counting direction : P 0 (Downcount) $Pr0-19 = 000001$

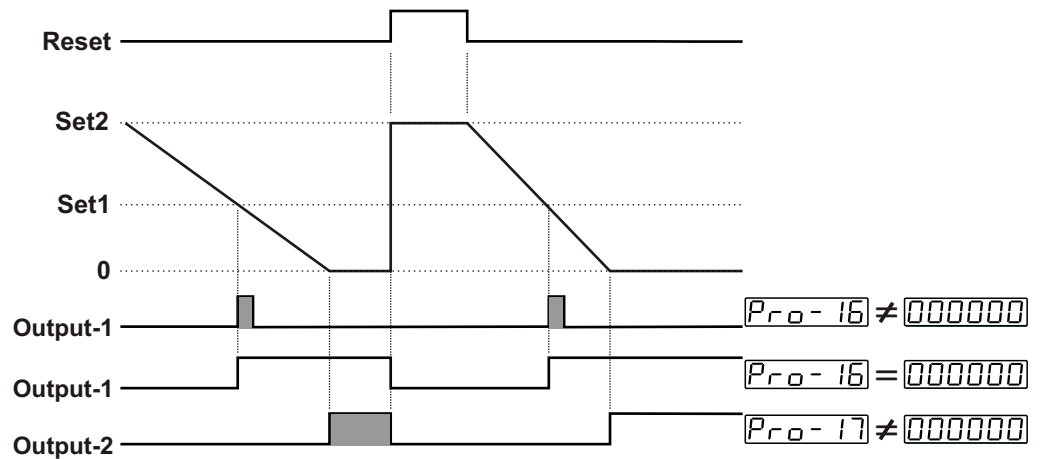
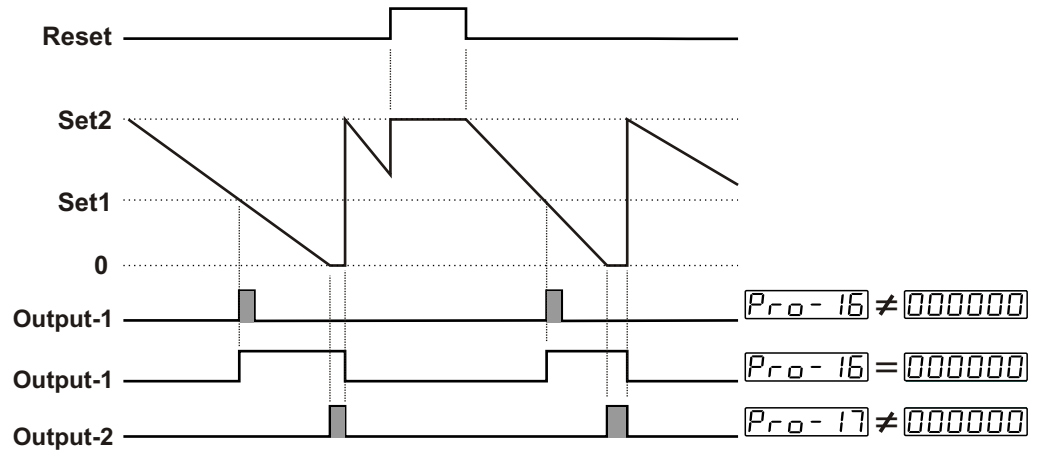

When the count value reaches to SET1, Output-1 becomes active. If Output-1 pulse time $Pr0-16$ is not 0, Output-1 changes position at the end of the pulse time. If Output-1 Pulse Time $Pr0-16$ is 000000, it changes position until Manual Reset input is active or according to Output-2 position.

When the count value reaches to 000000 value, Output-2 becomes active. Counting is stopped. If Output-2 pulse time $Pr0-17$ is not 0, count value becomes equal to SET2 value, counting is started again and Output-2 becomes inactive. In this case, if Output-1 is active, it becomes inactive with Output-2.

Count value is added to total count value when automatic reset is active in COUNTER/“TOTALIZER COUNTER” functions.



If output functions parameter $Pr0-06$ is selected Automatic Reset (000003, 000004, 000005 or 000006), then $Pr0-17$ must be different from zero. If not, Automatic Reset is not realised.

Pro-06

000005

Automatic Reset-3

How it operates in COUNTER / “TOTALIZER COUNTER”, TIMER and CHRONOMETER functions are explained below:

Counting direction : 0 P (Upcount)

Pro-19 = 000000

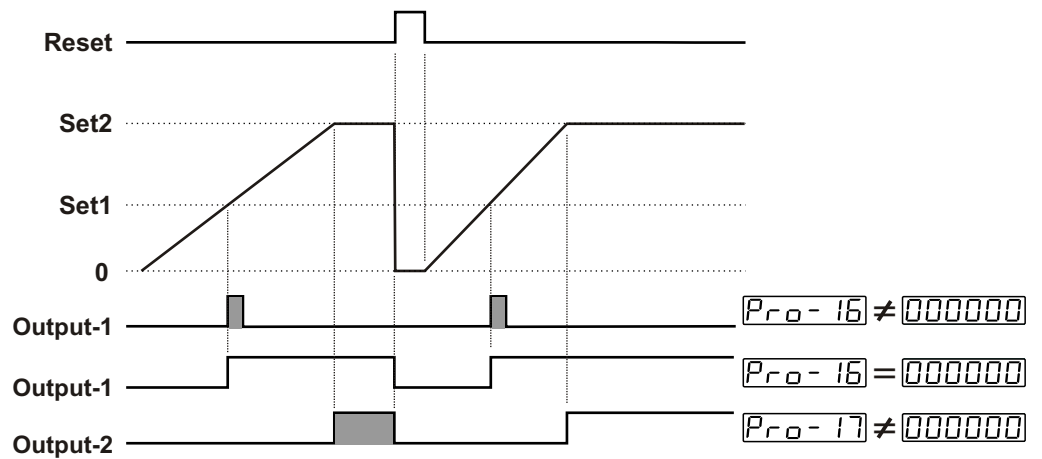
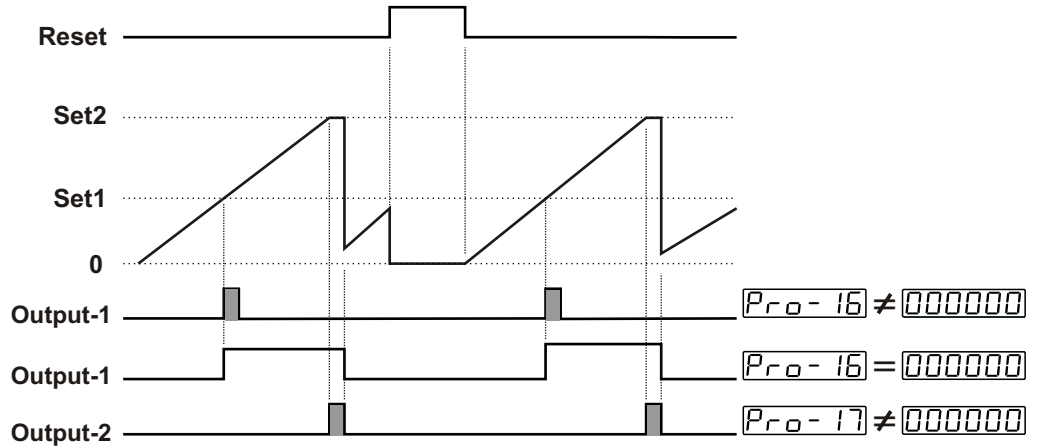

When the count value reaches to SET1, Output-1 becomes active. If Output-1 pulse time $Pro-16$ is not 0, Output-1 changes position at the end of the pulse time. If Output-1 Pulse Time $Pro-16$ is 000000, it changes position until Manual Reset input is active or according to Output-2 position.

When the count value reaches to SET2, Output-2 becomes active and count value is reset.

When the count value reaches to SET2, Output-2 becomes active and count value is reset. But SET2 value is observed in actual value display. If Output-2 pulse time $Pro-17$ is not 0, count value is observed in actual value display and Output-2 becomes inactive. In this case, if Output-1 is active, it becomes inactive with Output-2.

Count value is added to total count value when automatic reset is active in COUNTER / “TOTALIZER COUNTER” functions.



If output functions parameter $Pro-06$ is Automatic Reset (000003, 000004, 000005 or 000006), then $Pro-17$ must be different from zero. If not, Automatic Reset is not realised.

How it operates in COUNTER / “TOTALIZER COUNTER”, TIMER and CHRONOMETER functions are explained below:

Counting Direction : P 0 (Downcount) $Pr0-19 = 000001$

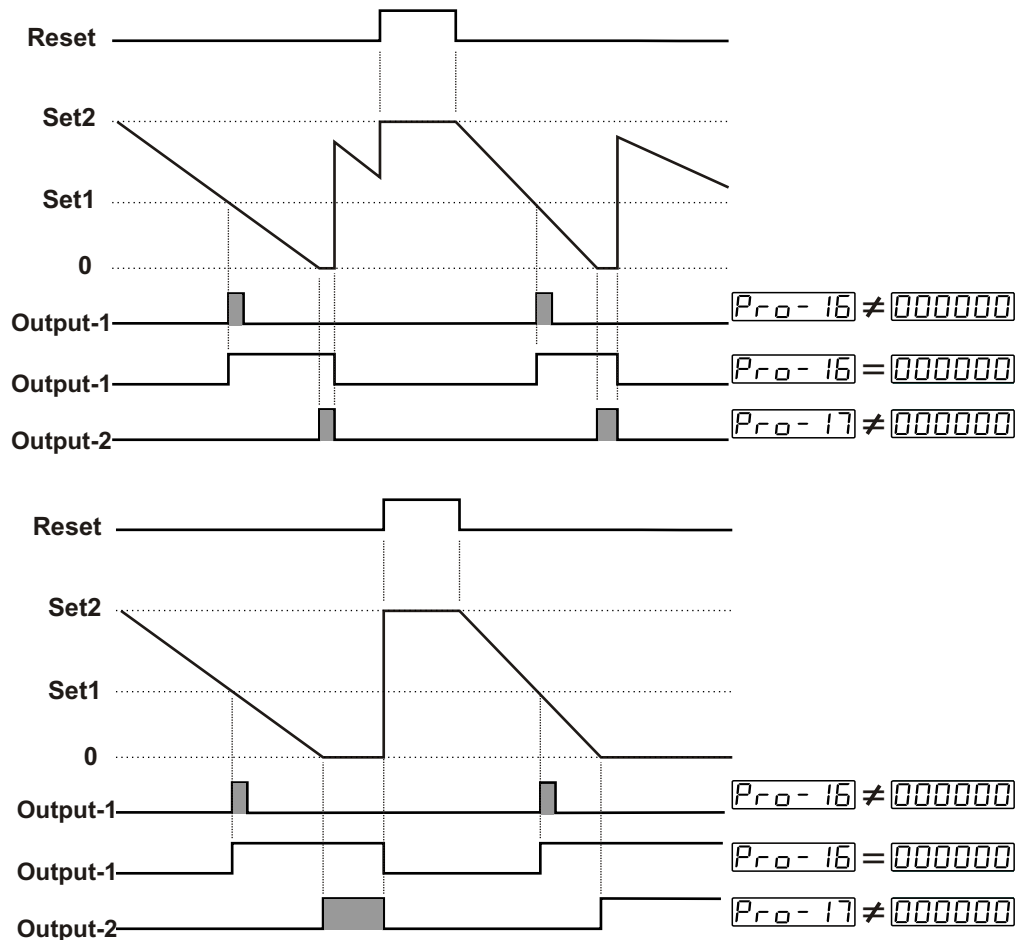

When the count value reaches to SET1, Output-1 becomes active. If Output-1 pulse time $Pr0-16$ is not 0, Output-1 changes position at the end of the pulse time. If Output-1 Pulse Time $Pr0-16$ is 000000, it changes position until Manual Reset input is active or according to Output-2 position.

When the count value reaches to 000000 value, Output-2 becomes active, count value becomes equal to SET2 and counting continues. But 000000 observed in actual value display. If Output-2 pulse time $Pr0-17$ is not 0, count value is observed in actual value screen and Output-2 becomes inactive at the end of the pulse time. In this case, if Output-1 is active, it becomes inactive with Output-2.

Count value is added to total count value when automatic reset is active in COUNTER / “TOTALIZER COUNTER” functions.



If output functions parameter $Pr0-06$ is selected Automatic Reset (000003, 000004, 000005 or 000006), then $Pr0-17$ must be different from zero. If not, Automatic Reset is not realised.

Pro-06

000006

Automatic Reset-4

How it operates in COUNTER / "TOTALIZER COUNTER", TIMER and CHRONOMETER functions are explained below:

Counting direction : 0 P (Upcount) Pro-19 = 000000

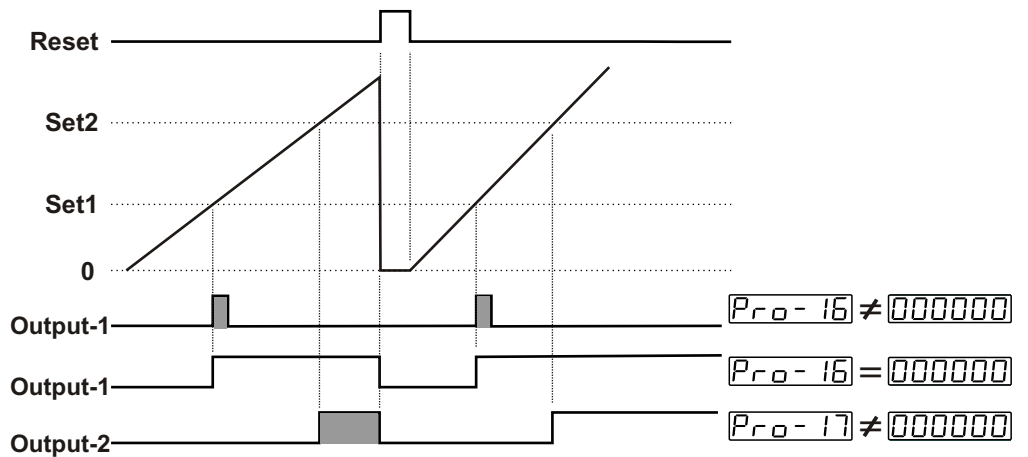
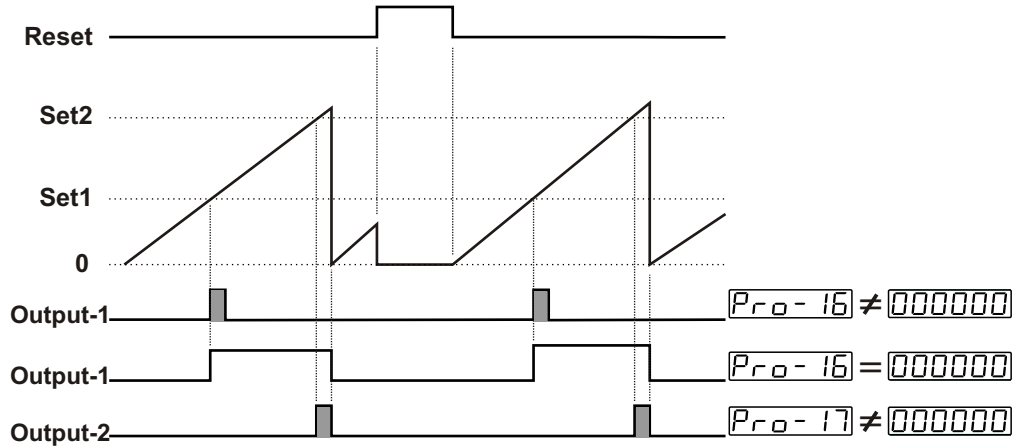

When the count value reaches to SET1, Output-1 becomes active. If Output-1 pulse time Pro-16 is not 0, Output-1 changes position at the end of the pulse time. If Output-1 Pulse Time Pro-16 is 000000, it changes position until Manual Reset input is active or according to Output-2 position.

When the count value reaches to SET2, Output-2 becomes active and counting continues over 0. If Output-2 pulse time Pro-17 is not 0, count value is reset and Output-2 becomes inactive at the end of the pulse time. In this case, if Output-1 is active, it becomes inactive with Output-2.

Count value is added to total count value when automatic reset is active in COUNTER / "TOTALIZER COUNTER" functions.



If output functions parameter Pro-06 is selected Automatic Reset (000003, 000004, 000005 or 000006), then Pro-17 must be different from zero. If not, Automatic Reset is not realised.

How it operates in COUNTER / “TOTALIZER COUNTER”, TIMER and CHRONOMETER functions are explained below:

Counting Direction : P 0 (Downcount) $Pr0-19 = 000001$

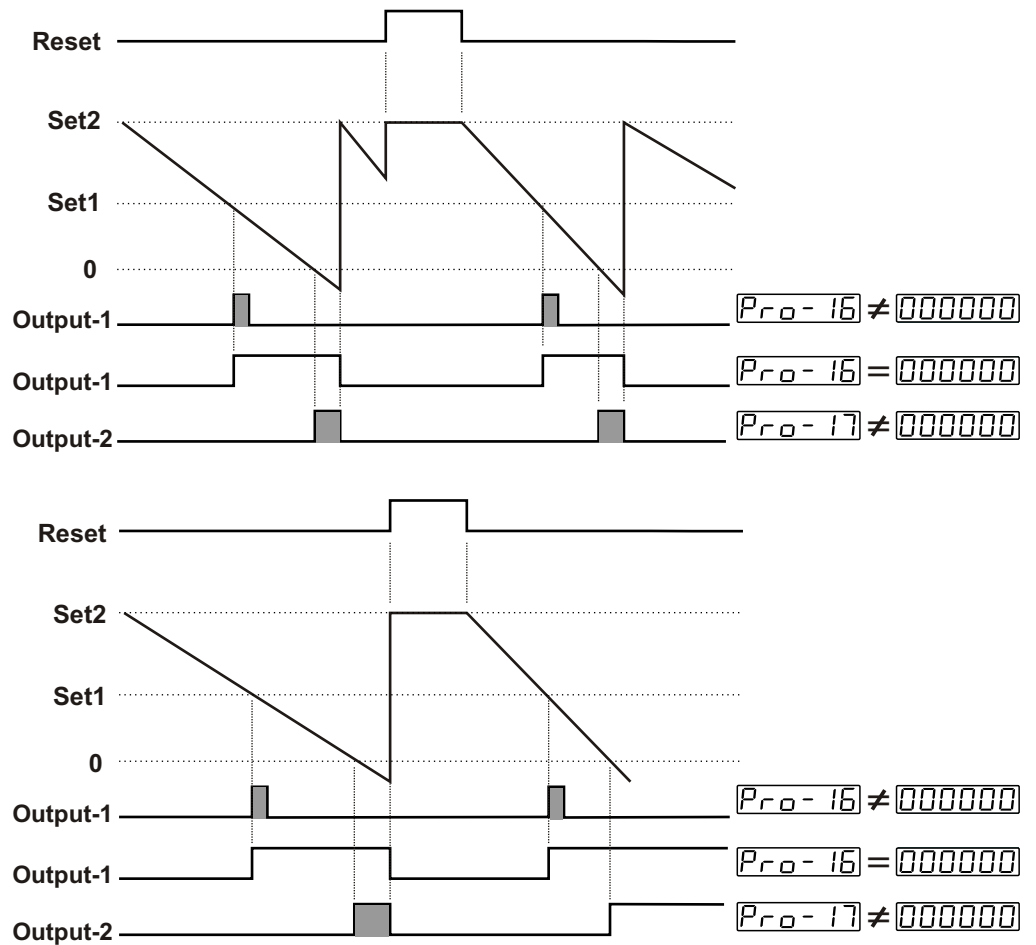

When the count value reaches to SET1, Output-1 becomes active. If Output-1 pulse time $Pr0-16$ is not 0, Output-1 changes position at the end of the pulse time. If Output-1 Pulse Time $Pr0-16$ is 000000, it changes position until Manual Reset input is active or according to Output-2 position.

When count value reaches to 000000 value, Output-2 becomes active and counting continues under 0. If Output-2 pulse $Pr0-17$ time is not 0, count value becomes equal to SET2 and Output-2 becomes inactive. In this case, if Output-1 is active, it becomes inactive with Output-2.

Count value is added to total count value when automatic reset is active in COUNTER / “TOTALIZER COUNTER” functions.



If output functions parameter $Pr0-06$ is selected Automatic Reset (000003, 000004, 000005 or 000006), then $Pr0-17$ must be different from zero. If not, Automatic Reset is not realised.

Pr0-06

000007

Automatic Reset-5

Pulse times Pr0-16 and Pr0-17 is not considered.

How it operates in COUNTER / "TOTALIZER COUNTER" functions are explained below:

Counting direction : 0 P (Upcount) Pr0-19 = 000000

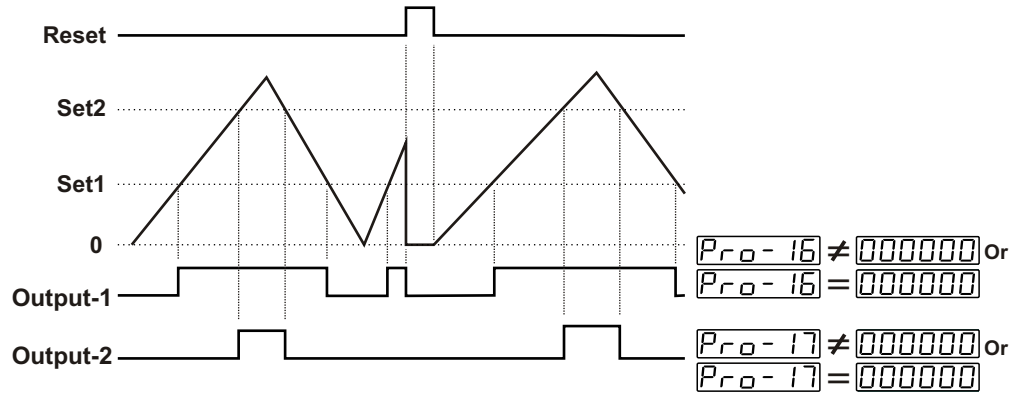

If count value is equal or greater than SET1 value, then Output-1 becomes active. Output-1 pulse time Pr0-16 is not considered. If count value is equal or greater than SET2 value, then Output-2 becomes active. If count value is less than SET2 value, Output-2 becomes inactive. Output-2 pulse time Pr0-17 is not considered.

Count value is added to total count value when Manual Reset is performed.

Counting direction : P 0 (Downcount) Pr0-19 = 000001

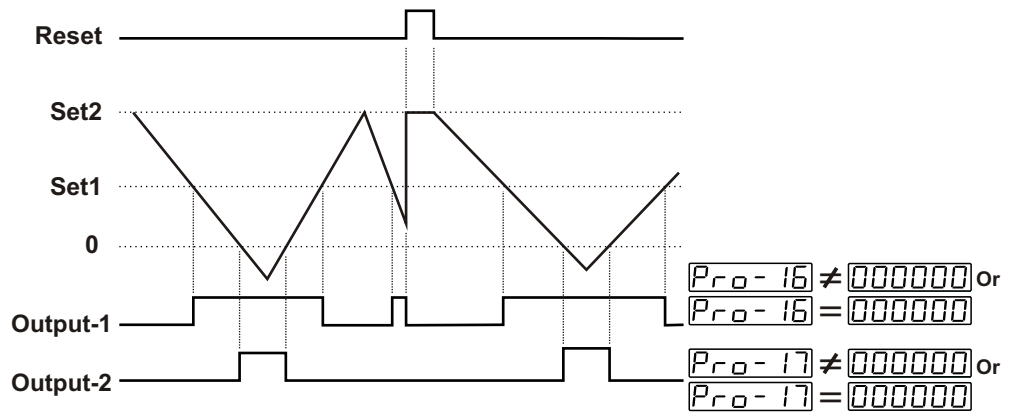

If count value is equal or less than SET1 value, then Output-1 becomes active. If it is greater than SET1 value, Output-1 becomes inactive. Output-1 pulse time Pr0-16 is not considered. If count value is equal or less than 000000 value, then Output-2 becomes active. If count value is greater than 000000 value, then Output-2 becomes inactive. Output-2 pulse time Pr0-17 is not considered.

Count value is added to total count value when Manual Reset is performed.



It is preferred if upcount and downcount is performed at the same time.

Pro-06

000007

Automatic Reset-5

Output-2 Pulse Time **Pro-17** is not considered

How it operates in **TIMER** and **CHRONOMETER** functions are explained below:

Counting direction : 0 P (Upcount)

Pro-19 = 000000

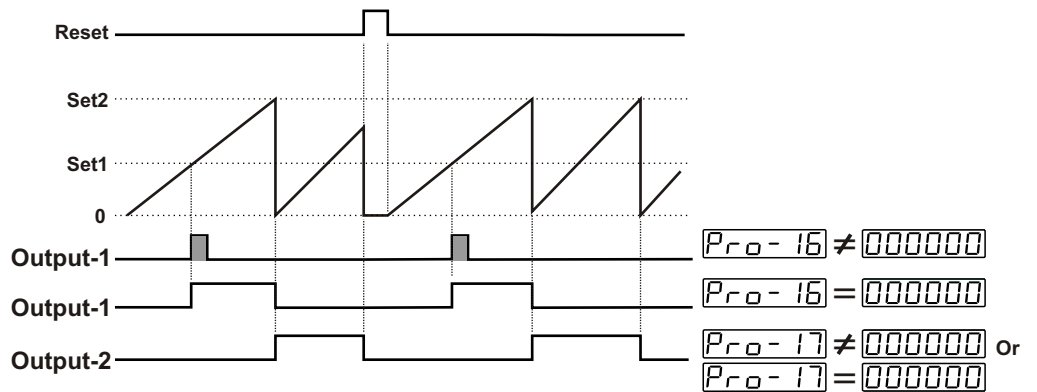

If count value is equal to or greater than SET1 value, then Output-1 becomes active. If Output-1 pulse time **Pro-16** is not 0, Output-1 changes position at the end of the pulse time. If Output-1 pulse time **Pro-16** is 000000, then Output-1 becomes inactive when count value reaches to SET2 value.

When count value reaches to SET2 value, count value is reset and Output-2 becomes active. Output-2 does not change position until count value reaches to SET2 value again.

Output-2 pulse time **Pro-17** is not considered.

Counting direction : P 0 (Downcount)

Pro-19 = 000001

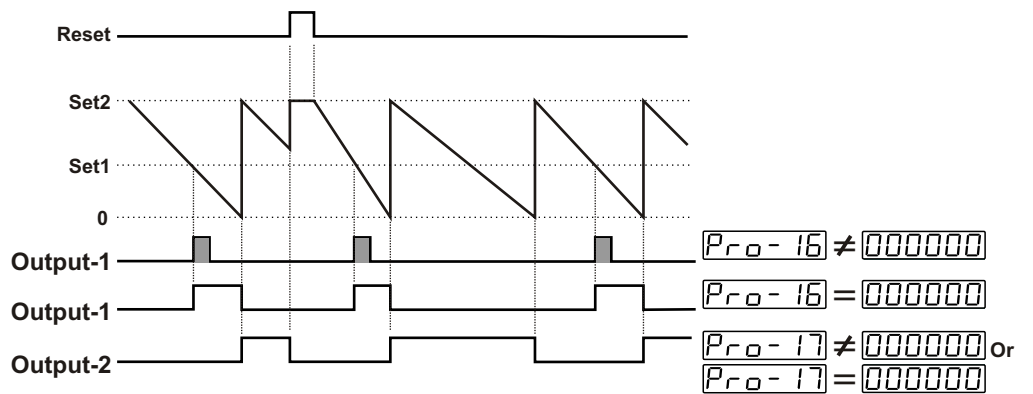

If count value is equal to or less than SET1 value, then Output-1 becomes active. If Output-1 pulse time **Pro-16** is not 0, Output-1 changes position at the end of the pulse time. If Output-1 pulse time **Pro-16** is 000000, when count value reaches to 000000, Output-1 becomes inactive.

When count value reaches to 000000, count value becomes equal to SET2 value and Output-2 becomes active. Output-2 does not change position until count value reaches to 000000 again. Output-2 pulse time **Pro-17** is not considered.

Pr0-06

Output Functions for BATCH COUNTER

Pr0-06

000000

Manual Reset

How it operates in BATCH COUNTER function is explained below:

Counting direction : 0 P (Counting to upwards)

Pr0-19 = 000000

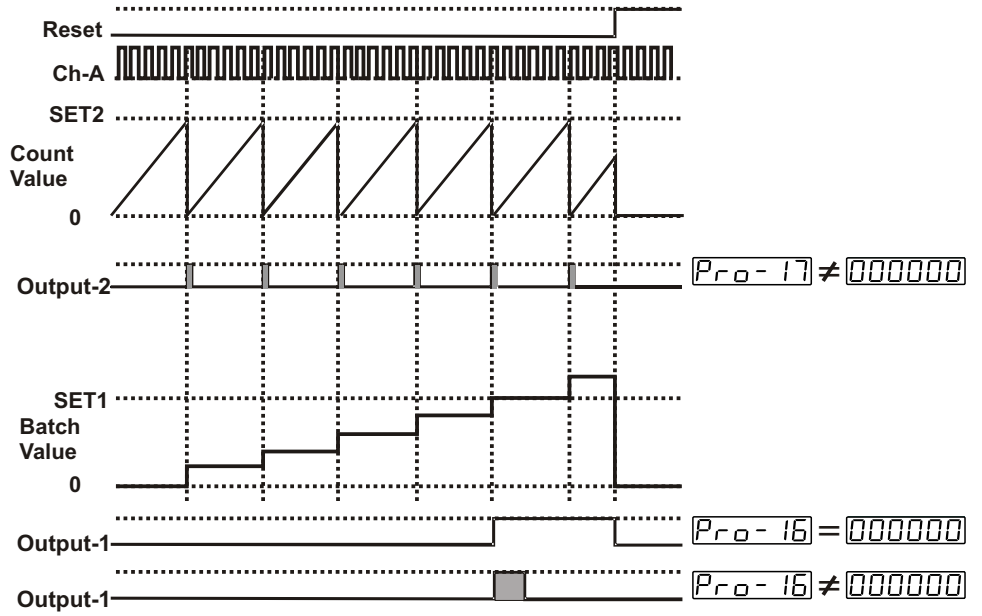

When count value reaches to SET2 value, count value is reset and Output-2 becomes active. If Output-2 pulse time Pr0-17 is 000000, then Output-2 does not change position until manual reset input is active. If Output-2 pulse time Pr0-17 is not 0, Output-2 becomes inactive at the end of the pulse time.

When Output-2 becomes active, batch count value is added 1 (Batch count value can be observed by pressing SET1 button). When number of how many times Output-2 is active becomes equal to SET-1 value, then Output-1 becomes active. If Output-1 pulse time Pr0-16 is 000000, then Output-1 does not change position until manual reset input is active. If Output-1 pulse time Pr0-16 is not, then Output-1 becomes inactive at the end of the pulse time.

How it operates in BATCH COUNTER function is explained below:

Counting Direction : P 0 (Downcount) $Pr0-19 = 000001$

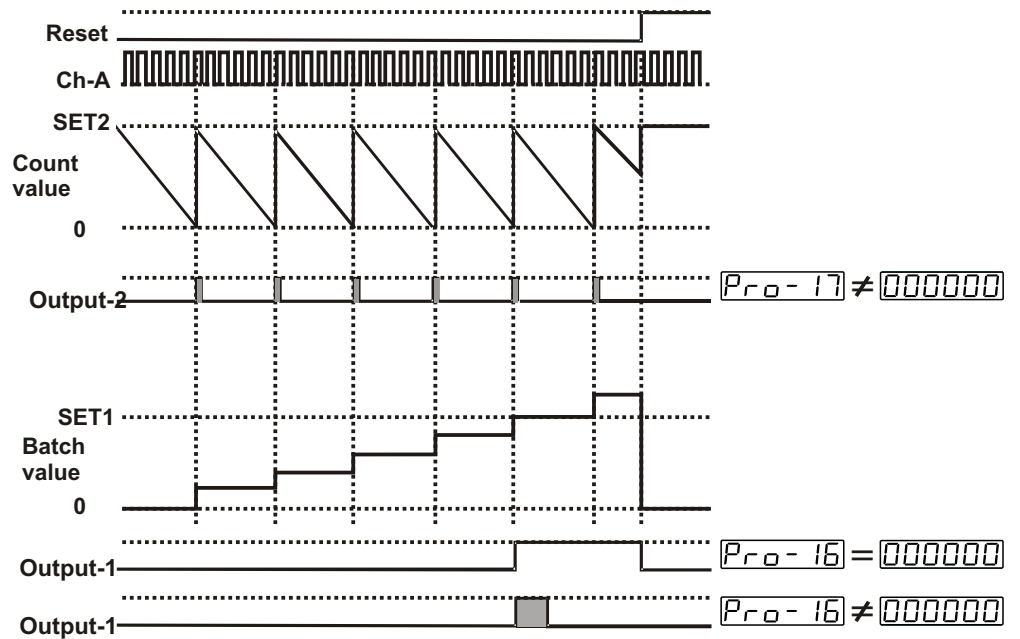

When count value reaches to 000000 , count value becomes equal to SET2 and Output-2 becomes active. If Output-2 Pulse Time $Pr0-17$ is 000000 , then Output-2 does not change position until manual reset input is active. If Output-2 pulse time $Pr0-17$ is not 0, then Output-2 becomes inactive at the end of the pulse time.

When Output-2 becomes active, batch count value is added 1 (Batch count value can be observed by pressing SET1 button). When number of how many times Output-2 is active becomes equal to SET-1 value, then Output-1 becomes active. If Output-1 pulse time $Pr0-16$ is 000000 , then Output-1 does not change position until manual reset input is active. If Output-1 pulse time $Pr0-16$ is not, then Output-1 becomes inactive at the end of the pulse time.

Pro-06

000001

Automatic Reset

How it operates in BATCH COUNTER function is explained below:

Counting direction : 0 P (Upcount)

Pro-19 = 000000

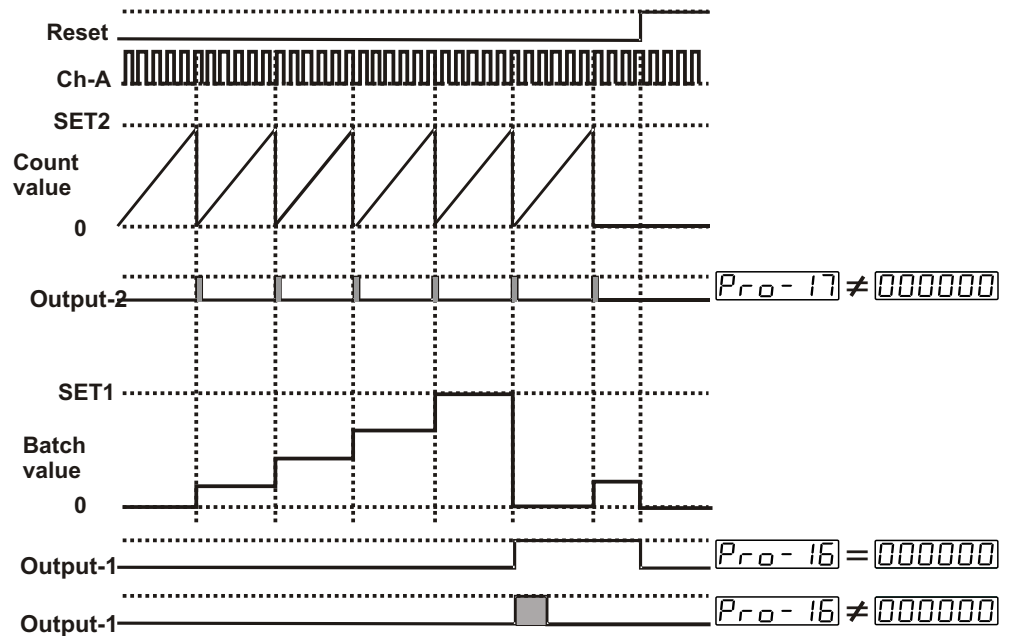

When count value reaches to SET2 value, count value is reset and Output-2 becomes active. If Output-2 pulse time $Pro-17$ is 000000 Then Output-2 does not change position until manual reset input is active. If Output-2 pulse time $Pro-17$ is not 0, Output-2 becomes inactive at the end of the pulse time.

When Output-2 becomes active, 1 is added to batch count value is (Batch count value can be observed by pressing SET1 button). When number of how many times Output-2 is active becomes equal to SET1 value, then Output-1 becomes active and Batch count value is reset automatically. If Output-1 pulse time $Pro-16$ is 000000, then Output-1 does not change position until manual reset input is active. If Output-1 pulse time $Pro-16$ is not 0, then Output-1 becomes inactive at the end of the pulse time.

Count direction : P 0 (Downcount)

Pr0-19 = 000001

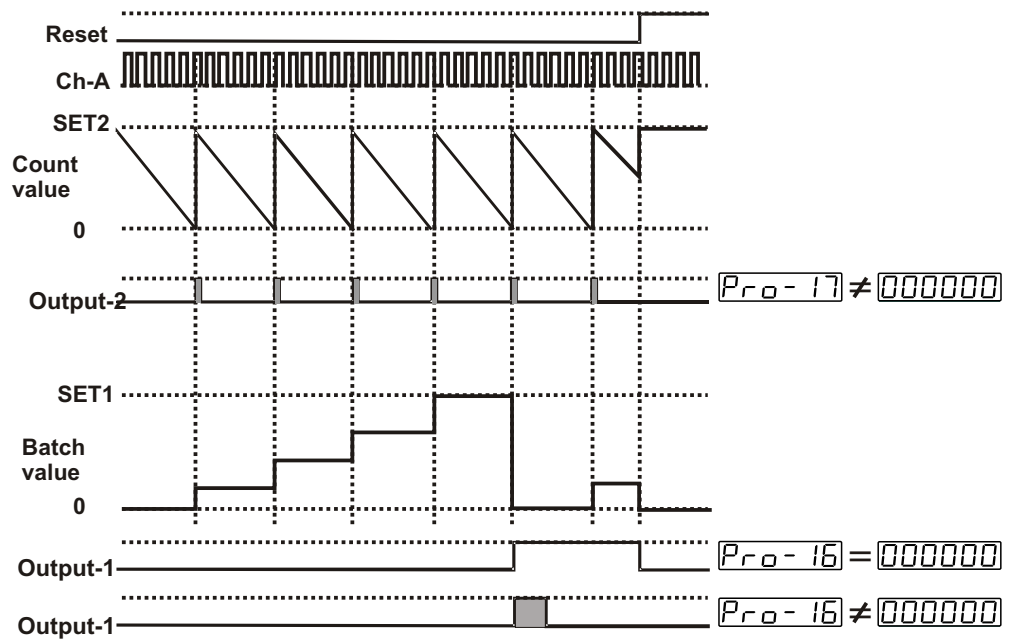

When count value reaches to 000000 value, count value becomes equal to SET2 value and Output-2 becomes active. If Output-2 pulse time $Pr0-17$ is 000000 , then Output-2 does not change position until manual reset input is active. If Output-2 pulse time $Pr0-17$ is not 0, Output-2 becomes inactive at the end of the pulse time.

When Output-2 becomes active, 1 is added to batch count value is (Batch count value can be observed by pressing SET1 button). When number of how many times Output-2 is active becomes equal to SET1 value, then Output-1 becomes active and Batch count value is reset automatically. If Output-1 pulse time $Pr0-16$ is 000000 , then Output-1 does not change position until manual reset input is active. If Output-1 pulse time $Pr0-16$ is not 0, then Output-1 becomes inactive at the end of the pulse time.

Pr0-07

Time Out (Input Signal Reset Time)
(It is accessible only in FREQUENCYMETER / TACHOMETER function)

Actual count value is reset if no signal is applied to Ch-A input for a time which is greater than the value is set in this parameter.

It can be adjusted from 000001 to 000099



This parameter is visible if Pr0-03 measurement method selection parameter is 000000. Only Ch-A input is performed in Frequencymeter/Tachometer functions

Pr0-08

Measurement Period
(It is accessible only in FREQUENCYMETER / TACHOMETER Function)

Number of pulses in Ch-A input is counted during this time

It can be adjusted from 000001 to 000999



This parameter is visible if Pr0-03 measurement method selection parameter is 000001. Only Ch-A input is performed in Frequencymeter/Tachometer functions

Pr0-09

Output-1 Function
(It is accessible only in FREQUENCYMETER / TACHOMETER Function)

000000

Output is latched. Output-1 does not change position until Manual reset is applied.

Output-1 is latched

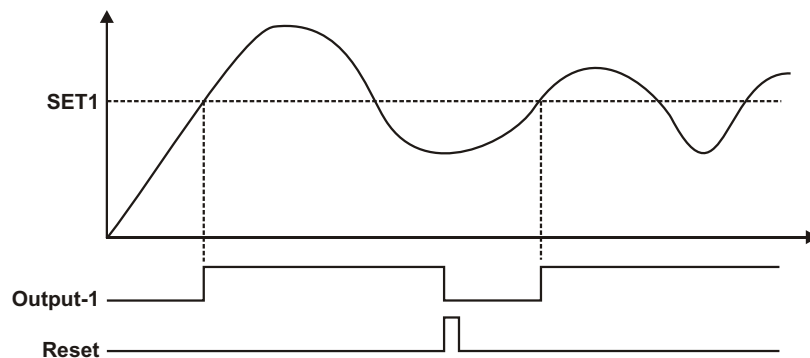

000001

Non-latched with hysteresis output is selected.

Output-1 is non-latched

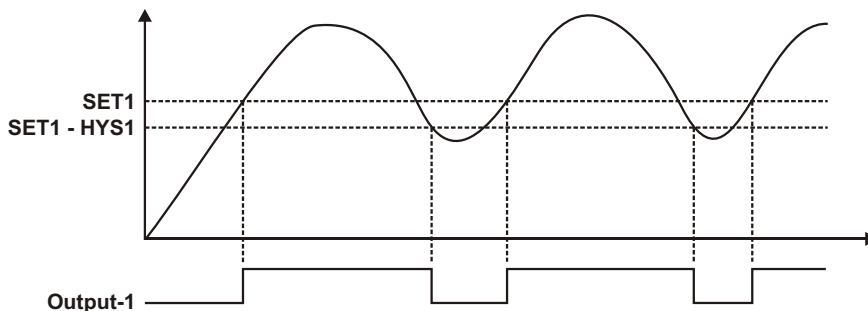

000002

Output-1 is an alarm output. For details, refer to Alarm Functions for Output-1 parameter `Pro-11`



Only Ch-A input is performed in Frequency/Tachometer functions

Pro-10

Output-2 Function

(It is accessible only in FREQUENCYMETER / TACHOMETER Function)

000000

Output is latched. Output-2 does not change position until Manual reset is applied.

Output-2 is latched

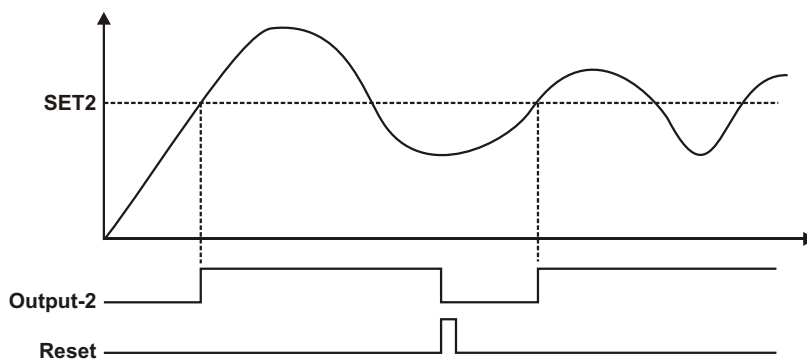

Only Ch-A input performs in Frequency / Tachometer function.

000001

Non-latched with hysteresis output is selected.

Output-2 is non-latched

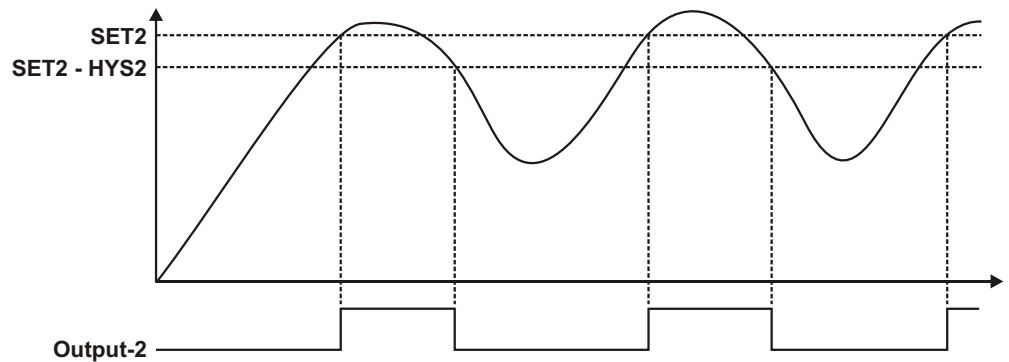

Only Ch-A input is performed in Frequency/Tachometer functions

Pro-11

Alarm Functions for Output-1
(It is accessible only in FREQUENCYMETER / TACHOMETER Function)

If Output-1 function parameter **Pro-09** is selected **000002** Alarm output, then Output-1 becomes active according to this parameter.

000000

High Alarm.

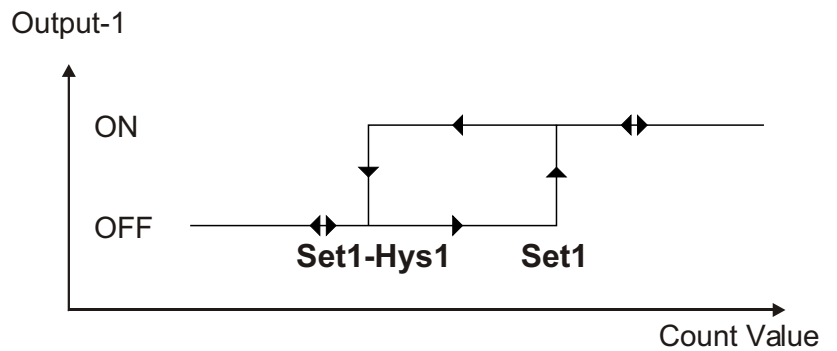

000001

Low Alarm.

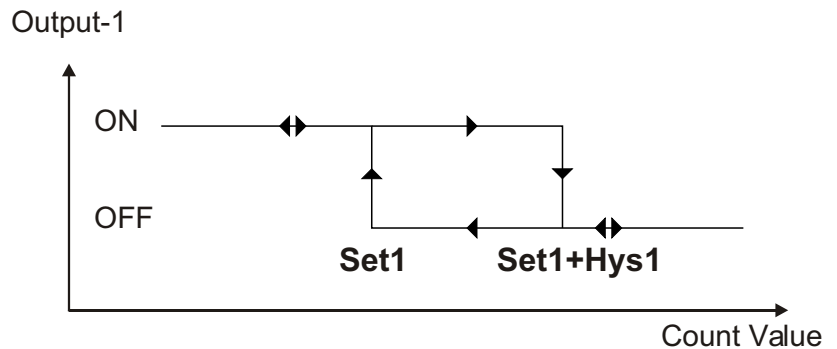

Only Ch-A input performs in Frequency/Tachometer function.

000002

Deviation High Alarm.

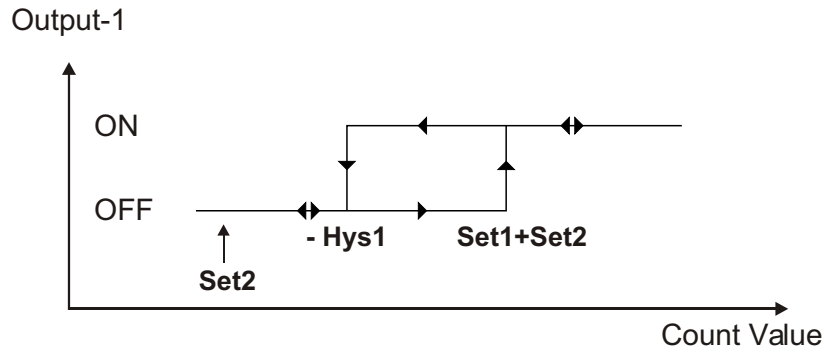

000003

Deviation Low Alarm.

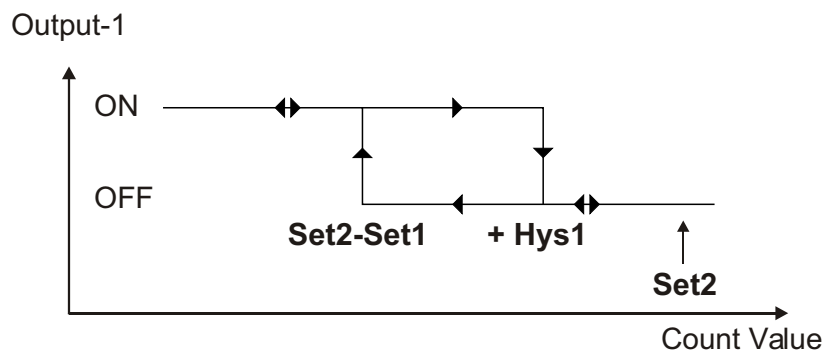

000004

Deviation Band Alarm.

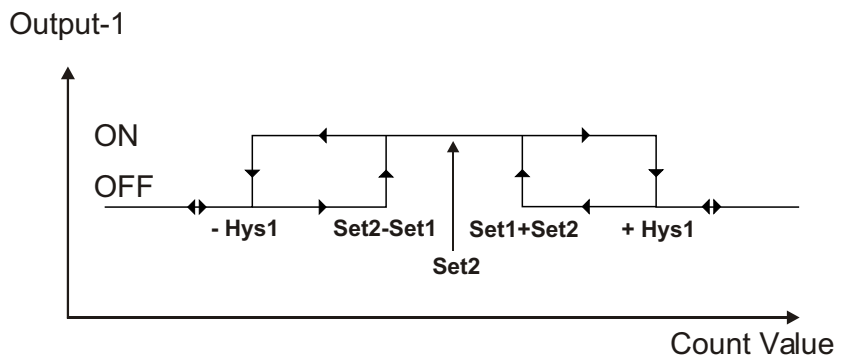

Only Ch-A input performs in Frequency Meter / Tachometer function.

Pro-12

Hysteresis for Output-1 (It is accessible in FREQUENCYMETER / TACHOMETER functions)

It defines hysteresis for Output-1. It is used if Output-1 is non-latched. It can be adjusted from 000000 to 050000



Only Ch-A input performs in Frequency Meter / Tachometer function.

Pro-13

Hysteresis for Output-2
(It is visible only in FREQUENCYMETER / TACHOMETER Function)

It defines hysteresis for Output-2. It is used if Output-2 is non-latched. It can be adjusted from 000000 to 050000



Only Ch-A input performs in Frequencymeter / Tachometer function.

Pro-14

Output-1 Operation Form

000000

Output-1 Normally non-energised

000001

Output-1 Normally energised

Pro-15

Output-2 Operation Form

000000

Output-2 Normally non-energised

000001

Output-2 Normally energised

Pro-16

Output-1 Pulse Time

It determines how long Output-1 will be active.

It can be adjusted from 0000.00 to 0099.99 seconds.

If it is 0000.00 second, then it operates indefinitely.

For details, refer to the section where output functions Pro-06 are defined

Pro-17

Output-2 Pulse Time

It determines how long Output-2 will be active.

It can be adjusted from 0000.00 to 0099.99 seconds.

If it is 0000.00 second, then it operates indefinitely.

For details, refer to the section where output functions Pro-06 are defined

Pro-18

Start of the Controlling
(It is accessible only in FREQUENCYMETER/TACHOMETER functions)

Outputs are controlled according to this parameter

000000

Control is started when the unit is energised.

000001

Control is started when count value reaches to SET1 value

000002

Control is started when count value reaches to SET2 value.

Pr0-19

Direction of Counting

(It is accessible in functions except for FREQUENCYMETER/
TACHOMETER functions)

000000

Upcount. (0 Preset)

000001

Downcount. (Preset 0)



If Input Types and Functions parameter **Pr0-01** is **000000** or **000001** in COUNTER / "TOTALIZER COUNTER" functions, then direction of counting parameter **Pr0-19** can not be accessed.

Pr0-20

Point Position for Display

(It is accessible in functions except for TIMER and
CHRONOMETER functions)

000000

No point

000000

000001

Between first and second digits

000000

000002

Between second and third digits

000000

000003

Between third and fourth digits

000000

000004

Between fourth and fifth digits

000000

Pr0-21

Saving Count Value (Power down back-up)

(It is accessible in functions except for FREQUENCYMETER/
TACHOMETER functions)

000000

Count value is saved to memory when power is disconnected and restored on power up.

000001

Count value is not saved to memory when power is disconnected. When power up **000000** is shown on the screen.

Pro-22

SET1 Operation Form Selection
(It is accessible only in COUNTER / "TOTALIZER COUNTER"
Function)

000000

Absolute operation. SET1 can be adjusted from 000000 to 999998

000001

Operation with offset. SET1 can be defined \pm Offset according to SET2 value. (SET1 = SET1 + SET2)

For example ;if operation with offset is selected, SET1 = 5000, SET2 = 10000.

Output-1 becomes active or inactive according to SET1 = 5000 + 10000 = 15000 value

For example; If operation with offset is selected ;
If 6th digit of the SET1 is adjusted to "-", SET1 becomes negative (For details, refer to Section 7.3)

SET1 = -05000 ; SET2 = 10000

Output-1 becomes active or inactive according to SET1 = -5000 + 10000 = 5000 value

Pro-23

Slave Address

Device address for serial communication bus.

It can be adjusted from 000001 to 000247

Pro-24

Modbus Protocol Type Selection

000000

Modbus **ASCII** protocol is selected

000001

Modbus **RTU** protocol is selected

Pro-25

Communication Parity Selection

000000

No parity

000001

Odd Parity

000002

Even Parity

Pro-26 Baud Rate

- 000000** 1200 Baud Rate
- 000001** 2400 Baud Rate
- 000002** 4800 Baud Rate
- 000003** 9600 Baud Rate
- 000004** 19200 Baud Rate

Pro-27 Communication Stop Bit selection

- 000000** 1 Stop Bit
- 000001** 2 Stop Bits

Pro-28 Reset and Set protection (For accessing from front panle)

- 000000** There is no Reset and Set protection
- 000001** Only RESET button protection is active. Actual value can not be reset by Reset button.
Actual value can be reset only reset input is active
- 000002** SET1 and SET2 can not be changed.
- 000003** Full protection ; Reset protection is active, also SET1 and SET2 can not be changed.
- 000004** SET1 can not be changed.
- 000005** SET2 can not be changed.

Pro-29 Frequency / Cycle Coefficient
(It is accessible only in FREQUENCYMETER / TACHOMETER functions)

It can be adjusted from **000001** to **009999**. Count value is multiplied with this parameter.
If it is **000001** multiplication is not performed. So number of pulses are displayed without having any changes.

Pr0-30

Multiplication Coefficient (It is accessible except for TIMER and CHRONOMETER functions)

It can be adjusted from to . Changes in this parameter is evaluated when counting starts.

If it is multiplication is not performed. So number of pulses are displayed without having any changes.

Pr0-PS

Program Password

It is used for accessing to the program parameters. It can be adjusted from to .

If it is , there is no password protection while accessing to the parameters.

When programming button is pressed, will appear on the display.

If program password is not "0" while accessing to the program parameters ;

1- If user does not enter the value correctly ; operation screen will appear without entering to operator parameters.

2- When in top display and in bottom display, if user presses ENTER button without entering password (for observing the parameters):

User can see all parameters except Program Password but device does not allow to do any changes with parameters.

(Please refer to Section 9. Failure Messages in EZM-9950 Programmable Timer & Counter (2))

9. Failure Messages in EZM-9950 Programmable Timer & Counter

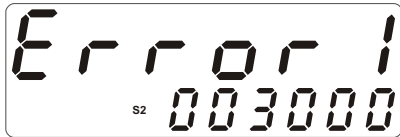

1 - Position of the DIP Switch is wrong. (DIP Switch determines the operation function of the device and it is under the top cover)

For details, refer to Section 2.8 "Selection of Operation Function and Input Type with DIP Switch".

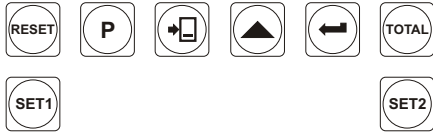

2 - If the password is not 0, user can access to the parameters without entering the password and by pressing ENTER button.

User can see all parameters except for programming password parameter `Pr0-PS` but user can not do any changes in parameters. If password is entered for accessing to the parameters correctly, most significant digit of the parameter flashes. But if the password is not entered, flashing of the most significant digit is not realised.

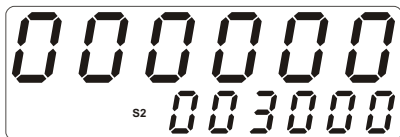

Operation Screen

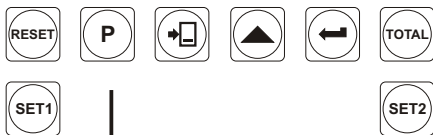

When PROG button is pressed, password entering screen will appear.



Password Screen

The most significant digit of the parameter (4th digit for this parameter) flashes.

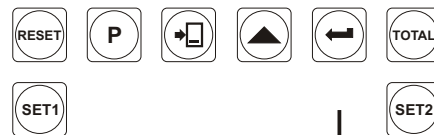

Press ENTER button without entering the password.

For COUNTER /
"TOTALIZER COUNTER"
Function



Input Types
and Functions

No digit flashes.

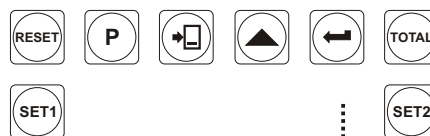

By pressing ENTER button, user can see all parameters except for program password

For COUNTER /
"TOTALIZER COUNTER"
function

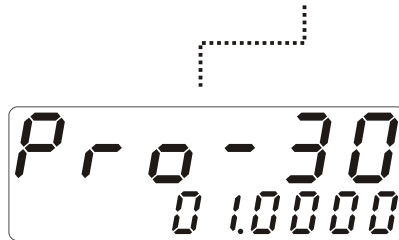

Multiplication Coefficient

Press PROG button to exit
from programming mode.



Continue to press ENTER
button for scanning the
parameters.

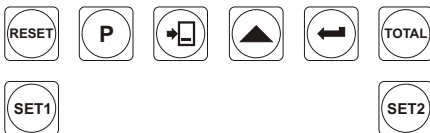
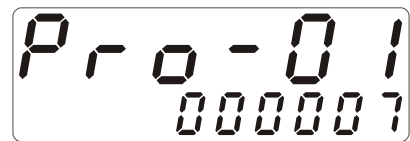
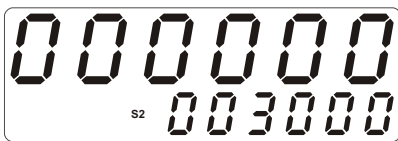

Operation Screen



Input Types and
Functions

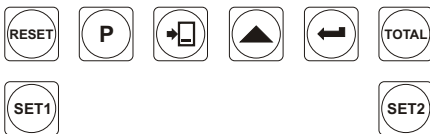

3 - If Actual Value is flashing and counting is stopped ;
It appears if any of the count value is greater than the
maximum count value.

(Total count value for Counter/"Totalizer Counter"
Function - Batch count value for Batch Counter
FUNCTION)

To remove this warning and reset the count value press
RESET button.

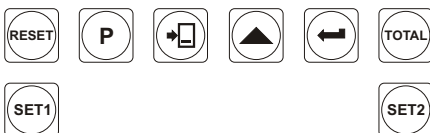

4 - If actual value is flashing and counting is not
performed;

It appears if any of the count value is less than the
minimum count value.

(Total count value for Counter/"Totalizer Counter"
Function - Batch count value for Batch Counter
FUNCTION)

To remove this warning and reset the count value press
RESET button.

10. Specifications

Device Type	: Programmable Timer & Counter
Housing & Mounting	: 96mm x 96mm x 87.5mm 1/4 DIN 43700 plastic housing for panel mounting. Panel cut-out is 92x92mm. Type-1 Enclosure Mounting.
Protection Class	: IP65 at front, IP20 at rear.
Weight	: Approximately 0.34 Kg.
Environmental Ratings	: Standard, indoor at an altitude of less than 2000 meters with none condensing humidity
Storage / Operating Temperature	: -40 °C to +85 °C / 0 °C to +50 °C
Storage / Operating Humidity	: 90 % max. (None condensing)
Installation	: Fixed installation
Over Voltage Category	: II
Pollution Degree	: II, office or workplace, none conductive pollution
Operating Conditions	: Continuous
Supply Voltage and Power	: 100 - 240 V \sim 50/60 Hz. (-15% / +10%) 6VA 24 V \sim 50/60 Hz. (-15% / +10%) 6VA 24 V \equiv (-15% / +10%) 6W
Electrical Characteristics Of Digital Inputs	: Rated voltage : 16 VDC @ 5mA Maximum continuous permissible voltage : 30 VDC Logic 1 minimum level : 3 VDC Logic 0 maximum level : 2 VDC
Maximum Input Frequency	: For Counter / "Totalizer Counter" and Batch Counter ; If $\overline{Pr0-01} = 0, 1, 2$; 6000Hz If $\overline{Pr0-01} = 3, 4$; 4000Hz If $\overline{Pr0-01} = 5, 6$; 3500Hz If $\overline{Pr0-01} = 7$; 2000Hz For Frequency/Tachometer ; 10kHz Max 30 Hz ($\overline{Pr0-04} \neq \overline{000000}$, debounce)
Optional Output Modules	:-EMO-900 Relay Output Module (5A@250V \sim) 100.000 operation (Full Load) -EMO-910 SSR Driver Output Module(Max. 26mA, 22V \equiv) -EMO-920 Digital (Transistor) Output Module (Max. 40mA@18V \equiv)
Standard Communication Module	: EMC-900 RS-232 Communication Module
Optional Communication Module	: EMC-910 RS-485 Communication Module
Communication Protocol	: MODBUS-RTU, MODBUS-ASCII
Process Display	: 14 mm Red 6 digit LED display
Set Display	: 9 mm Green 6 digit LED display
Led Indicators	: SV1 (Set1 value), SV2 (Set2 value) , OP1 / 2 (Control or Alarm Output) LEDs
Approvals	: UL Recognized Component(File Number: E 254103), EAC , CE

11. Other Informations

Manufacturer Information:

Emko Elektronik Sanayi ve Ticaret A.Ş.
Demirtaş Organize Sanayi Bölgesi Karanfil Sk. No:6 16369
BURSA/TURKEY

Phone : +90 224 261 1900

Fax : +90 224 261 1912

Repair and Maintenance Service Information:

Emko Elektronik Sanayi ve Ticaret A.Ş.
Demirtaş Organize Sanayi Bölgesi Karanfil Sk. No:6 16369
BURSA/TURKEY

Phone : +90 224 261 1900

Fax : +90 224 261 1912



Thank you very much for your preference to use Emko Elektronik Products.

www.emkoelektronik.com.tr