

Fellowes

SafeCut™ Rotary Trimmers

Neutron™ / Neutron™ Plus

Proton™

Electron™

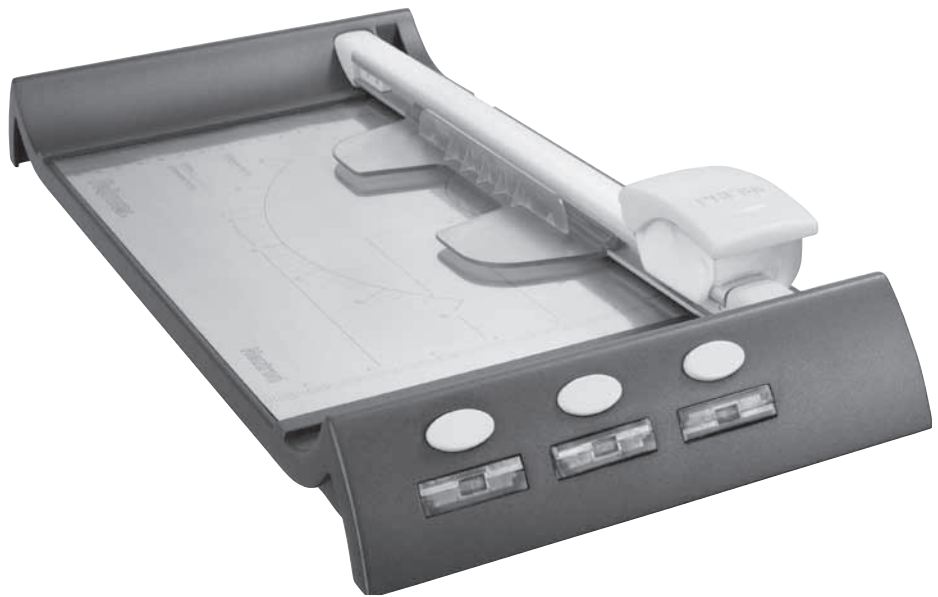

Please read these instructions before use.
Do not discard: keep for future reference.

Lire ces instructions avant utilisation.
Ne pas jeter : conserver pour référence ultérieure.

Lea estas instrucciones antes de usarlo.
No las deseche: guárdelas para tenerlas como referencia.

Diese Anleitungen vor Gebrauch genau durchlesen.
Bitte nicht entsorgen: Zur späteren Bezugnahme aufheben.

Prima dell'uso, si raccomanda di leggere questo manuale di istruzioni.
Conservare il manuale per consultarlo secondo le necessità.

Deze instructies voor gebruik lezen.
Niet weggoeien, maar bewaren om later te kunnen raadplegen.

Läs dessa anvisningar innan du använder apparaten.
Släng inte bort, behåll för framtida bruk.

Læs venligst denne vejledning før anvendelse.
Bør ikke bortskaffes. Behold for fremtidig henvisning.

Lue nämä ohjeet ennen käyttöä.
Älä hävitä: säilytä myöhempää käyttöä varten.

Vennligst les nøye igjennom denne bruksanvisningen før bruk.
Ikke kast den: Ta vare på den for senere referanse.

Przed użyciem proszę zapoznać się z tą instrukcją.
Nie wyrzucać - zachować jako źródło informacji na przyszłość

Перед началом эксплуатации обязательно прочтите данную инструкцию.
Не выбрасывайте данную инструкцию: сохраните ее для последующего использования.

Παρακαλείσθε να διαβάσετε αυτές τις οδηγίες πριν χρησιμοποιήσετε το προϊόν.
Μην τις απορρίψετε: κρατήστε τις για μελλοντική αναφορά.

Kullanmadan önce lütfen bu talimatları okuyun.
Atmayın: ileride başvurmak üzere saklayın.

Před použitím si přečtěte tyto pokyny.
Nelikvidujte: uschovejte pro budoucí použití.

Pred použitím si prečítajte tieto pokyny.
Nezahadzujte: odložte pre budúce použitie.

Kérjük, hogy használat előtt olvassa el az utasításokat!
Az utasításokat ne dobja ki; tartsa meg referenciaanyagként való jövőbeni használatra.

Leia estas instruções antes da utilização.
Não as deite fora: conserve-as para consulta futura.

ENGLISH

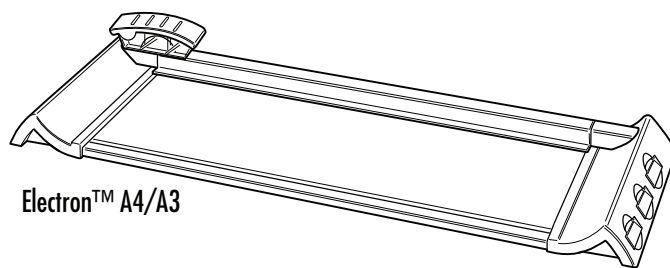

Electron™ A4/A3

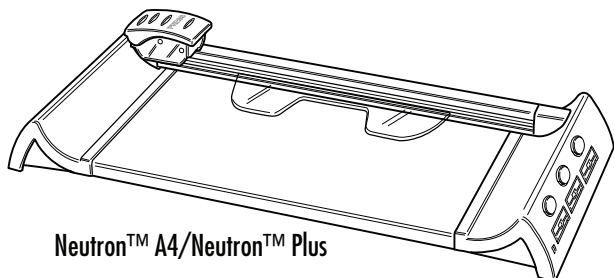

Neutron™ A4/Neutron™ Plus

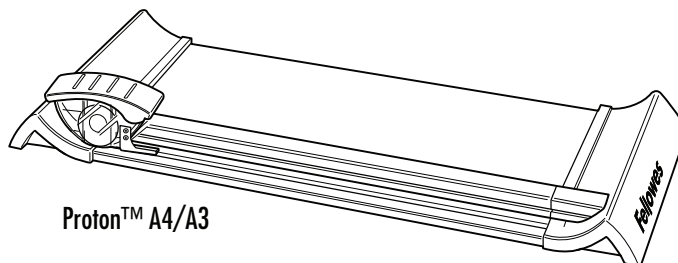

Proton™ A4/A3

CAPACITIES AND CONTENT

CRC #	Model	Number of blades	Cutting Length (mm)	Cutting Length (inch)	Cutting capacity (sheets 80 gsm)
54100	Neutron A4	1	320	12	10
54101	Neutron Plus	4	320	12	10
54102	Proton A4	1	320	12	10
54103	Proton A3	1	460	18	10

CRC #	Model	Number of blades	Cutting Length (mm)	Cutting Length (inch)	Cutting capacity (sheets 80 gsm)
54104	Electron A4	4	320	12	10
54105	Electron A3	4	460	18	10

IMPORTANT SAFETY INSTRUCTIONS — Read Before Using!

CAUTION

- Caution: blades are extremely sharp.
- SafeCut™ cassette encloses blades — do not try to extract blades manually.
- Always supervise children during use.
- Do not overload trimmer.
- Keep pets away from trimmer while in use.
- Do not open or attempt to repair, as this will void your warranty. Contact CustomerService if you have questions. Please note the warranty does not apply in cases of abuse, mishandling or unauthorized repair.
- Do not try to open SafeCut™ blade cartridges.

Need Help?

Customer Service
www.fellows.com
 Let our experts help you
 with a solution.
 Always call Fellows
 before contacting
 your place of purchase.

CUTTING PAPER AND PHOTOS

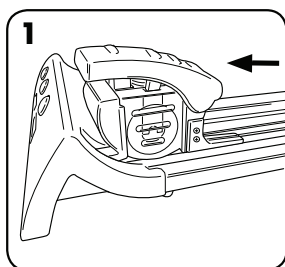

1. Slide cutting carriage to one end into lock position.

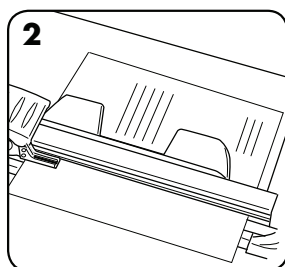

2. Place item (e.g. photo or paper) onto cutting table.

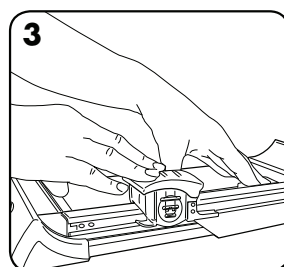

3. Hold paper steady with hand or clamping mechanism. To activate cutting blade, push down carriage handle. (Electron: when pressing handle down, LED will glow).

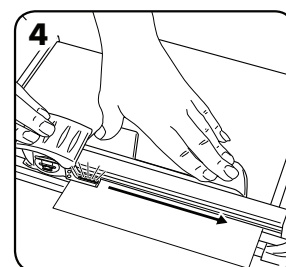

4. To cut, push handle downwards and slide carriage along until reaching the end of the bar. At the end of the bar, release the carriage and the clamping mechanism will release.

ENGLISH

SAFECUT™ SAFETY FEATURES

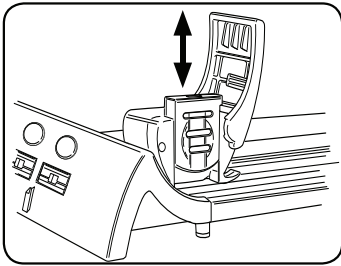



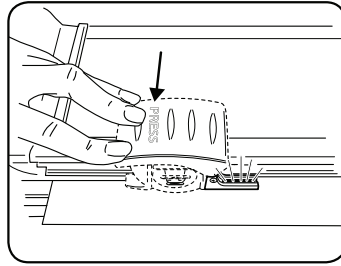



The SafeCut™ cartridge system allows users to change the cutting cartridge without touching the blades.

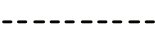

The SafeCut™ LED Guide on the Electron trimmer for illuminated precision. Safer than laser guides.

ACCESSORY PACKS

3 Creative SafeCut™ blades			Cutting capacity (sheets 80 gsm)
		Wave Cut	5
		Perforate	5
		Fold (crease)	3

CRC#	Pack contents
54113	3 Creative SafeCut™ blades (1x wave, 1x perforate, 1x fold)
54114	2 Straight SafeCut™ blades
54115	A4 Cutting strips (x3)
54116	A3 Cutting strips (x3)

CHANGING BLADE CASSETTE

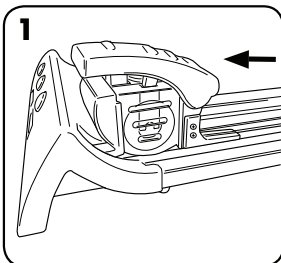

1. Slide cutting carriage to one end into lock position.

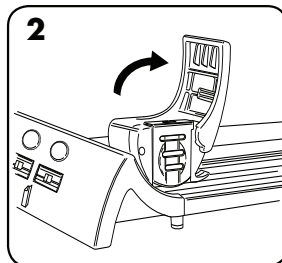

2. Lift carriage handle up.

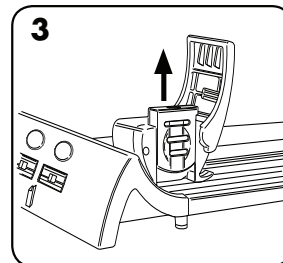

3. Pull SafeCut™ cartridge upwards out of cutting carriage and insert new cartridge (push down to click into place).

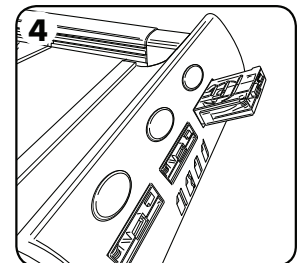

4. Press yellow button to release cassette from base. Return unused SafeCut™ into storage slot in base.

CHANGING CUTTING STRIP

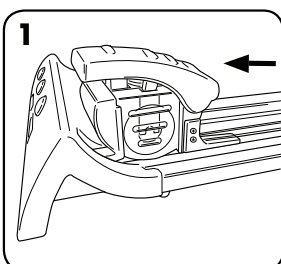

1. Slide cutting carriage to one end into lock position.

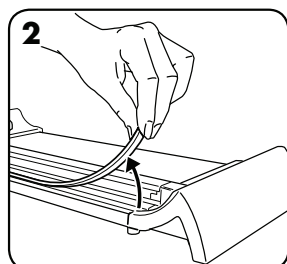

2. Remove cutting strip off trimmer base.

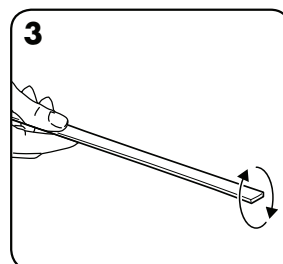

3. Turn cutting strip over to use both sides.

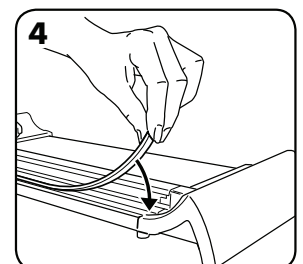

4. Replacement strips available (see accessory details).

ENGLISH

ELECTRON SAFECUT™ LED GUIDE

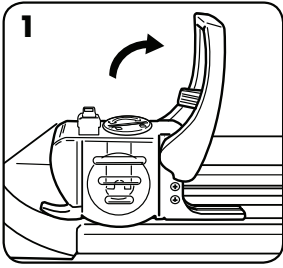

1. Slide cutting carriage to one end into lock position. Pull (swing) carriage handle up.

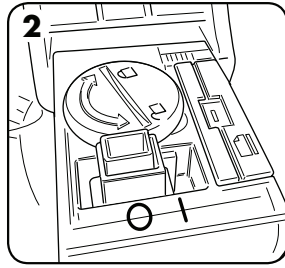

2. Turn switch to ON (I) position.

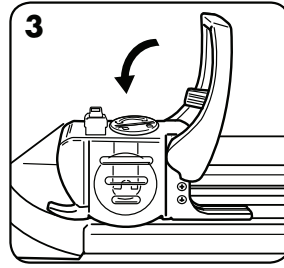

3. Pull (swing) carriage handle down.

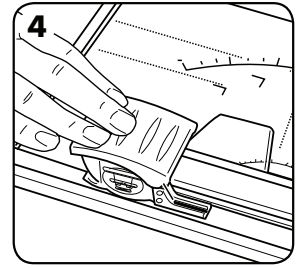

4. Press handle down to activate SafeCut™ LED Guide.

CHANGE BATTERY ON ELECTRON SAFECUT™ LED GUIDE

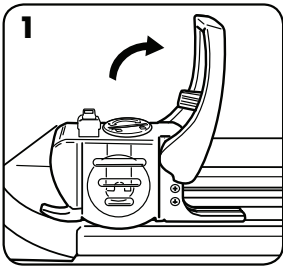

1. Slide cutting carriage to one end into lock position. Pull (swing) carriage handle up.

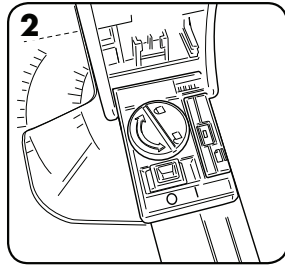

2. Unscrew battery cover with coin or screwdriver (left turn opens, right turn closes battery cover).

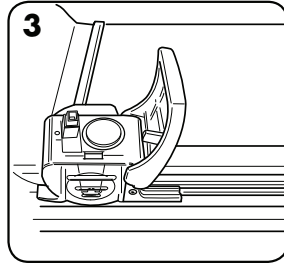

3. Remove old battery and replace with new battery [type CR2023].

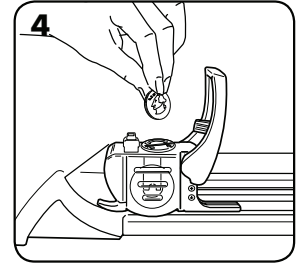

4. Close battery cover.

WARRANTY

Fellowes warrants all other parts of the machine to be free of defects in material and workmanship for 2 year from the date of purchase by the original consumer. If any part is found to be defective during the warranty period, your sole and exclusive remedy will be repair or replacement, at Fellowes' option and expense, of the defective part. This warranty does not apply in cases of abuse, mishandling, or unauthorized repair. ANY IMPLIED WARRANTY, INCLUDING THAT OF MERCHANTABILITY OR FITNESS FOR A PARTICULAR PURPOSE, IS HEREBY LIMITED IN DURATION TO THE APPROPRIATE WARRANTY

Australia Residents Only:

Our goods come with guarantees that cannot be excluded under the Australian Consumer Law. You are entitled to a replacement or refund for a major failure and for compensation for any other reasonably foreseeable loss or damage. You are also entitled to have the goods repaired or replaced if the goods fail to be of acceptable quality and the failure does not amount to a major failure. The benefits under Fellowes' Warranty are in addition to other rights and remedies under a law in relation to the trimmer.

PERIOD SET FORTH ABOVE. In no event shall Fellowes be liable for any consequential or incidental damages attributable to this product. This warranty gives you specific legal rights. The duration, terms, and conditions of this warranty are valid worldwide, except where different limitations, restrictions, or conditions may be required by local law. For more details or to obtain service under this warranty, please contact us or your dealer. Accessories and consumables are excluded from this warranty.

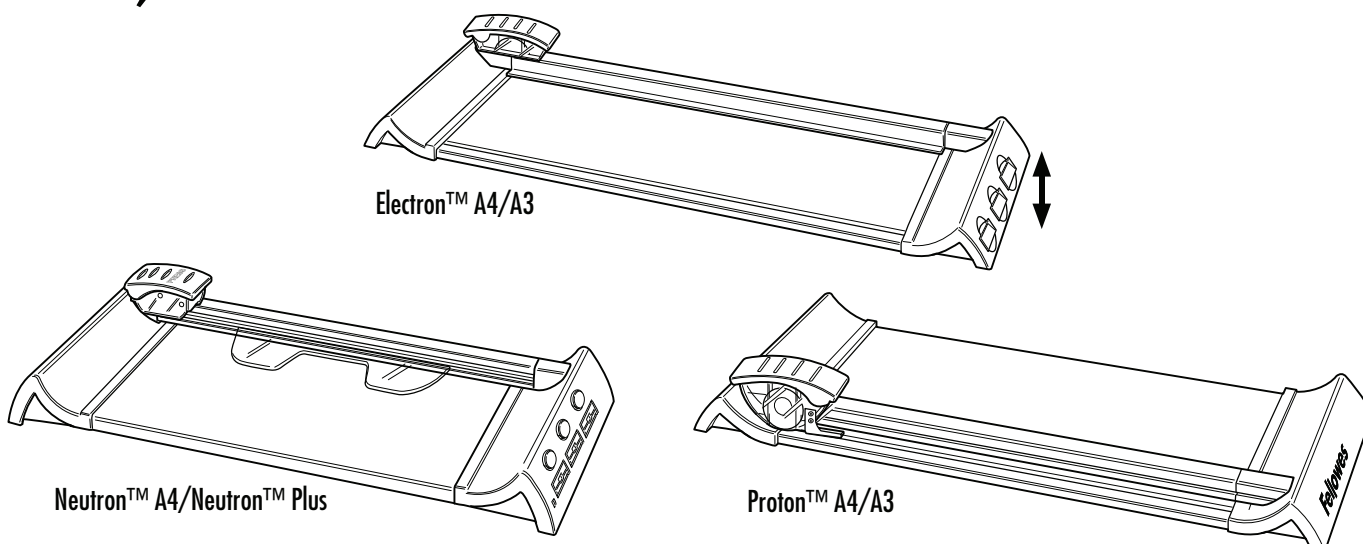

Electron™ A4/A3

Neutron™ A4/Neutron™ Plus

Proton™ A4/A3

CAPACITÉS ET CONTENUS

CRC n°	Modèle	Nombre de lames	Longueur de la coupe (mm)	Capacité de coupe (feuilles 80 gsm)
54100	Neutron A4	1	320	10
54101	Neutron Plus	4	320	10
54102	Proton A4	1	320	10
54103	Proton A3	1	460	10

CRC n°	Modèle	Nombre de lames	Longueur de la coupe (mm)	Capacité de coupe (feuilles 80 gsm)
54104	Electron A4	4	320	10
54105	Electron A3	4	460	10

CONSIGNES DE SÉCURITÉ IMPORTANTES — Lire attentivement avant d'utiliser l'appareil !

ATTENTION

- Attention : Les lames sont très coupantes.
- Le boîtier SafeCut™ contient des lames — ne pas essayer d'extraire manuellement les lames.
- Toujours surveiller les enfants pendant l'utilisation.
- Ne jamais surcharger le massicot.
- Tenir les animaux domestiques hors de portée du massicot lors de son utilisation.
- Ne pas ouvrir ou essayer de réparer, car cela pourrait annuler votre garantie. Contacter le Service clientèle pour toute question. Cette garantie ne s'applique pas en cas d'utilisation abusive, de manipulation inappropriée ou de réparation non autorisée.
- Ne pas essayer d'ouvrir les cartouches de lames SafeCut™.

Vous avez besoin d'aide ?

Service à la clientèle
www.fellowes.com
 Consultez nos experts pour trouver une solution. Appelez toujours Fellowes avant de contacter le point de vente.

COUPER DU PAPIER ET DES PHOTOS

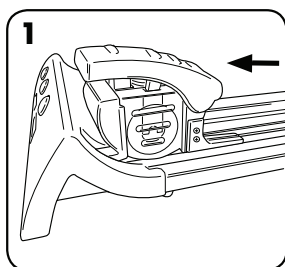

1. Faire glisser le chariot de coupe vers l'une des extrémités pour le mettre en position de blocage.

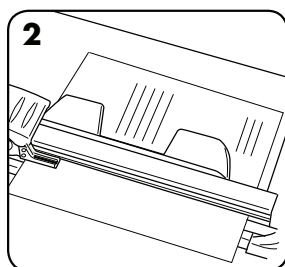

2. Placer l'objet (c.-à-d. la photo ou le papier) sur l'établi de coupe.

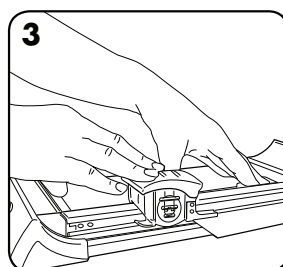

3. Tenir fermement le papier à la main ou avec la pince à serrer. Pour activer la lame de coupe, pousser la poignée du chariot vers le bas. (Electron : le voyant s'allume quand on presse la poignée vers le bas).

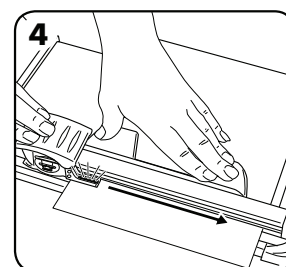

4. Pour couper, pousser la poignée vers le bas et faire glisser le chariot jusqu'à atteindre le bout de la barre. Arrivé au bout de la barre, relâcher le chariot et la pince de serrage se débloquent d'elle-même.