

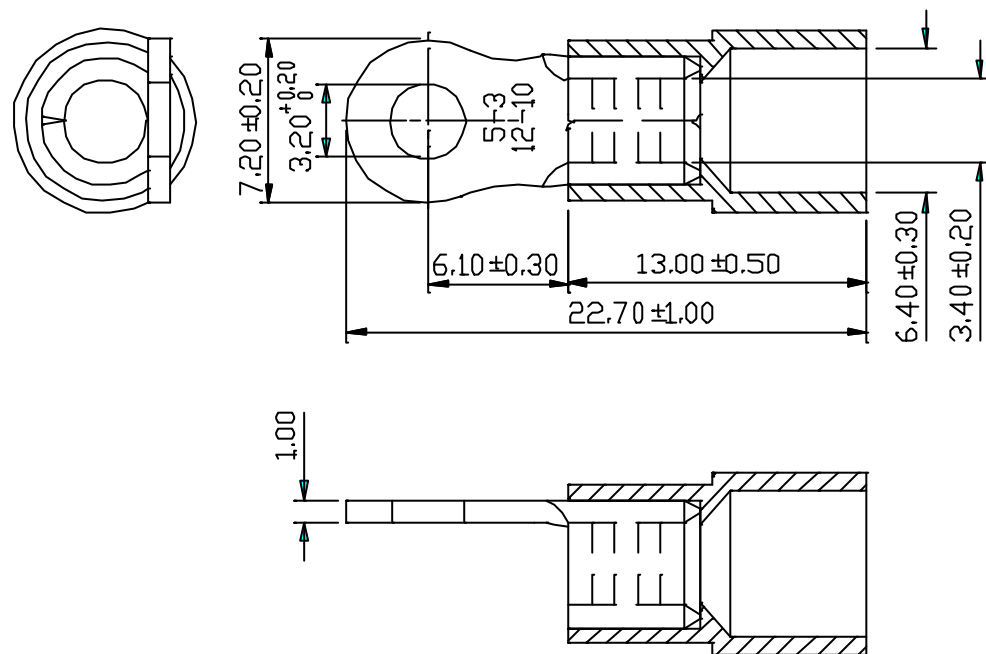

REV	DESCRIPTION	DATE
-----	-------------	------



NOTE:

1. MAXIMUM ELECTRIC CURRENT:

A.W.G.	12	10
AMP.	35	50
2. MAXIMUM ELECTRICAL RATING:
75°C 600 VOLTS MAX.
3. INSULATION MATERIAL: VINYL
4. INSULATION COLOR: YELLOW
5. TERMINAL MATERIAL: COPPER
6. WIRE RANGE: 12-10A.W.G. (4-6mm²)

Tolerance Unless Otherwise Specified	
0 >	MM ± ANGLE
>	MM ± 0° REF ±
>	MM ± ° ±
>	MM ± ° ±

NAME	VINYL-INSULATED RING TERMINALS			UNIT	mm	
PART NO.	RVY5-3.2@	MATERIAL		APPROVE		
NUMBER	TZV-195	SCALE	SHEET	PAGE	CHECKED	
DATE	09/06/2005	3 : 1	1-0	1 OF 1	DRAWN	