



Product Features

- Universal input voltage / Full range: 90~305Vac;
- Constant power design, outputs programmable;
- Output current reconfigurable by infrared controller;
- 3-in-1 dimmable (M types): 0~10Vdc / PWM signal /

Timer dimming;

- Surge protection: 5KV line-line, 10KV line-earth;
- Protections: SCP / OVP / OTP; temperature;
- IP67 design for indoor and outdoor applications;
- Suitable for dry / damp / wet locations;
- 5 years warranty

Application

- Suitable for LED architecture lighting, industrial lighting, flood lighting, and roadway lighting, etc.



DESCRIPTION

The LDP-75W series is 75W outdoor programmable LED driver that operates in constant current model. Monitored by an infrared based programming device, the fully programmed drivers offer all dimming options and a wide range of output current in a single driver, which deliver maximum flexibility with customized operating settings and intelligent control options for lighting manufacturers, as one driver can be programmed for many different luminaire designs. LDP provides built-in timer dimming schedules further increasing the energy savings and CO₂ reductions achieved with LED lighting. It also helps clients to improve the management of logistics and stock. The compact metal case and high efficiency enables the driver to operating with high reliability, and extending product lifetime. Overall protection is provided against lightning surge, output over voltage, short circuit, and over temperature, to ensure low failure rate.

MODELS

Model Number	Max Output Power (W)	Output Voltage Range (Vdc)	Output Current Adjustable Range (A)	Full Power Current Adjustable Range (A) [2]	Default Output Setting	Typical Efficiency [3]	Power Factor	
							115Vac	230Vac
LDP-075X054H [1]	75	20~54	0.21~2.10	1.40~2.10	20~36V/2.10A	87%	0.99	0.97
LDP-075X141H	75	60~141	0.11~1.10	0.53~1.10	60~107V/0.70A	88%	0.99	0.97
LDP-075X270H	75	120~270	0.05~0.53	0.28~0.53	120~214V/0.35A	88%	0.99	0.97

Notes:

[1]. X can be M or R, means dimmable or non-dimmable. Take LDP-075X054H for example, LDP-075M054H is programmable and 3-in-1 dimmable; LDP-075R054H is programmable and timer dimmable;

[2]. Output current adjustable range with constant power at max output power;

[3]. All specifications are measured at 25°C ambient temperature, if no specific note.

OPERATING AREA I-V

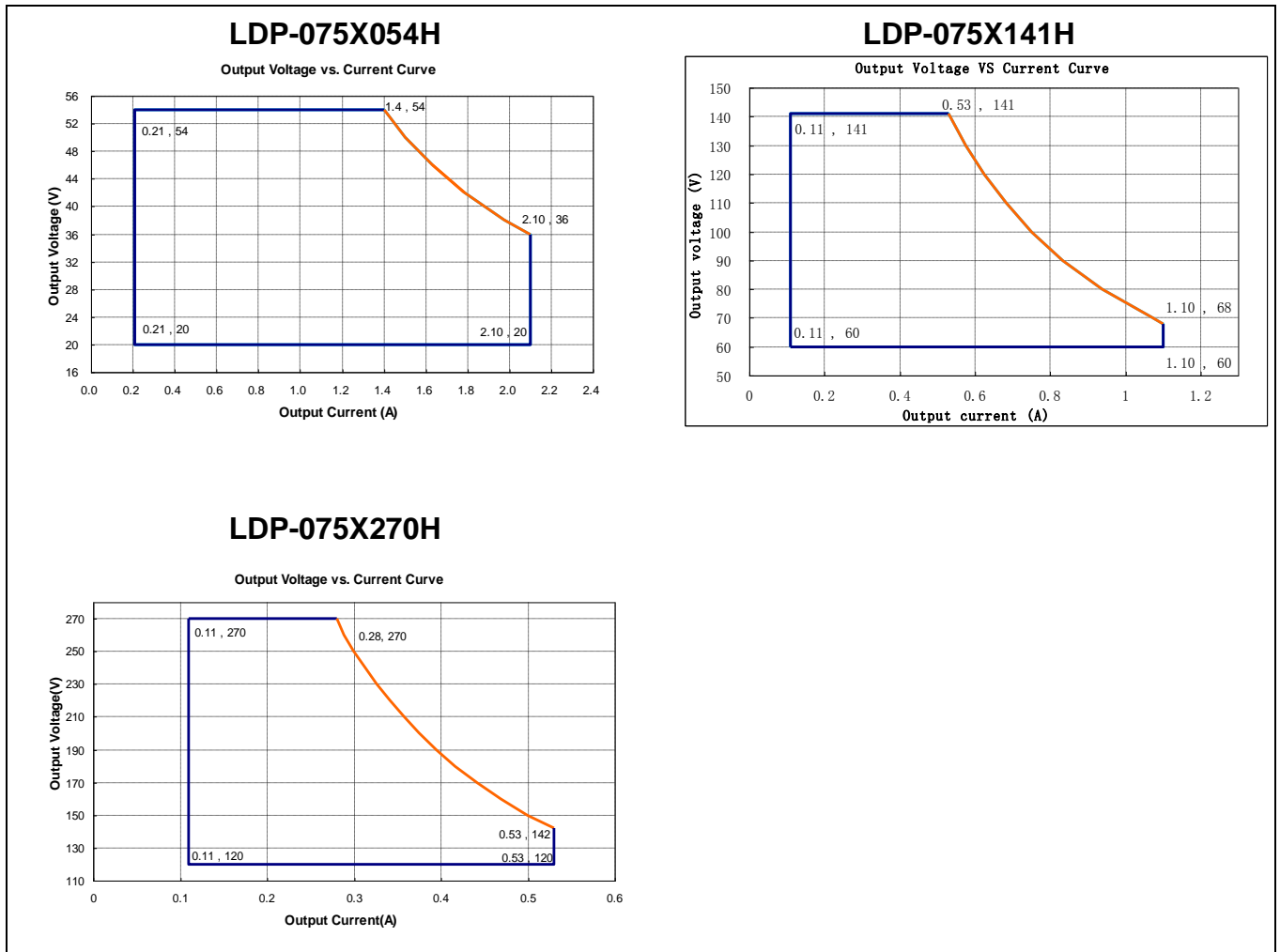

INPUT SPECIFICATIONS

Parameter	Min.	Typ.	Max.	Notes
Input Voltage	90Vac	100-277Vac	305Vac	
Input Frequency	47HZ	50/60	63Hz	
Leakage Current	-	-	0.75mA	277V/50Hz
Input AC Current	-	-	1.0A	100-277Vac & full load
Inrush Current(A)	-	-	75A	230Vac & full load
Power Factor	0.95	0.97	-	230Vac & full load
THD	-	-	20%	115-277Vac, 70%-100% load

OUTPUT SPECIFICATIONS

Parameter	Min.	Typ.	Max.	Notes
Output Current Tolerance	-5%Iset	-	5%Iset	Full load
Output Current Setting Range (Iset) LDP-075X054H LDP-075X141H LDP-075X270H	0.21A 0.11A 0.05A	-	2.10A 1.10A 0.53A	
Output Current Setting Range with Constant Power LDP-075X054H LDP-075X141H LDP-075X270H	1.40A 0.53A 0.28A	-	2.10A 1.10A 0.53A	
Total Output Current Ripple (pk-pk)		10%	16%Imax	230Vac & full Load · load is LED, ripple is different with difference LED load.
Startup Overshoot Current		-	10%	115~277Vac & 100% Load · load is LED
No Load Output Voltage LDP-075X054H LDP-075X141H LDP-075X270H	-	-	60V 160V 300V	
Line Regulation	-	-	1%	25°C±10°C ambient temperature, input voltage changes from 115Vac to 305Vac.
Load Regulation	-	-	3%	25°C±10°C ambient temperature, 230Vacinput, load changes from 50% to 100%.
Turn-on Delay Time			1S	230Vac,100% load
	-	-	3S	115Vac,100% load



LDP Series - 75W Outdoor Programmable Driver

GENERAL SPECIFICATIONS

Parameter	Min.	Typ.	Max.	Notes
Efficiency @115Vac LDP-075X054H $I_o=1.40A$ $I_o=2.10A$ LDP-075X141H $I_o=0.53A$ $I_o=1.10A$ LDP-075X270H $I_o=0.28A$ $I_o=0.53A$	82% 82% 82% 82% 82% 84%	84% 84% 84% 84% 84% 84%		Measured at full load and 25°C ambient temperature
Efficiency @230Vac LDP-075X054H $I_o=1.40A$ $I_o=2.10A$ LDP-075X141H $I_o=0.53A$ $I_o=1.10A$ LDP-075X270H $I_o=0.28A$ $I_o=0.53A$	85% 85% 85% 86% 85% 85%	87% 87% 87% 88% 87% 87%		Measured at full load and 25°C ambient temperature
Efficiency @277Vac LDP-075X054H $I_o=1.40A$ $I_o=2.10A$ LDP-075X141H $I_o=0.53A$ $I_o=1.10A$ LDP-075X270H $I_o=0.28A$ $I_o=0.53A$	85% 85% 85% 856% 85% 85%	87% 87% 87% 87% 87% 87%		Measured at full load and 25°C ambient temperature
MTBF	-	200000 hours	-	230Vac, 80% load (MIL-HDBK-217F)
Lifetime	-	50000 hours	-	230Vac & 100% load, 70°C case temperature, refer to lifetime VS Tc curve for details
Operating Case Temperature for Safety Tc_s	-	-	+85°C	
Operating Case Temperature for Warranty Tc_w	-40°C	-	+70°C	
Storage Temperature	-40°C	-	+85°C	Humidity: 20% to 95% RH
Dimensions (LxWxH)mm	164*68*39			
Net Weight	755±50g/PCS			
Package	L500*W310*H60mm; Gross Weight: about 8.65Kg; 10pcs/Ctn			

DIMMING

Parameter		Min.	Typ.	Max.	Notes
0~5V/0~10V Absolute Maximum Voltage on the Vdim (+) Pin		-	5V/10V	-	
0~5V/0~10V Source Current on Vdim (+) Pin		-	-	2mA	
Dimming Output Range	LDP-075X054H LDP-075X141H LDP-075X270H	10%Imax	-	100%Imax	Imax=2.10A Imax=1.10A Imax=0.53A
	LDP-075X054H LDP-075X141H LDP-075X270H	0.21A 0.11A 0.05A	-	2.10A 1.10A 0.53A	
	Recommended Dimming Range for 0-5 V				
Recommended Dimming Range for 0-10 V					Default 0-10V/10V PWM Dimming
PWM_in High Level		9.7V	-	10.3V	
PWM_in Low Level		0V	-	0.3V	
PWM_in Frequency Range		250Hz		1000Hz	
PWM_in Duty Cycle		1%	-	99%	

SAFTY STANDARDS

Safety Category	Country / Territory	Standards
CCC	China	GB19510.1
		GB19510.14
CE	Europe	EN61347-1
		EN61347-2-13
CB	CB Countries	IEC61347-1
		IEC61347-2-13
UL	USA	UL 8750
		UL 1310 (Class 2 Power Units)
		UL 1012
cUL	Canada	CSA C22.2 No.250.13-12
		CSA C22.2 No.223-M91 (Power Supplies With Extra-Low-Voltage Class 2 Outputs)
KC	South Korea	K61347-1
		K61347-2-13
		K62384
PSE	Japan	J61347-1
		J61347-2-13
SAA	Australia	AS/NZS IEC 61347-2-13
		AS/NZS 61347.1

EMC COMPLIANCE

EMC Category	Country / Territory	Standards
CCC	China	GB 17743
		GB 17625.1
CE	Europe	EN 55015
		EN 61000-3-2
		EN 61000-3-3
		EN 61547
KC	South Korea	K61547
		K00015
PSE	Japan	J55015
FCC	USA	FCC part 15

NOTE:

This LED driver meets the EMI specifications above, but EMI performance of a luminaire that contains it depends also on the other devices connected to the driver and on the fixture itself.

INRUSH CURRENT WAVEFORM

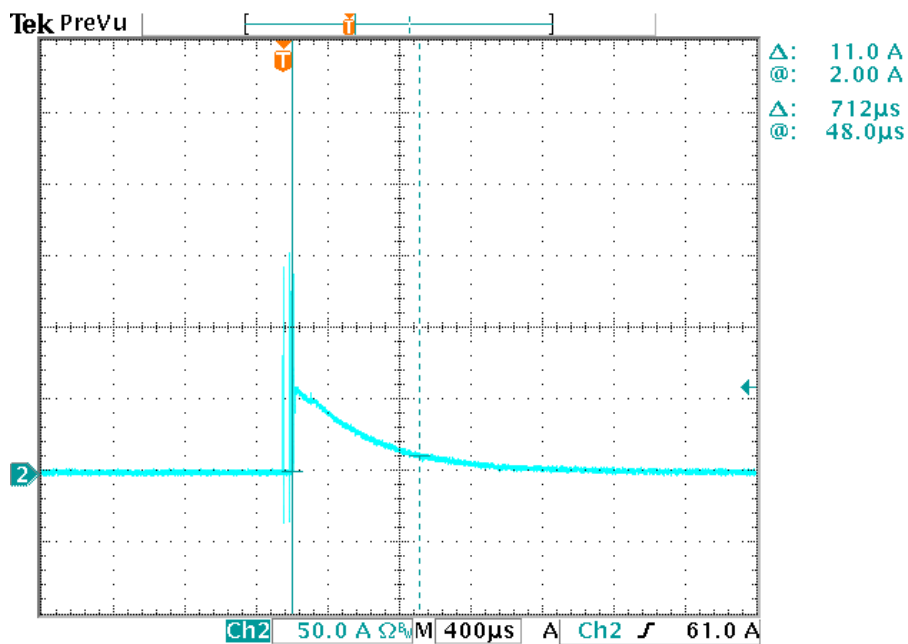

DERATING CURVE

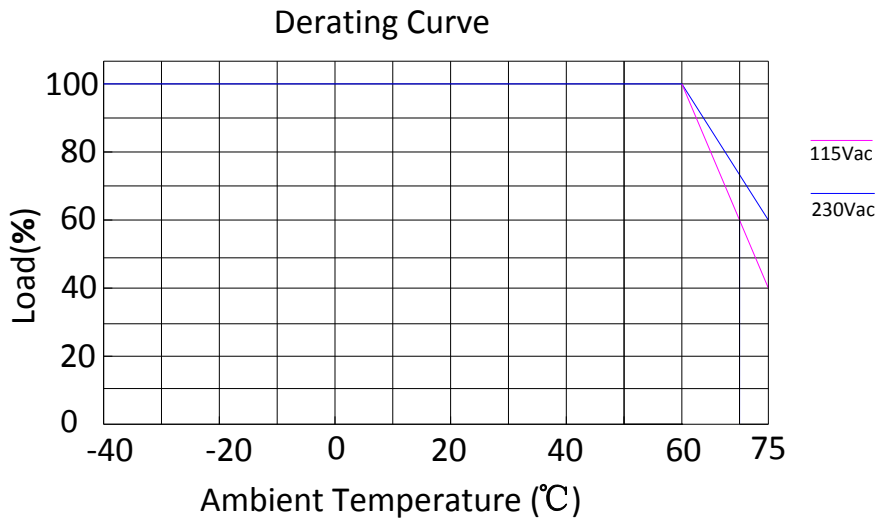

OUTPUT POWER VS INPUT VOLTAGE

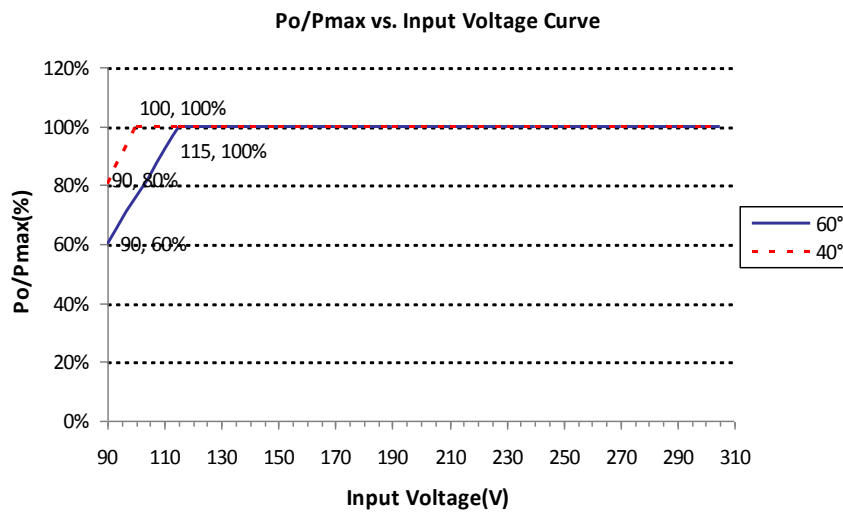

LIFETIME VS CASE TEMPERATURE

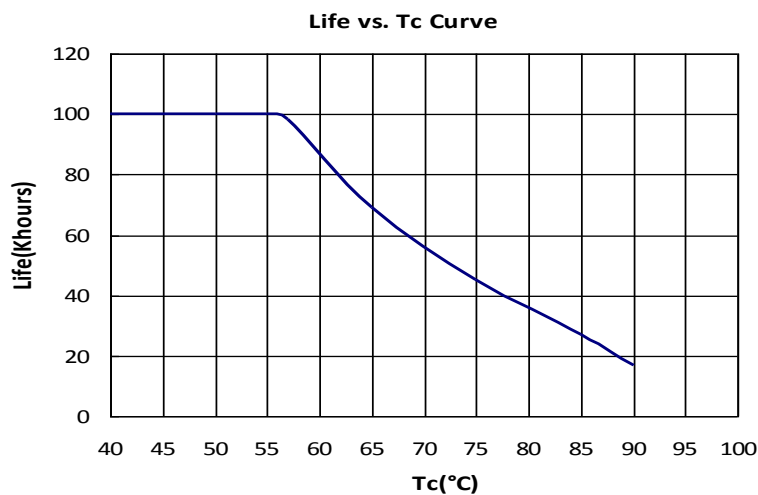

EFFICIENCY VS LOAD

LDP-075X054H(I=2.10A)

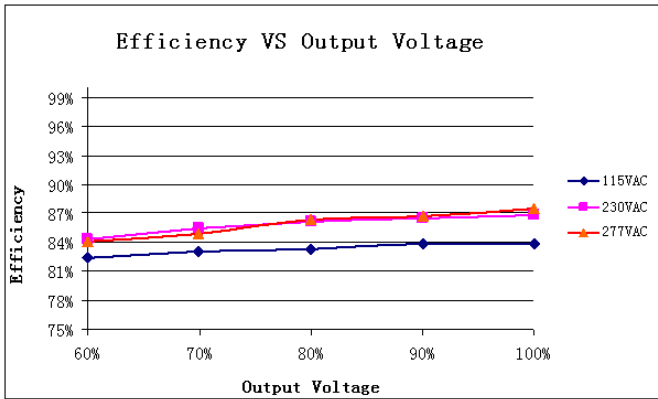

LDP-075X054H(I=1.39A)

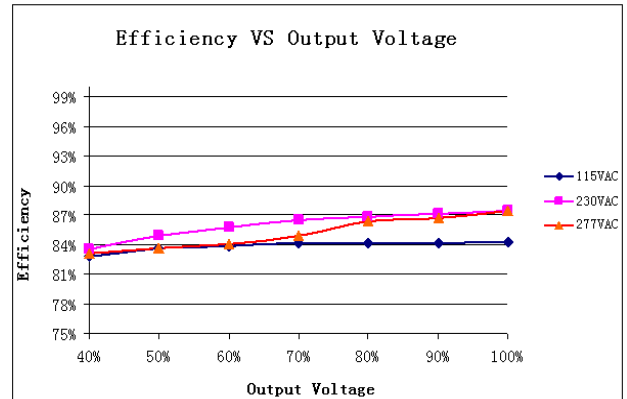

LDP-075X141H(I=1.10A)

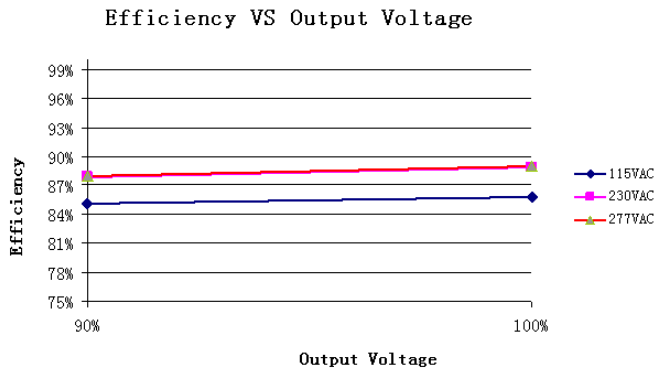

LDP-075X141H(I=0.53A)

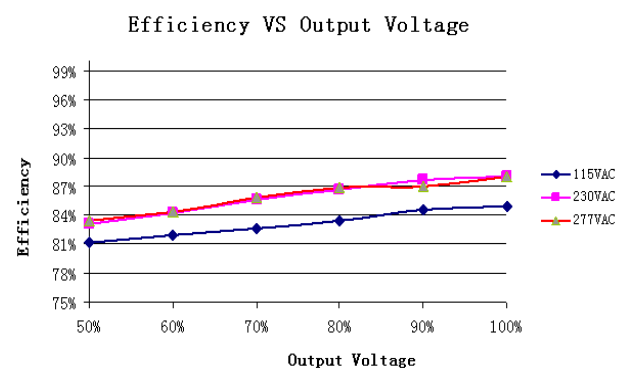

LDP-075X270H(I=0.53A)

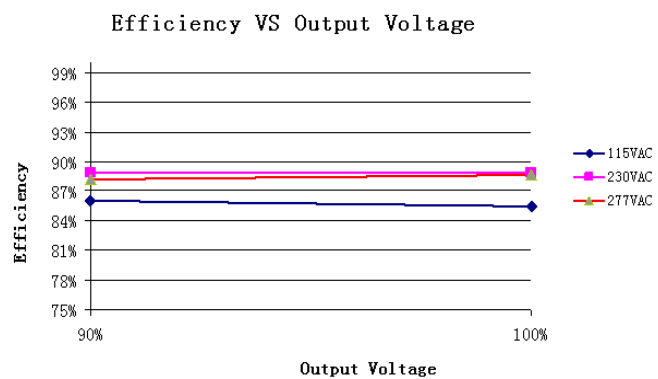

LDP-075X270H(I=0.28A)

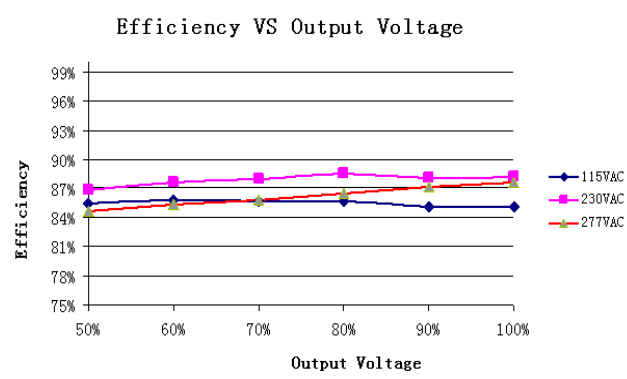

POWER FACTOR VS LOAD

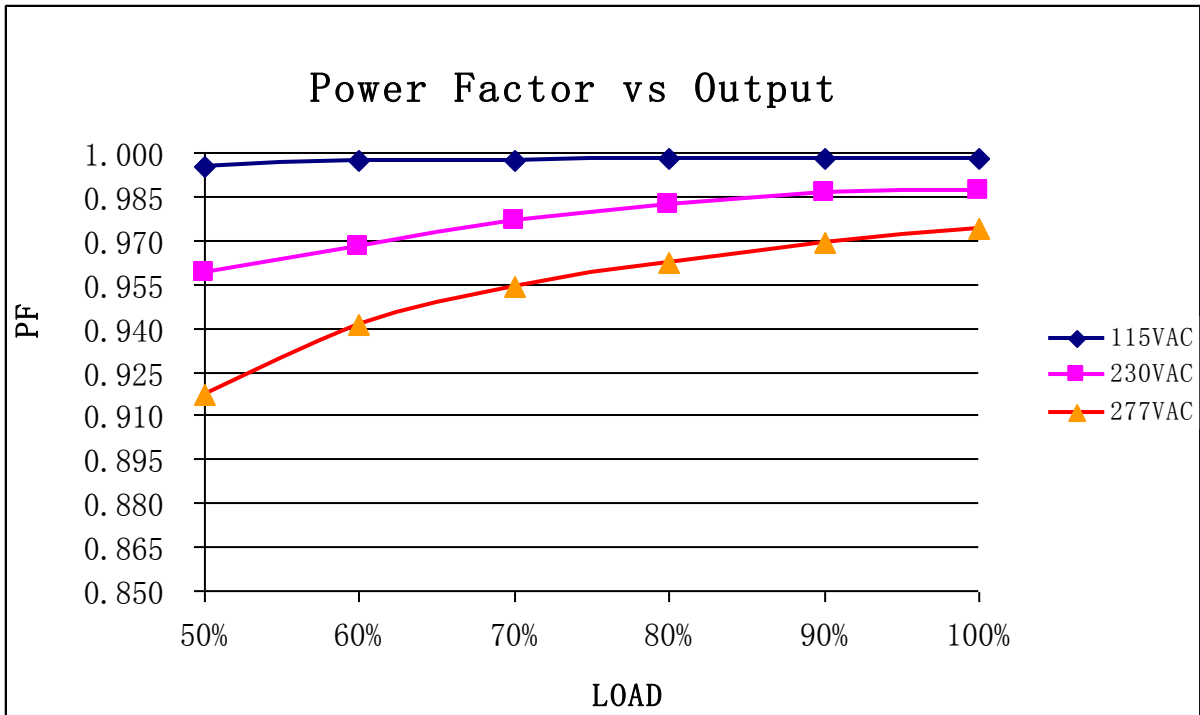

TOTAL HARMONIC DISTORTION

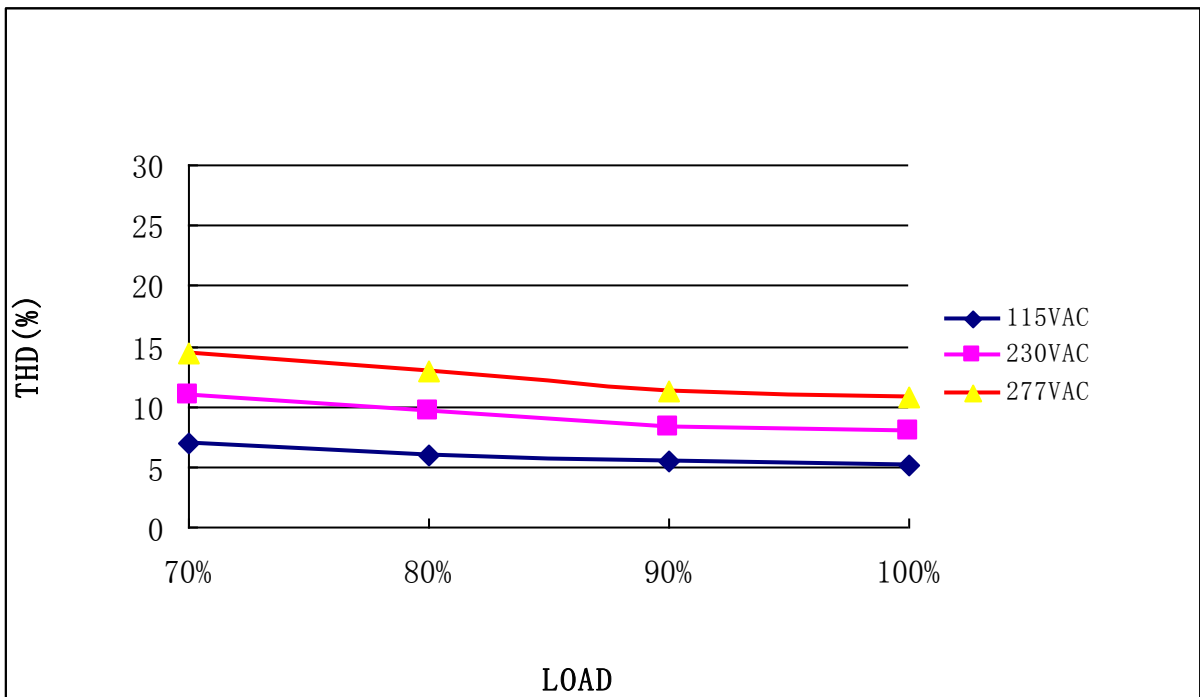

PROTECTIONS

Parameter	Notes
Over Temperature Protection	Decreases output current, returning to normal after over temperature is removed. The max derating could be 30% (typ.).
Short Circuit Protection	Hiccup mode and auto recovery. No damage will occur when any output is short circuited. The output shall return to normal when the fault condition is removed.
Over Voltage Protection	Run into protection model when output voltage exceeds limit, and return to normal when the fault

0-10 V/PWM DIMMING

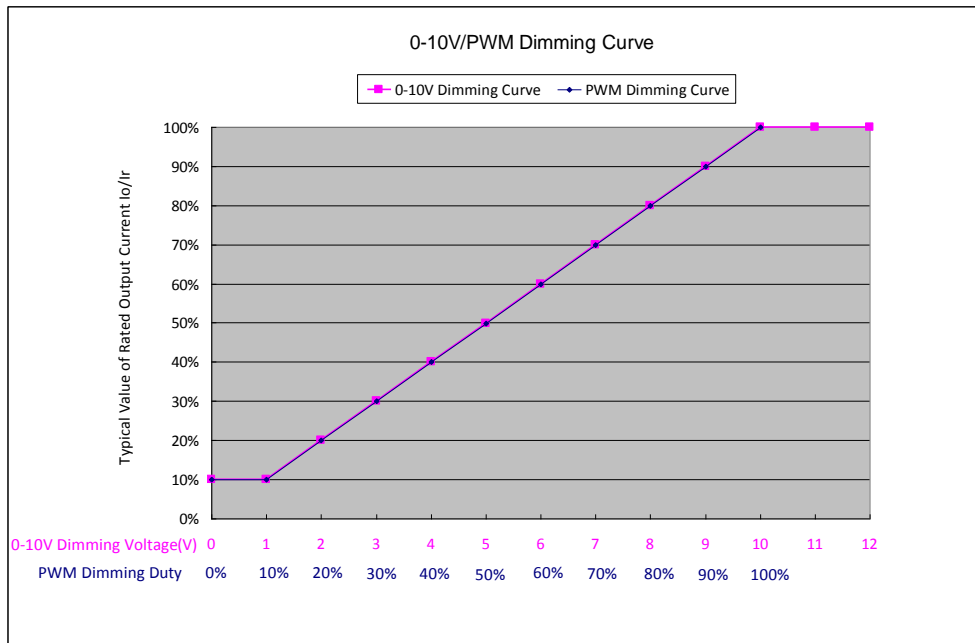

PROGRAMMING CONNECTION

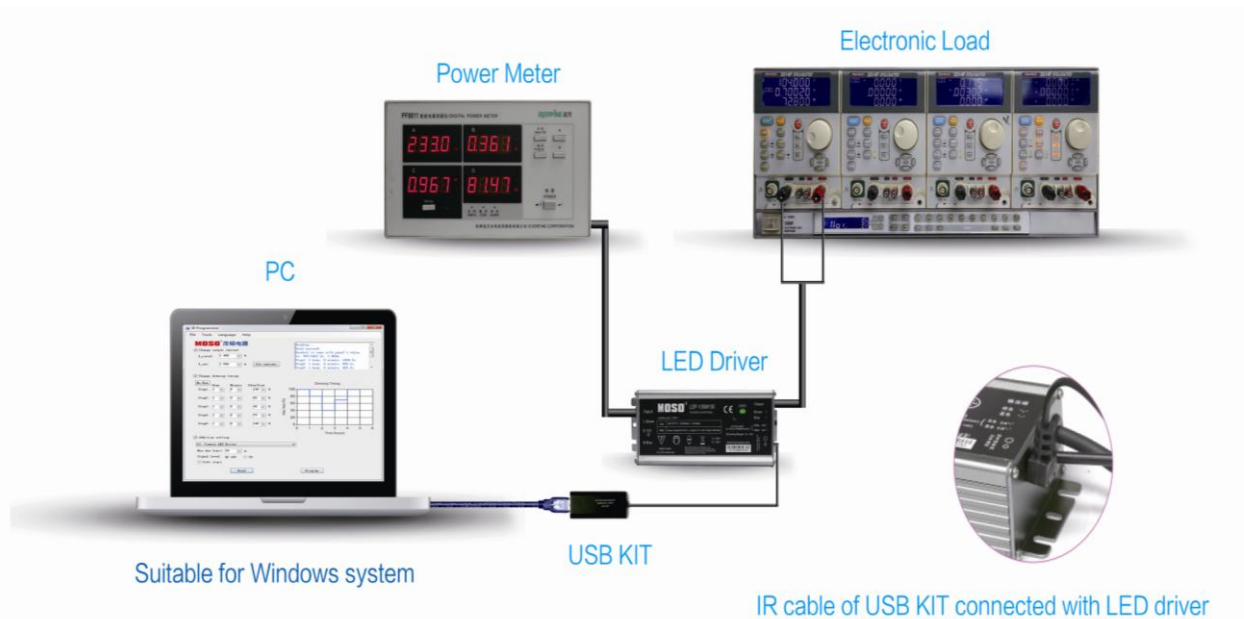

PROGRAMMING GUIDE AND SOFTWARE INTERFACE

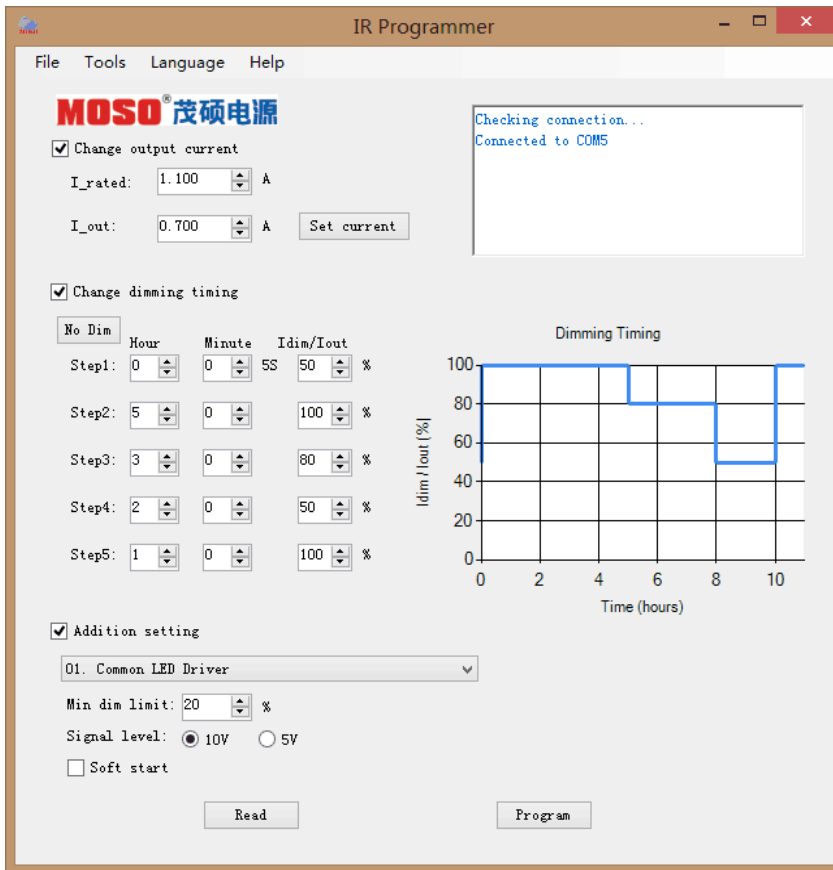

Programming by Software:

- 1) Read existing setting of the driver
- 2) Change output current;
- 3) Set timer dimming schedules;
- 4) Addition setting
 - Set min. dim value;
 - Set signal level can be 5V or 10V;
 - Set soft start.

USING INFRARED CONTROLLER TO RESET OUTPUT CURRENT



Operation Instruction:

- 1) Insert cable terminal of the infrared controller into the infrared communication port, which is at the DC output side of the LED driver.
- 2) Press "ON" key to power on the controller;
- 3) Within 10S interval, press a function key to adjust output current to the percentage of max delivered current;
 - 10%-100%: Percentage of maximum output current of such driver.
 - + / - : Fine adjustment of output current, increase / decrease 1% each time.
 - ON: Power on controller.
 - OFF: Set min output current of such driver.
 - SE: No function.

Warning:

- Please do not hold "+" key, to avoid the over power protection and unstable output.
- Each step of operation should be done within 10S interval, otherwise the controller is power off automatically.

MECHANICAL OUTLINE

LDP-075M types

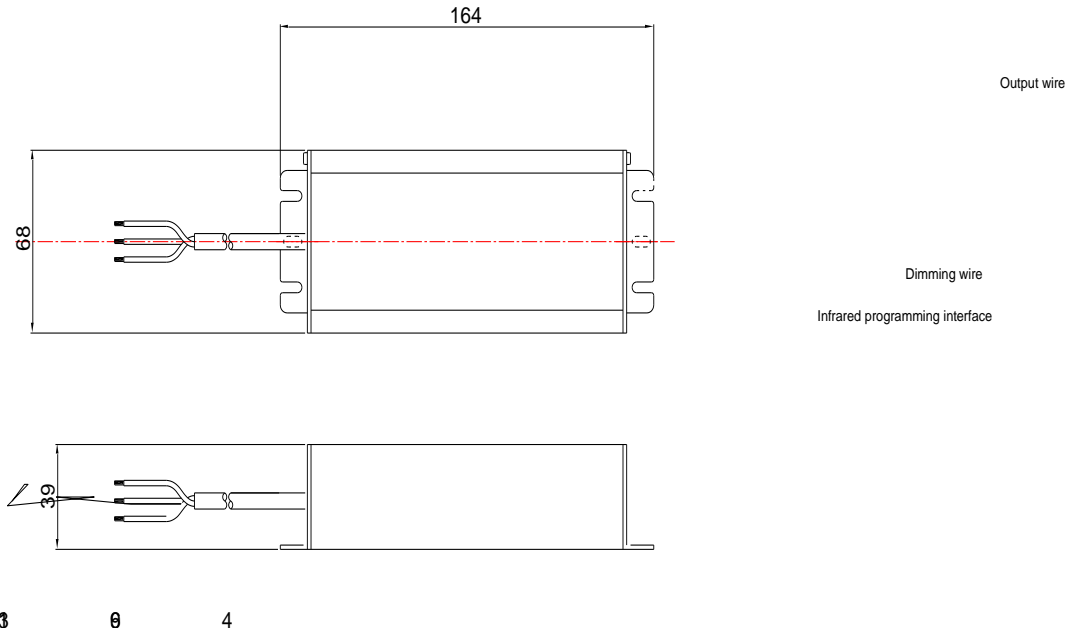

LDP-075R types

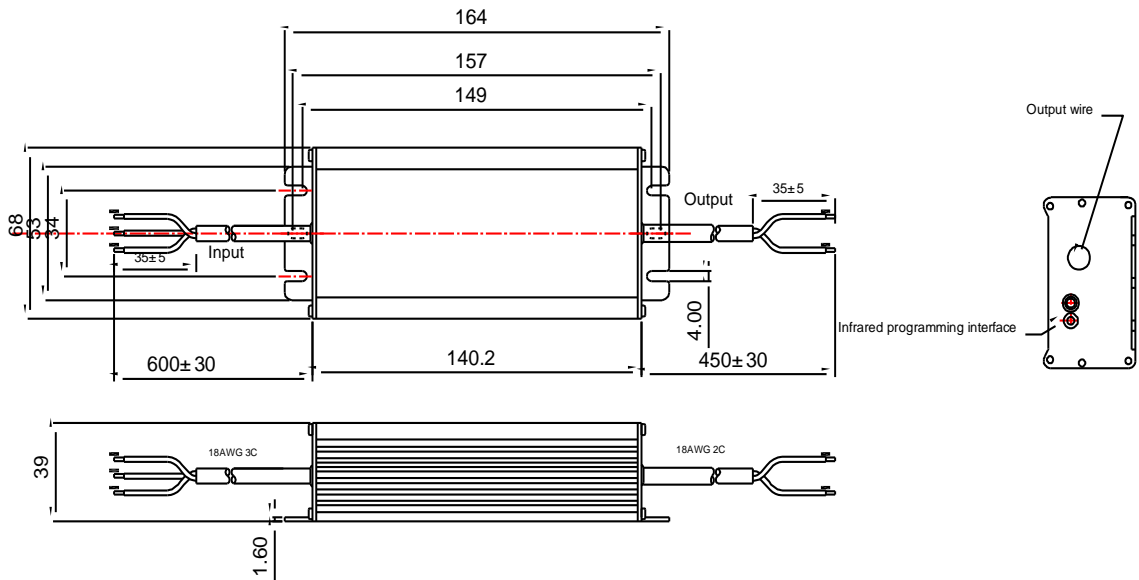



REVISION HISTORY

Version	Description of Change		Date	Notes
	Before	Now		
A.1	—	Datasheets Release	2017-10-17	