



ENGLISH

Datasheet

RS Pro Grey F2000 Control Panel Trunking DIN Halogen Free W75XH75

RS Stock No: 136-9171

The control panel trunking DIN halogen-free is manufactured with extrusion method and made of a blend of polycarbonate and ABS. It is then punched.

Properties:

Material:	PC/ ABS blend, free of halogen, silicon and cadmium (RoHS conform)		
Operation temperature:	static:	-25°C...+90°C (permanently)	
		-30°C...+110°C (briefly)	
	dynamic:	-5°C...+60°C	
Processing temperature:	>0°C		
Fire behaviour:	hard to inflame	DIN 4102	Level B1
	self-extinguishing	UL94	V0
	flammability class	DIN 5510-2	S4
	flammability class	NF F 16-101	M1
	smoke emission classification	DIN 5510-2	SR2
	smoke emission	EN ISO 5656-2	D _{s,max} = 40 (HL3)
	drop-ability class	DIN 5510-2	ST2
	flue gas density and toxicity	NF F 16-101	F2
	toxicity	NF X 70-100	CIT = 0,09 (HL3)
	oxygen index	ISO 4589-2	30,6% (HL2)
	fire load		5,2 kWh/kg
Classification	according to DIN EN 45545-2 (R22/R23) by total	Hazard Level 2 (HL2)	
Dielectric strength:	>30kV/mm		
UV- resistance:	PC/ ABS blend is partly UV- resistant, colour changes in case of UV- exposure cannot be excluded		
Colour:	RAL 7035 grey		
Delivery lengths:	2 m incl. cover		

Specific Features:

- cover contour 90°
- cable hold- back noses from installation height 75 mm onwards
- slid width 7,5 mm; slot width 5 mm
- notch points at the slids and base of trunking
- perforated base according to DIN 50085-2-3, identical punch picture for each length
- 3- lane perforated base from width 75 mm upwards
- for accessories and further information please visit our homepage www.licatec.de

Datasheet

Dimensions:

DIN- HF	Height (H) mm	Width (W) mm					
	25	25					
37,5	25	37,5	50				
50	25	37,5	50	75	100		
75	25	37,5	50	75	100	125	

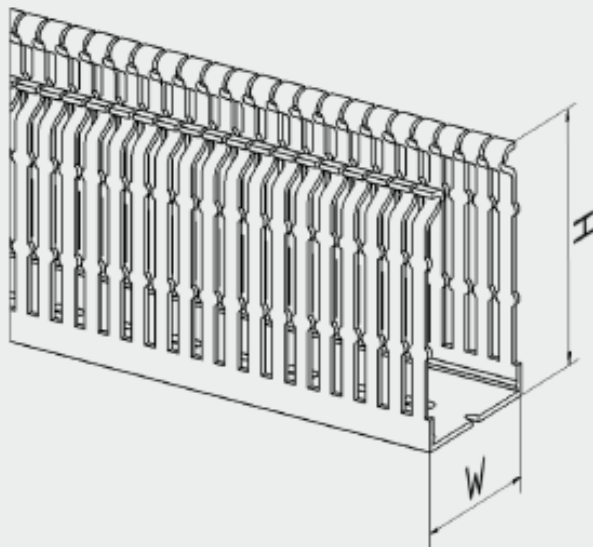

Width 75 upwards

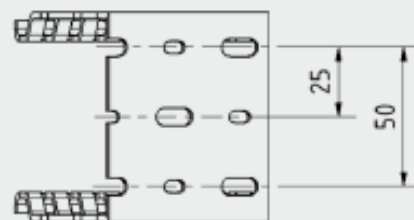

Up to width 50

