

Datasheet Insulated Terminal

RS Stock number [423-447](#)

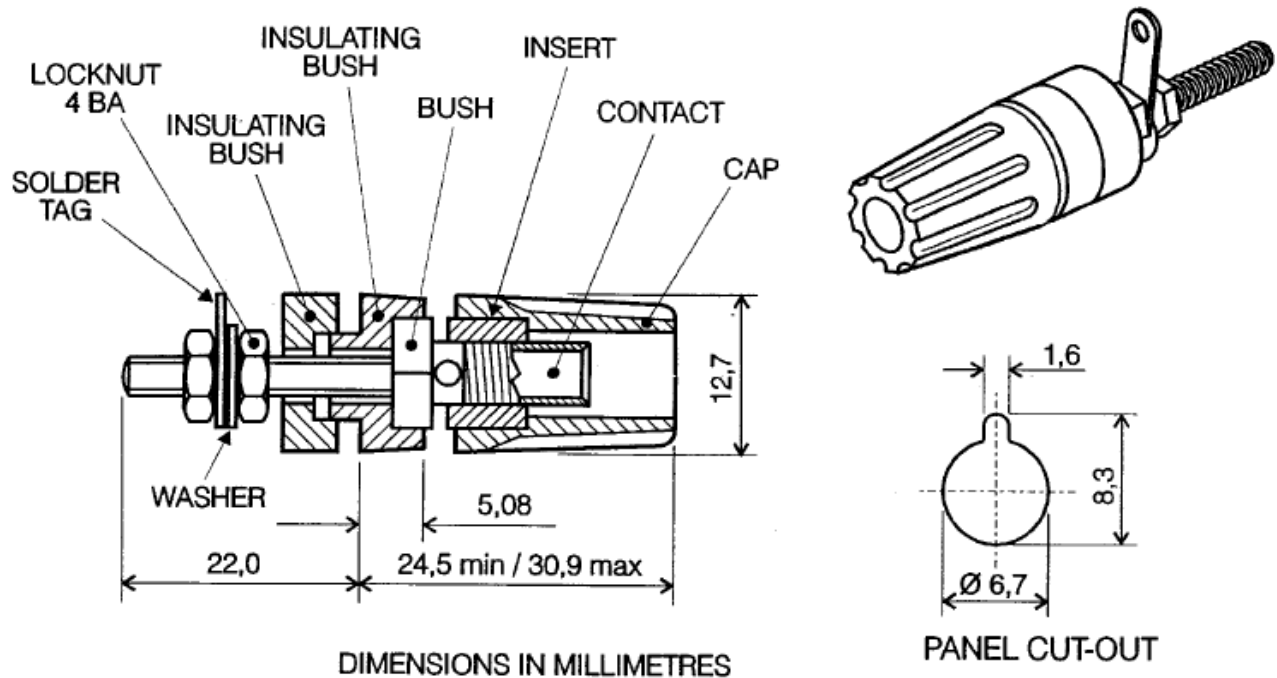

Description:

Insulated terminal binding post with a 4mm socket. Panel insulating bushes have a location keyway, maximum panel thickness 12,7mm. Threaded termination supplied with solder tag washer.

Colour	RS Stk No.
Black	423-201
Blue	423-217
Green	423-223
Red	423-239
Yellow	423-245
White	423-251
Brown	423-447

Specifications:

MATERIAL

CAP	Acetal
CONTACT	Brass, bright nickel plate
INSERT	Brass, bright nickel plate
BUSH	Brass, bright nickel plate
INSULATING BUSHES	Acetal
LOCKNUT	Brass, bright nickel plate
WASHER	Brass, bright nickel plate
SOLDER TAG	Brass, tin plate

Current Rating : 30 Amps at 1000 V