





Every part matters

EN

RS Pro IP67 6mm Push-Pull In-Line Connector Female 5 Pole

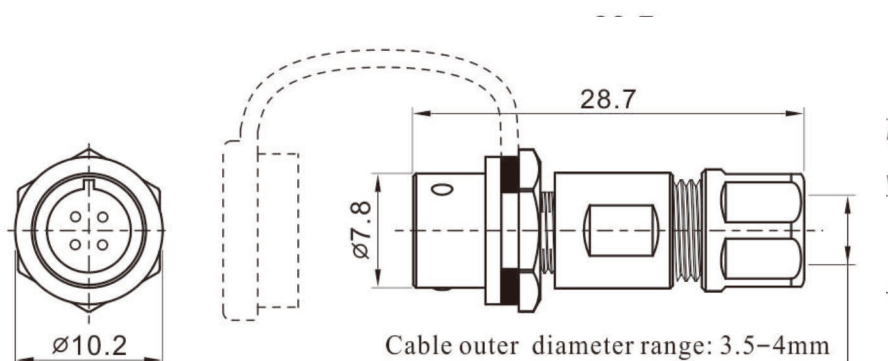
Stock Number: 188-9588



Male contact face view	
Rated current (A)	3
Contact diameter (mm)	0.6
Rated voltage (AC.V)	30
Test voltage(AC.V) 1 min	500
Contact resistance (mΩ)	10
Wire size (mm ² / AWG)	≤ 0.5/20