

FEATURES

- Industry standard symmetrical rail – 35mm x 7.5mm
- Un-Slotted Din-Rail 150mm length
- Steel mounting rail, hot-dip galvanized using the Sendzimir process
- Conforms to EN 60715

RS PRO, Din Rail, 150mm x 35mm x 7.5mm

RS Stock No.: 2258319



RS Professionally Approved Products bring to you professional quality parts across all product categories. Our product range has

Din-Rails

been tested by engineers and provides a comparable quality to the leading brands without paying a premium price.

Product Description

From the trusted RS PRO brand, a selection of robust TS-35 deep DIN rails used for mounting various electrical and industrial equipment. The TS-35 rail or Top Hat as it is also known is manufactured from Steel that is hot-dip galvanized using the Sendzimir process. Available in various lengths and slotted and un-slotted (perforated) profiles for easy attachment and wiring.

General Specifications

Compatibility	Top-Hat
DIN Rail Type	TS35
Applications	DIN rail terminal blocks, Power supplies, Plug in relays, Timer modules, Panel meters, I/O devices, Robotics, Automation and control devices

Mechanical Specifications

Material	Steel hot-dip galvanized using the Sendzimir process
Length	150 mm
Width	35 mm
Height	7.5 mm

Approvals

Standards Met	EN 60715
----------------------	----------

Similar Products

Stock No.	Brand	Product Name	Attribute 1	Attribute 2	Attribute 3

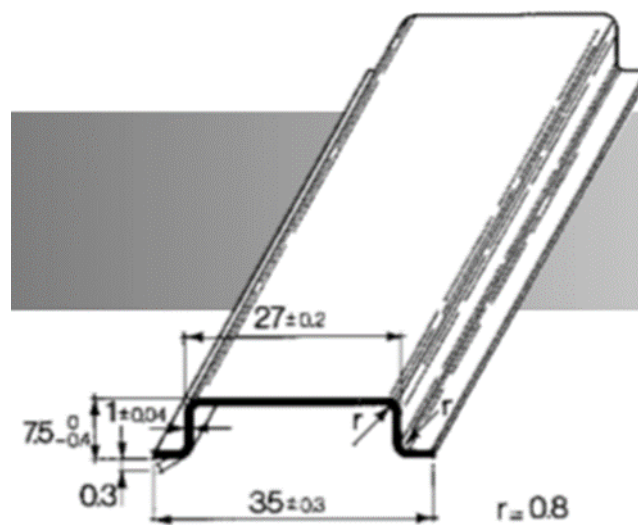

Connection Diagrams / Assembly Diagrams / Illustrations / Accessories