

Datasheet

Two spoke handwheel with fold down handle

RS Stock No: 1612010

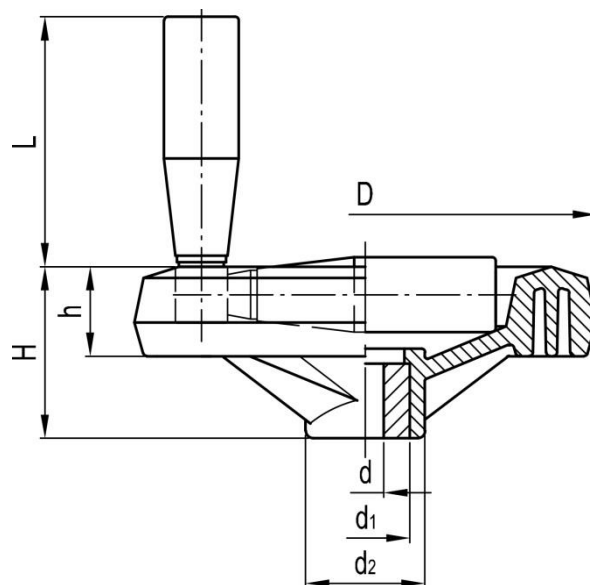

Specification

Handwheel material: Glass-fibre reinforced technopolymer

Fold-down handle material: Glass-fibre reinforced technopolymer

Zinc-plated steel hub, standard holes



ENGLISH

Stock no	D	d	H	h	d1	d2	L
1612001	80	8	35	18	18	24	46
1612002	80	10	35	18	18	24	46
1612003	100	10	37	20	18	24	46
1612004	100	12	37	20	18	24	46
1612005	126	10	46	24	24	32	65
1612006	126	12	46	24	24	32	65
1612007	126	14	46	24	24	32	65
1612009	126	15	46	24	24	32	65
1612010	160	10	52	26.5	26	40	65
1612011	160	12	52	26.5	26	40	65
1612012	160	14	52	26.5	26	40	65
1612013	160	16	52	26.5	26	40	65
1612015	200	10	62	28	30	50	75
1612016	200	16	62	28	30	50	75
1612017	200	20	62	28	30	50	75