

1625-2

Earth/Ground Tester

Users Manual

January 2014

© 2014 Fluke Corporation. All rights reserved. Specifications are subject to change without notice.
All product names are trademarks of their respective companies.

LIMITED WARRANTY AND LIMITATION OF LIABILITY

Each Fluke product is warranted to be free from defects in material and workmanship under normal use and service. The warranty period is two years and begins on the date of shipment. Parts, product repairs, and services are warranted for 90 days. This warranty extends only to the original buyer or end-user customer of a Fluke authorized reseller, and does not apply to fuses, disposable batteries, or to any product which, in Fluke's opinion, has been misused, altered, neglected, contaminated, or damaged by accident or abnormal conditions of operation or handling. Fluke warrants that software will operate substantially in accordance with its functional specifications for 90 days and that it has been properly recorded on non-defective media. Fluke does not warrant that software will be error free or operate without interruption.

Fluke authorized resellers shall extend this warranty on new and unused products to end-user customers only but have no authority to extend a greater or different warranty on behalf of Fluke. Warranty support is available only if product is purchased through a Fluke authorized sales outlet or Buyer has paid the applicable international price. Fluke reserves the right to invoice Buyer for importation costs of repair/replacement parts when product purchased in one country is submitted for repair in another country.

Fluke's warranty obligation is limited, at Fluke's option, to refund of the purchase price, free of charge repair, or replacement of a defective product which is returned to a Fluke authorized service center within the warranty period.

To obtain warranty service, contact your nearest Fluke authorized service center to obtain return authorization information, then send the product to that service center, with a description of the difficulty, postage and insurance prepaid (FOB Destination). Fluke assumes no risk for damage in transit. Following warranty repair, the product will be returned to Buyer, transportation prepaid (FOB Destination). If Fluke determines that failure was caused by neglect, misuse, contamination, alteration, accident, or abnormal condition of operation or handling, including overvoltage failures caused by use outside the product's specified rating, or normal wear and tear of mechanical components, Fluke will provide an estimate of repair costs and obtain authorization before commencing the work. Following repair, the product will be returned to the Buyer transportation prepaid and the Buyer will be billed for the repair and return transportation charges (FOB Shipping Point).

THIS WARRANTY IS BUYER'S SOLE AND EXCLUSIVE REMEDY AND IS IN LIEU OF ALL OTHER WARRANTIES, EXPRESS OR IMPLIED, INCLUDING BUT NOT LIMITED TO ANY IMPLIED WARRANTY OF MERCHANTABILITY OR FITNESS FOR A PARTICULAR PURPOSE. FLUKE SHALL NOT BE LIABLE FOR ANY SPECIAL, INDIRECT, INCIDENTAL OR CONSEQUENTIAL DAMAGES OR LOSSES, INCLUDING LOSS OF DATA, ARISING FROM ANY CAUSE OR THEORY.

Since some countries or states do not allow limitation of the term of an implied warranty, or exclusion or limitation of incidental or consequential damages, the limitations and exclusions of this warranty may not apply to every buyer. If any provision of this Warranty is held invalid or unenforceable by a court or other decision-maker of competent jurisdiction, such holding will not affect the validity or enforceability of any other provision.

Fluke Corporation
P.O. Box 9090
Everett, WA 98206-9090
U.S.A.

Fluke Europe B.V.
P.O. Box 1186
5602 BD Eindhoven
The Netherlands

11/99

To register your product online, visit register.fluke.com.

Table of Contents

Title	Page
Introduction	1
How to Contact Fluke	2
Safety Information	3
Storage	4
Models and Accessories	5
Additional Accessories	6
Features	7
Display	9
Setup	13
Batteries	13
Description of Functions	15
Operation	16
Advanced Operation	16
Power On Functions	16
Control Loop	17
Measurement Loop	19
Correct Measurement Connection (Socket Allocation) Check	19
Interference - Voltages and Frequencies Measurement	19
Earthing Resistances Measurement	20
3-Pole/4-Pole Measurement of Earthing Resistance	21
Measurement of Single Earth Electrode Resistances in Mesh Operated Earthing Systems Using Selective Clamp Method	23
3-Pole/4-Pole Measurement of Single Earth Electrode Resistances	24
Measurements on High Voltage Pylons	26
Clip-On Transformer Errors Correction	29
Compensation of Earth Electrode Connecting Lead	31
Measurement of Soil Resistivity	32
Measurement of Resistances	34
Resistance Measurement (R~)	34
Resistance Measurement (R \rightarrow)	35
Compensation of Measuring Lead Resistance	36
How to Change All Data Settings with Personalized CODE	37
Export Stored Data to PC	39
Delete Stored Data	40
Maintenance	41
Calibration	41
Service	41
Specifications	42

List of Tables

Table	Title	Page
1.	Symbols.....	4
2.	Models and Accessories	5
3.	Features and Functions.....	8
4.	Display Elements.....	9
5.	Display Descriptions	10
6.	Control Loop Parameters	18
7.	Data Settings	37
8.	Sample .CSV File for Logged Data	39
9.	Operational Error Calculation	43

List of Figures

Figure	Title	Page
1.	External Current Transformer EI-162BN	6
2.	Battery Insertion	14
3.	Method for Earthing Resistances Measurement	20
4.	3-Pole/4-Pole Measurement of Earthing Resistance - Process	21
5.	Measurement of Single Earth Electrode Resistances in Mesh Operated Earthing Systems	23
6.	3-Pole/4-Pole Measurement of Single Earth Electrode Resistances	24
7.	Earthing Resistance without Disengaging the Overhead Earth Wire	26
8.	Correcting Clip-on Transformer Errors	29
9.	Clip-on Transformer Connection	30
10.	Compensation of Earth Electrode Connecting Lead	31
11.	Measurement of Soil Resistivity	32
12.	Resistance Measurement (R_{\sim})	34
13.	Resistance Measurement ($R_{\overline{\sim}}$)	35
14.	Compensation of Measuring Lead Resistance	36

Introduction

The 1625-2 Earth Ground Tester (Tester or Product) is a compact, field-rugged instrument that performs all four types of earth ground measurement. Specifically, the Tester is able to measure earth ground loop resistances using only clamps – called Stakeless testing. This method doesn't require the use of earth ground stakes or the disconnection of ground rods.

The Tester features:

- One-button measurement concept
- 3-pole and 4-pole earth ground measurement
- 4-pole soil resistivity testing
- Selective testing, no disconnection of ground conductor (1 clamp)
- Stakeless testing, quick ground loop testing (2 clamps)
- Measuring frequency 94, 105, 111, 128 Hz

The Tester includes these advanced features:

- Automatic Frequency Control (AFC) – identifies existing interference and chooses a measurement frequency (94, 105, 111, 128 Hz) to minimize its effect, providing a more accurate earth ground value.
- R* measurement – calculates earth ground impedance at 55 Hz to more accurately reflect the earth ground resistance that a fault-to-earth ground would see.
- Adjustable limits – for quick test result verification.

At locations involving the generation, distribution and consumption of electrical energy, certain safety measures must be met in order to protect human life. In many cases, these safety measures are national and international regulations which must be checked regularly. Grounding, the connection of exposed conductive parts to the earth in case of a fault, represents the most fundamental safety measure. There are requirements for grounding of transformers, high and medium voltage power pylons, railway tracks, tanks, vats, foundations and lightning protection systems.

The effectiveness of grounding systems should be checked using a earth/ground tester such as the 1625-2 which checks the effectiveness of connections to the ground. The 1625-2 provides the perfect solution by combining the latest technology into a compact, field-rugged instrument. In addition to performing standard 3-pole and 4-pole ground resistance measurements, an innovative process accurately measures individual earth electrode resistances in single and meshed earthed systems without disconnecting any parallel electrodes. One specific application of this capability is quick and accurate measurement of power pylon grounds. The 1625-2 has automatic frequency control (AFC) to minimize interference. Before measuring, the instrument identifies existing interference and selects a measurement frequency to minimize its effect.

Notes

- *The terms earth and earthing also refer to ground and grounding and is used interchangeably throughout this manual.*
- *For stakeless earth resistance measurements, the Selective/Stakeless Clamp Set (EI-1623) must be purchased. (The 1625-2 Kit includes this clamp set.)*
- *Selective measurements are described in the main section of this manual.*

How to Contact Fluke

To contact Fluke, use one of these telephone numbers:

- USA: 1-800-760-4523
- Canada: 1-800-36-FLUKE (1-800-363-5853)
- Europe: +31 402-675-200
- Japan: +81-3-6714-3114
- Singapore: +65-6799-5566
- Anywhere in the world: +1-425-446-5500

Or, visit Fluke's website at www.fluke.com.

Go to www.fluke.com to register your product, download manuals, and find more information.

To view, print, or download the latest manual supplement, visit <http://us.fluke.com/usen/support/manuals>.

Safety Information

A **Warning** identifies hazardous conditions and procedures that are dangerous to the user. A **Caution** identifies conditions and procedures that can cause damage to the Product or the equipment under test.







⚠⚠ Warning

To prevent possible electrical shock, fire, or personal injury:

- Read all safety information before you use the Product.
- Use the Product only as specified, or the protection supplied by the Product can be compromised.
- Do not use the Product if it operates incorrectly.
- Do not use the Product if it is damaged.
- Do not use test leads if they are damaged. Examine the test leads for damaged insulation, exposed metal, or if the wear indicator shows. Check test lead continuity.
- Do not use the Product around explosive gas, vapor, or in damp or wet environments.
- Do not apply more than the rated voltage, between the terminals or between each terminal and earth ground.
- Use only current probes, test leads, and adapters supplied with the Product.
- Do not use a current measurement as an indication that a circuit is safe to touch. A voltage measurement is necessary to know if a circuit is hazardous.
- The battery door must be closed and locked before you operate the Product.
- Replace the batteries when the low battery indicator shows to prevent incorrect measurements.
- Do not connect directly to mains.
- Do not touch voltages >30 V ac rms, 42 V ac peak, or 60 V dc.

Table 1 is a list of symbols used on the Tester and in this manual.

Table 1. Symbols

Symbol	Description
	Risk of Danger. Important information. See Manual.
	Hazardous voltage. Risk of electrical shock.
	Battery Indicator
	Conforms to European Union directives.
	Conforms to relevant South Korean EMC Standards.
	Conforms to relevant Australian EMC requirements.
	This product complies with the WEEE Directive (2002/96/EC) marking requirements. The affixed label indicates that you must not discard this electrical/electronic product in domestic household waste. Product Category: With reference to the equipment types in the WEEE Directive Annex I, this product is classed as category 9 "Monitoring and Control Instrumentation" product. Do not dispose of this product as unsorted municipal waste. Go to Fluke's website for recycling information.

Storage

If the Tester is stored for an extended period of time or is not in use for a long time, you should remove the batteries.

Models and Accessories

These standard accessories were shipped with your Tester:

- 6 alkaline AA – type (LR6) batteries
- 2 measuring leads 1.5 m
- 1 connector cable (for RA 2-pole measurements)
- 2 alligator clips
- 1 Documentation CD with Users Manual
- Quick Reference Guide
- Safety Information

Table 2 is a list of the models and accessories.

Table 2. Models and Accessories

Description	Part Number
1625-2 Earth Ground Tester (Includes Users Manual, Safety Information, QRG, Geox Probe Cable, 2 clips, Lead set)	4325162
1625-2 Kit Earth Ground Tester Kit (Includes Users Manual, Safety Information, QRG, Geox Probe Cable, 2 clips, Lead set, 4 Earth Stakes, 3 Cable Reels, C1620 Carrying Case, EI-162X, EI-162AC)	4325181
162x-7001 Service Replacement Kit (Includes Lead set & 2 clips)	2577167
Earth Stake	4325492
ES-162P3-2 Stake Set for 3-Pole Measurement (Includes 3 Earth Stakes, 1 Cable Reel 25M Blue, 1 Cable Reel 50M Red)	4359377
ES-162P4-2 Stake Set for 4-Pole Measurement (Includes 4 Earth Stakes, 1 Cable Reel 25M Blue, 1 Cable Reel 25M Green, 1 Cable Reel 50M Red)	4359389
EI-1623 Selective/Stakeless Clamp Set for 1623-2/1625-2 (Includes EI-162X, EI-162AC)	2577115
EI-162X Clip-on Current Transformer (sensing) with shielded cable set	2577132
EI-162AC Clip-on Current Transformer (inducing)	2577144
EI-162BN Split Core Transformer - for Pylon Testing (12.7 inch - 320 mm)	2577159
Shielded Cable (Used w/ EI-162X Clamp)	2630254
Cable Reel, 25M, Blue wire	4343731
Cable Reel, 25M, Green wire	4343746
Cable Reel, 50M, Red wire	4343754
C1620 Carrying Case	4359042

Additional Accessories

An **external current transformer** is available as an option, see Figure 1. The transformer has a transformation ratio between 80 and 1200:1 for the measurement of a single branch in mesh-operated earthing systems. This enables the user to measure on high voltage pylons without separating the overhead earth wires or earth strips at the bottom of the pylons. It is also used to measure lightning protection systems without separating the individual lightning protection wires.

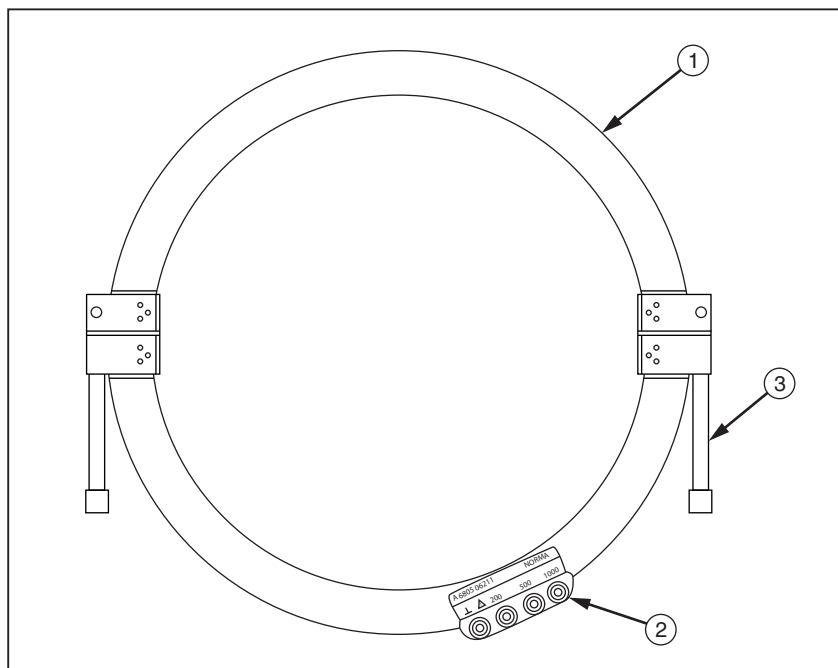

Figure 1. External Current Transformer EI-162BN

evx01.eps

- ① Transformer half (2)
Transformer end faces have bolts that pivot to aid in separating the Transformer halves. One Transformer end face has a slotted bolt hole that allows the bolt to pivot out of the end face.
- ② Transformation ratio connections: 1, 200, 500, and 1000
- ③ Fastener (2)

Features

The 1625-2 Earth/Ground Tester (Tester) is an earth resistance meter with fully automated measuring frequency selection process. The Tester includes automatic testing of probe and auxiliary earth electrode resistances and possible interference voltages in accordance with DIN IEC61557-5/EN61557-5:

- Measurement of interference voltage (U_{ST})
- Measurement of interference frequency (F_{ST})
- Measurement of probe resistance (R_S)
- Measurement of auxiliary earth electrode resistance (R_H)
- Measurement of earthing resistance 3-pole, 4-pole, (R_E) with or without using the external clip-on current transformer for selective measurement of single earthing branches in mesh operated earthing systems \gg
- Resistance measurement 2-pole with ac voltage (R_{\sim})
- Resistance measurement with dc voltage 2-pole, 4-pole, ($R_{\text{---}}$)

With its various possibilities of measurement and the fully automated measuring sequence control (incl. automatic frequency control AFC), this instrument offers the latest measuring technology in the field of earthing resistance measurements. By means of the selectable limit input with visual and acoustical confirmation/error message and with the code programmable and customer defined special functions, such as measuring voltage 20 V (for agricultural systems), earthing impedance R^* (measuring frequency 55 Hz) switched on or off, these instruments are individually programmable for use as a simple meter as well as a high end fully automated measuring device.

The Tester includes automatic testing of probe, auxiliary earth electrode resistances, and possible interference voltages.

See Table 3 for a list of features and functions.

Warning



- **No voltage permissible to sockets .**
- **Do not open or close the instrument with force.**
- **Disconnect all leads before opening the instrument.**

Table 3. Features and Functions

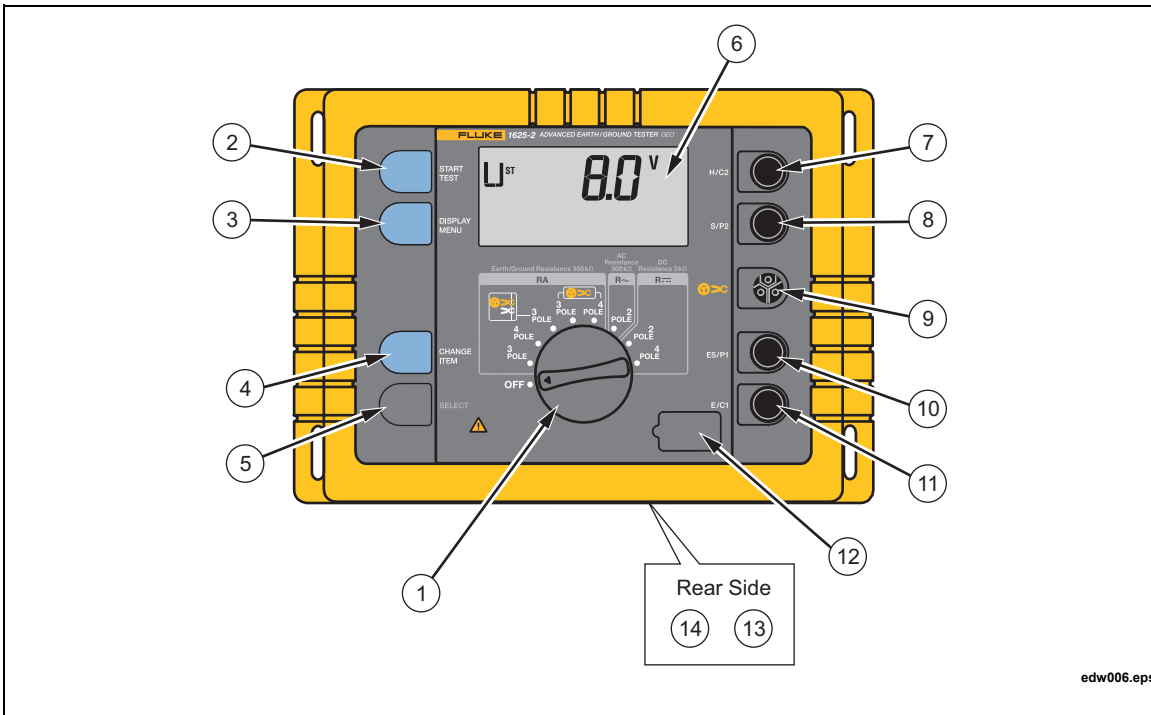

edw006.eps

No.	Description
①	Rotary switch to select measurement function and ON/OFF
②	"START TEST" button to start the selected measurement function
③	"DISPLAY MENU" button to select the setting or show test data
④	"CHANGE ITEM" button to change the selected setting value
⑤	"SELECT" button to confirm the setting value
⑥	Liquid crystal display (LCD)
⑦	Connection "H/C2" for auxiliary earth (4 mm \varnothing)
⑧	Connection "S/P2" for probe (4 mm \varnothing)
⑨	Connection  to sense current test clamp
⑩	Connection "ES/P1" for earth electrode probe (4 mm \varnothing)
⑪	Connection "E/C1" for the earth/ground electrode to be measured (4 mm \varnothing)
⑫	USB Type B Port
⑬	Battery compartment for 6 alkaline batteries (type AA, LR6)
⑭	Screws to fasten the battery compartment

Display

The display is a 4-digit (2999 Digit), 7 segment liquid crystal display (Table 4).

Table 4. Display Elements

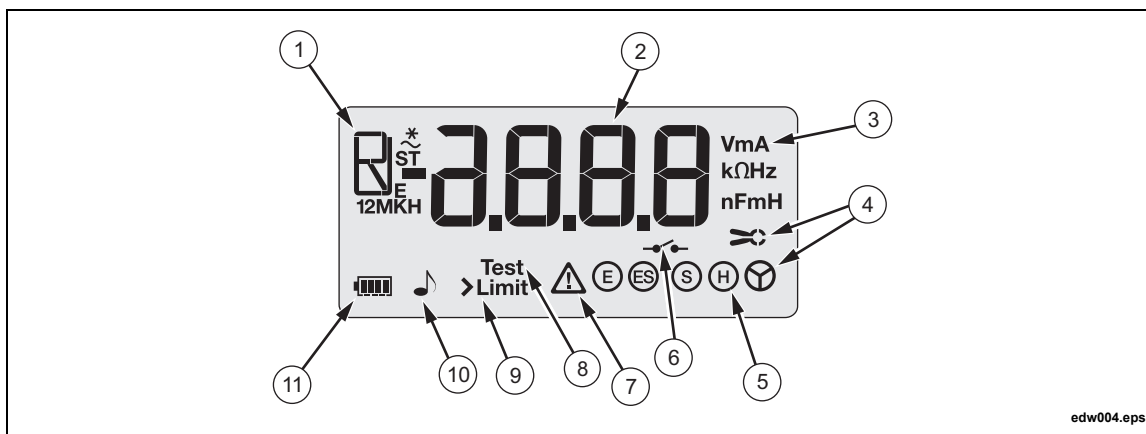

edw004.eps

Item	Description	
①	Test Type	
	U _{ST}	Interference voltage (AC + DC)
	F _{ST}	Frequency of interference voltage
	F _M	Frequency of measuring voltage
	U _M	Measuring voltage limit 20/48 V
	R _E	Earthing resistance
	R _H	Auxiliary earth electrode resistance
	R _S	Probe resistance
	R _K	Compensation resistance
	R ₁ , R ₂	Low voltage measurement with polarity indication
	R ~	AC- resistance
	R*	Earthing impedance (measuring frequency 55 Hz)
	②	Measurement
③	Measurement Unit: V, Ω, kΩ, Hz	
Symbols Key		
④	Recognition of current transformer socket	
⑤	Socket recognition	
⑥	Measuring circuit (E-S,E-H) interrupted or measured value unstable	
⑦	Error	
⑧	Measuring sequence in process	
⑨	Limit value/Limit value exceeded	
⑩	Warning for exceeded limit	
⑪	Battery level indicator	

Table 5 shows what you will see on the display as you operate the Tester.

Table 5. Display Descriptions





Function	Displays	Condition	Note
Before START	 edw027.eps	Stand by position to reduce power consumption	Turn rotary switch or push button. All measured values remain stored.
	 edw028.eps	No or incorrect measuring lead connection	Apart from voltage measurement, all measuring functions are locked.
	 edw030.eps	Beeper on	Acoustical warning if limit is exceeded.
	 edw031.eps	Dangerous ac voltage >50 V	Except a voltage measurement, all measuring functions are locked.
After "START"	 edw034.eps	Probe resistance is being tested	Wait for test result.

Table 5. Display Descriptions (cont.)



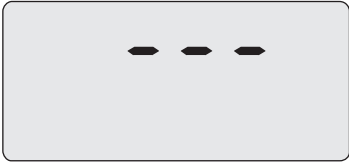

Function	Displays	Condition	Note
	 <p>edw035.eps</p>	Aux. current spike-resistance is being tested.	Wait for test result.
	 <p>edw036.eps</p>	Earth resistance is being tested.	Wait for test result.
	 <p>edw037.eps</p>	Measuring circuit of earth and auxiliary-earth electrode disconnected.	Check lead connection on earth spikes measuring lead might be defective.
	 <p>edw038.eps</p>	Measuring circuit of earth and probe electrode disconnected.	Check lead connection on earth spikes measuring lead might be defective.
	 <p>edw039.eps</p>	Maximum allowable error exceeded because of too high sense or aux earth spike resistance.	Try to moisten soil or connect 2nd aux earth spike in parallel.
After "START"	 <p>edw040.eps</p>	Measuring range exceeded.	Measured value is higher than 300 kΩ.
	 <p>edw041.eps</p>	Display of measured value exceeds LIMIT.	Measured value is higher than set LIMIT.

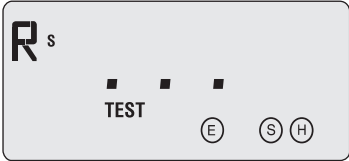
Table 5. Display Descriptions (cont.)



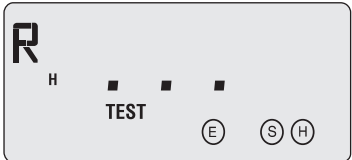
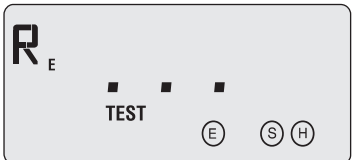

Function	Displays	Condition	Note
	 <p>edw042.eps</p>	Compensation higher than measured value.	Delete compensation or switch instrument ON/OFF.
	 <p>edw043.eps</p>	Wrong polarity on jacks E and ES.	Reverse polarity.
	 <p>edw044.eps</p>	Measured value unstable.	Unsteady noise voltage. Try time average measurement.
	 <p>edw045.eps</p>	Current in external transformer too low.	Reduce auxiliary current spike resistance.
	 <p>edw046.eps</p>	Operation under faulty conditions.	Check batteries. Switch ON/OFF if still faulty, contact service.
After "START"	 <p>edw047.eps</p>	Reverse orientation of current clamp or "upwards" current.	Reverse clamp.
	 <p>edw048.eps</p>	Checksum of EE PROM incorrect.	

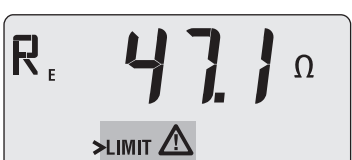
Table 5. Display Descriptions (cont.)

Function	Displays	Condition	Note
	 edw049.eps	Hardware malfunction (for example, current overload).	Switch ON/OFF if still faulty. The symbol may appear when using the stakeless measurement on low resistance circuits.
	 edw050.eps	EE PROM memory access malfunction.	Contact service.
	 edw051.eps	Internal computation malfunction.	
	 edw052.eps	Thermal overload.	Cool thoroughly.

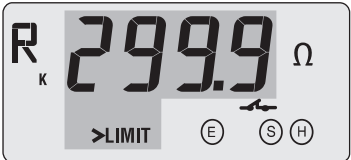
⚠ flashes on display

Setup

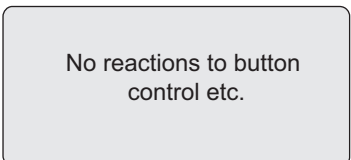
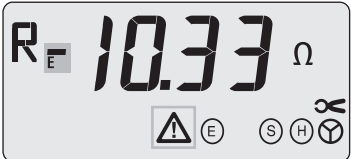
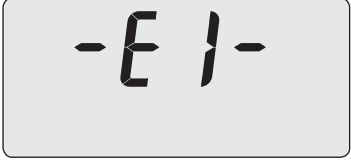
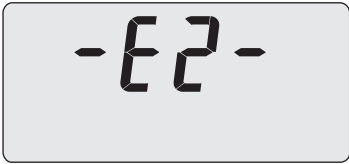
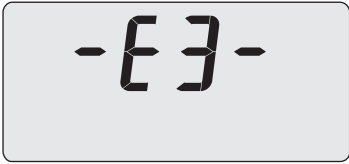
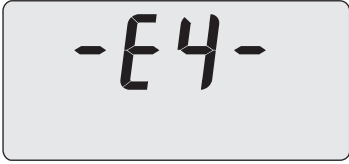
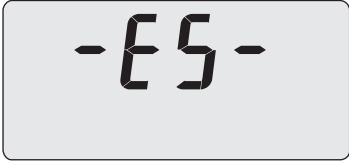
Batteries

Note

Rechargeable batteries may be used but must be charged outside of the instrument. The number of measurements available with these cells will typically be different to those available using alkaline cells.

This Tester is equipped with six 1.5 V batteries IEC LR6 type AA. Replace or recharge the batteries if the battery indicator shows 1 or 0 bars.

To insert the batteries:

1. Switch off instrument, see Figure 2.
2. Disconnect all test leads.
3. Open battery compartment.
4. Insert batteries. Always replace the complete set of batteries.
5. Close battery compartment.

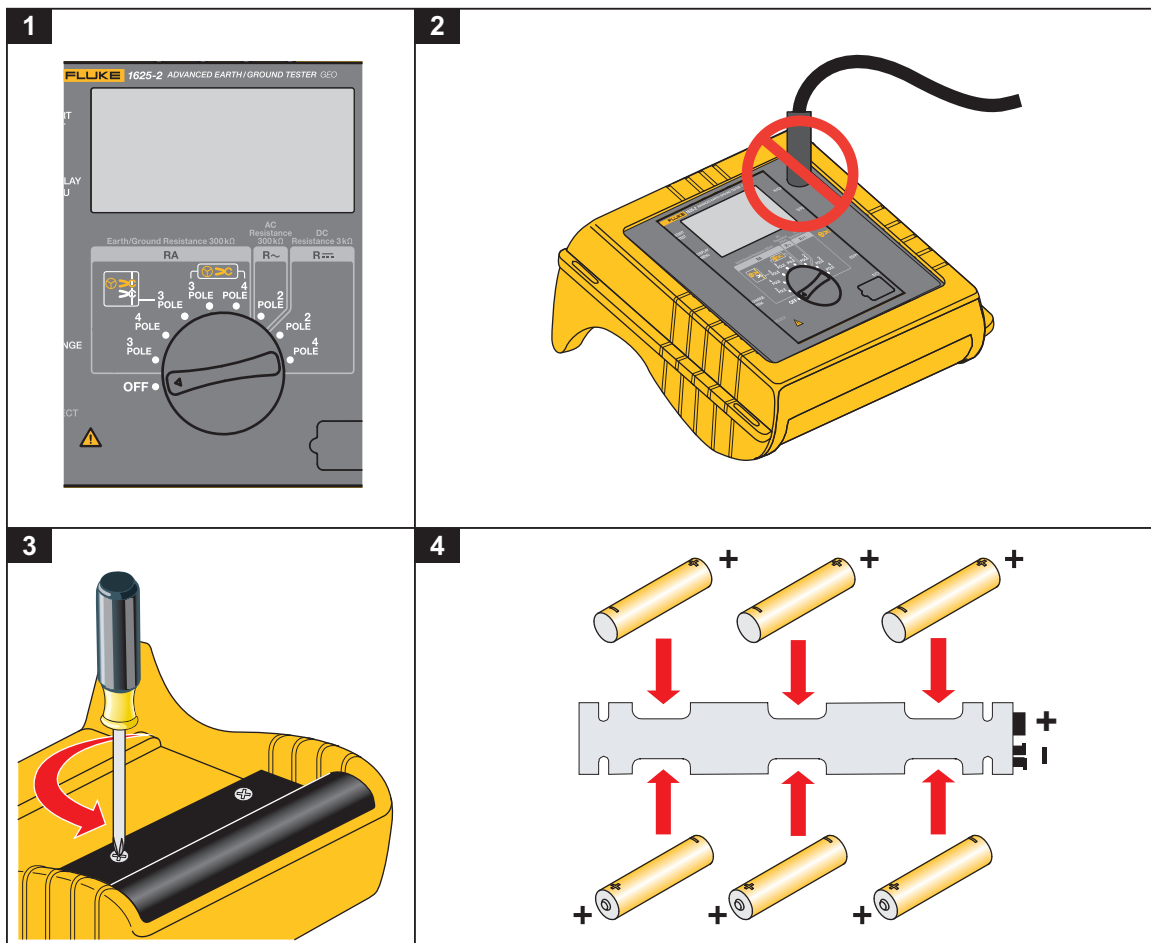

Figure 2. Battery Insertion

edw070.eps

⚠⚠ Warning

To prevent possible electrical shock, fire, or personal injury:

- The battery door must be closed and locked before you operate the Product.
- Replace the batteries when the low battery indicator shows to prevent incorrect measurements.
- Batteries contain hazardous chemicals that can cause burns or explode. If exposure to chemicals occurs, clean with water and get medical aid.

⚠ Warning

For safe operation of the Product:

- Repair the Product before use if the battery leaks.
- Be sure that the battery polarity is correct to prevent battery leakage.

Description of Functions

The functions are selected with the central rotary switch. Four push buttons start measurements, read out supplementary measurement values, and select special functions. See Table 6 for more information.

Measurement values are shown on a liquid crystal display with units. Additional special characters indicate measurement mode, operating condition and error messages.

The Tester includes these measurement functions:

- **Interference Voltage (U_{ST})** Fullwave rectification for dc and ac. If limit values are exceeded no measurement will be started.
- **Interference Frequency (F_{ST})** For interference voltage >1 V its frequency is derived from the period time.
- **Earthing Resistance (R_E)** The earthing resistance is determined by a 3-pole or 4-pole current and voltage measurement. The measuring voltage is a square pulse ac voltage with 48 / 20 V and a frequency of 94, 105, 111 or 128 Hz. The frequency can be selected manually or automatically (AFC). 55 Hz in function R*.
- **Selective Measurement of Earthing ($R_E \text{ } \text{>C}$)** Measurement of a single earth electrode in a mesh operated (parallel) earthing system. The current flowing through the single earth electrode is measured with an external current transformer.
- **Resistance (R_{\sim})** The resistance is determined by a 2-pole current and voltage measurement. The measuring voltage is a square pulse ac voltage with 20 V and a frequency of 94, 105, 111 or 128 Hz. The frequency can be selected manually or automatically (AFC).
- **Low Resistance ($R_{\text{---}}$)** The resistance is determined by dc current and voltage measurement. 2-pole as well as 4-pole measurement is possible. The short circuit current is > 200 mA. The resistance of both current directions is measured and stored.
- **Checking for Correct Measurement Connection** The Tester checks if the measuring lead is properly connected according to the selected function via isolated, two piece contacts, inside of each 4 mm (banana) input socket, in combination with detection circuitry. A wrong or missing connection is indicated by an optical and acoustical signal.
- **Beeper** The built-in beeper has two functions:
 - Send message if set limit values are exceeded.
 - Indicates dangerous condition or faulty operation.
- **Battery Level Indicator** A 4-segment battery level indicator shows the battery status.

Operation

Warning

To prevent possible electrical shock, fire, or personal injury, use the instrument on voltage free systems only.

1. Set measuring function with the central rotary switch.
2. Connect the measurement leads to the instrument.
3. Start measurement with "START TEST" button.
4. Read out measured value.

Advanced Operation

Power On Functions

At power on of the instrument with the central rotary switch, it is possible to access certain operating conditions by pressing specific button combinations:

a) Standard mode

If the device is put into operation without further button control, it switches into a battery saving condition (Stand by-display "---") approximately 50 seconds after the termination of a measurement, or after a button push or turn of the rotary switch. Pressing the "DISPLAY MENU" reactivates the instrument; the "old" measured values can be read out again. After 50 min. of stand by the Display is turned off completely. Instrument is reactivated with ON / OFF on the rotary switch

b) Stand by disable

A simultaneous push of buttons "DISPLAY MENU" and "CHANGE ITEM" at power on prevents the instrument from being switched off automatically (Stand by). The battery saving mode is reactivated with ON / OFF on the central rotary switch.

c) Prolonged display test

By keeping the "DISPLAY MENU" button pressed during power on, the display test can be prolonged for any length of time. Return to the standard operation mode by pressing any button or turning of the central rotary switch.

d) Number of software version

By keeping the "SELECT" button pressed during the power on sequence, the software version is indicated on the display. By pressing the "DISPLAY MENU" button a switch over to the last calibration date is possible. This display sequence is terminated by turning the central rotary switch or pressing the "START TEST" button.

Display format: SOFTWARE-version: X. X X

The measuring functions have two initial operational modes: the Control loop and the Measuring loop.

Control Loop

After turning the function rotary switch, the voltage display mode is reached. Pushing "DISPLAY MENU" now calls up the control loop. According to the selected measuring function, different setting values can be displayed and changed in the control loop. The "DISPLAY MENU" button switches between the different set values inside a continuous loop. The "SELECT" button selects the setting to be changed. Pushing the "CHANGE ITEM" button the instrument either switches between certain set values or increases the decimal point selected with "SELECT" by 1.

After parameter setting has been finished the next display can be called with "DISPLAY MENU" or the measurement can be started with "START TEST".

Depending on the selected function, the parameters can be shown or changed. See Table 6.

Table 6. Control Loop Parameters

Function	Parameter	Setting Range	Remarks
RE 3-pole and RE 4-pole	U ST		display only
	F ST		display only
	FM	(AFC/94/105/111/128) Hz	
	UM	48 V/20 V	selectable to 20 V with CODE
	RK	0.000 Ω ... 29.99 Ω	in position RE 3-pole only ^[1]
	RE LIMIT	0.000 Ω ... 999 kΩ	only if activated with CODE
	♪ (warning sound)	On/Off	is activated with CODE
	R ^[1]	On/Off	only if activated with CODE
RE	U ST		display only
	F ST		display only
☒	UM	48 V/20 V	selectable to 20 V with CODE
and RE 4-pole ☒	RK	0.000 Ω ... 29.99 Ω	in position RE 3-pole only ^[1]
	I (ratio)	80 ... 1200	display only
	RE LIMIT	0.000 Ω ... 999 kΩ	only if activated with CODE
	♪ (warning sound)	On / Off	only if RE LIMIT is activated with CODE
	R*	On / Off	only if activated with CODE
	U ST		display only
R~	F ST		display only
	FM	(AFC/94/105/111/128) Hz	
	RK	0.000 Ω ... 29.99 Ω	
	R ~ LIMIT	0.000 Ω ... 999 kΩ	only if activated with CODE
	♪ (warning sound)	On / Off	only if R ~ LIMIT is activated with CODE
R... 2-pole and 4-pole	U ST		display only
	F ST		display only
	RK	0.000 Ω ... 29.99 Ω	
	R LIMIT	0.000 Ω ... 9,99 kΩ	only if activated with CODE
	♪ (warning sound)	On / Off	only if R LIMIT is activated with CODE

[1] See Compensation of Earth Electrode Connecting Lead.

Measurement Loop

This loop is entered by pressing the "START TEST" button. After releasing "START TEST" the last measured value stays on the display. By repeated pressing of the "DISPLAY MENU" button all supplementary values can be called. If a measured value exceeds or falls below the pre-set limit, the limit can be displayed as well (with "DISPLAY MENU"). In that case the measured value is displayed with a flashing "LIMIT" whereas the limit value is displayed with a steady "LIMIT"-symbol.



Inside the measuring loop parameters cannot be changed.

Further possibilities of button operation:

Warning sound (🔊) cancel with "DISPLAY MENU" (with display switchover) or with "CHANGE ITEM" or "SELECT" button (without display switchover).

Correct Measurement Connection (Socket Allocation) Check

The instrument implements an automatic check, corresponding to the measurement selected, to see if the correct input sockets are used.

The display symbols  and  are assigned to a specific socket as shown in Figure 4.

From the way the symbols are displayed, the validity of the connected wiring can be concluded by the following features:

- socket incorrectly wired (or, by mistake, not wired): corresponding symbol flashes.
- socket correctly wired: corresponding symbol is steady active
- socket with no connection: corresponding symbol is blank

Interference - Voltages and Frequencies Measurement

This measuring function detects possible interference voltages and their frequencies. This function is automatically active in every switch position before an earthing or resistance measurement. If the pre-set limit values are exceeded, the interference voltage is indicated as too high and a measurement automatically prevented. The frequency of an interference voltage is only measurable if the level of this interference voltage is higher than 1 V.

Bring central rotary switch in desired position, read out measured value of interference voltage, measured value of interference frequency is displayed with "DISPLAY".

Earthing Resistances Measurement

This instrument is equipped with a 3-pole as well as a 4-pole resistance measurement that renders measurements of resistances of earthing systems possible, as well as measurements of the soil resistivity of geological strata. A specific description of the different applications is given further on in this manual. As a special function, the instrument offers measurements with an external current transformer, with which a measurement of single resistance branches in interlinked networks (lightning protection and high voltage pylons with cabling) can be performed without separating parts of the system. See Figure 3.

To ensure most feasible interference suppression during measurements, the instrument is equipped with four measuring frequencies (94 Hz, 105 Hz, 111 Hz, 128 Hz), with automatic switch over if necessary (AFC - Automatic Frequency Control). The corresponding measuring frequency used for a specific measurement can be called and displayed with DISPLAY MENU after the measurement. Additionally, one of the four measuring frequencies can be selected and permanently set in special cases. In that case, in order to stabilize the display, an average measurement can be carried out for up to 1 minute by keeping the START TEST button pressed.

To determine the earthing impedance (R^*) a measurement with a frequency close to the mains frequency (55 Hz) is carried out. At the activation of R^* through user's code, this measuring frequency is activated automatically.

To keep the instrument as simple as possible at the time of delivery, all special functions, such as LIMIT input, BEEPER programming, and measurement of earthing impedance (R^*) are not activated at delivery. They can be activated with personalized user's code (see *How to Change All Data Settings with Personalized CODE*).

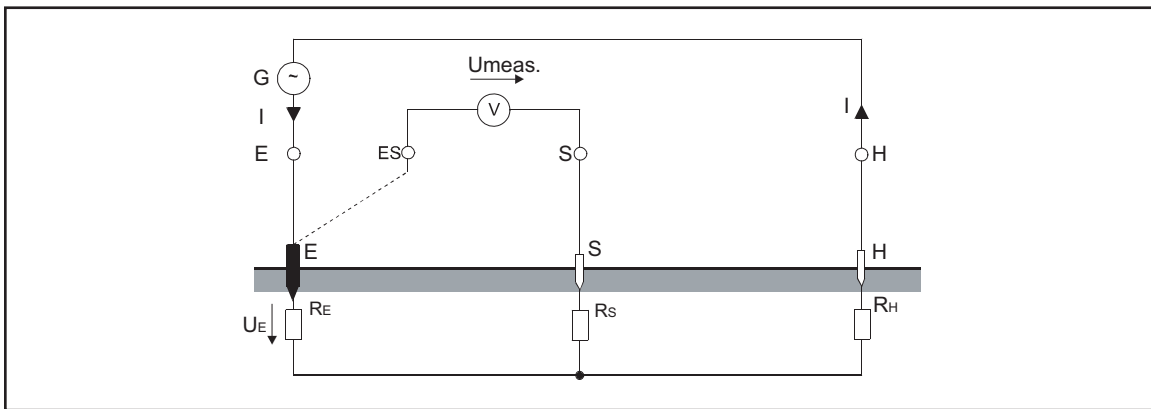

Figure 3. Method for Earthing Resistances Measurement

edw011.eps

3-Pole/4-Pole Measurement of Earthing Resistance

This measuring function measures earthing and earth dissipation resistances of single earth electrodes, foundation earth electrodes and other earthing systems by using two earth spikes. See Figure 4.

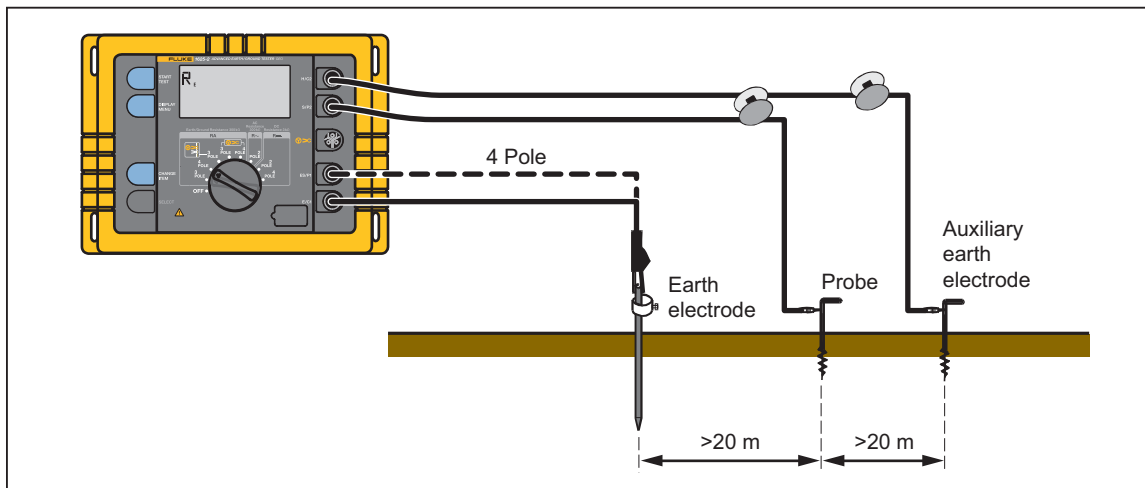

Figure 4. 3-Pole/4-Pole Measurement of Earthing Resistance - Process

edw012.eps

1. Turn central rotary switch to position "R_E 3pole" or "R_E 4pole"
The instrument is to be wired according to picture and notices given on the display.
A flashing of the sockets symbols E ES S H or >C , points to an incorrect or incomplete connection of the measuring lead.
2. Press "START TEST" button.
Now a fully automated test sequence of all relevant parameters like auxiliary earth electrode and probe and earth electrode resistance is implemented and finished with the display of the result R_E.
3. Read out measured value R_E.
4. Call R_S and R_H with "DISPLAY MENU".

Remarks for the setting of earth spikes:

Before setting the earth spikes for probe and auxiliary earth electrode make sure that the probe is set outside the potential gradient area of earth electrode and auxiliary earth electrode. Such a condition is normally reached by allowing a distance of >20 m between the earth electrode and the earth spikes as well as of the earth spikes to each other.

An accuracy test of the results is made with another measurement following repositioning of the auxiliary earth electrode or probe. If the value stays the same, the distance is sufficient. If the measured value changes, probe or auxiliary earth electrode must be repositioned until the measured value R_E stays constant.

Spike wires should not run too close to each other.

3-pole measurement with longer earth electrode connecting leads

Use one of the accessory cable drums as earth electrode connecting lead. Spool off cable completely and compensate line resistance as described in *Compensation of Earth Electrode Connecting Lead*.

Time average measurement:

If there is a warning, MEASURED VALUE UNSTABLE, (see Table 5) after a test sequence, most likely it is caused by strong interference signals, such as unsteady noise voltage. Nevertheless, to get reliable values, the instrument offers the possibility of averaging over a longer period.

1. Select a fixed frequency (see *Control Loop*).
2. Keep the "START TEST" button pressed until the warning "measured value unstable" disappears. Maximum averaging time is approximately 1 minute.

Measurement of Single Earth Electrode Resistances in Mesh Operated Earthing Systems Using Selective Clamp Method

This measuring method has been created to measure single earth electrodes in permanently wired or mesh-operated systems (for example, a lightning protection system with several electrodes or high voltage pylons with earth cabling). By measuring the actual current flow through the earth electrode, this special measuring method provides the unique possibility to measure selectively only this particular resistance by means of a clip-on transformer (accessory). See Figure 5. Other parallel resistances applied are not taken into account and do not distort the measuring result.

A disconnection of the earth electrode before the measurement is therefore no longer necessary.

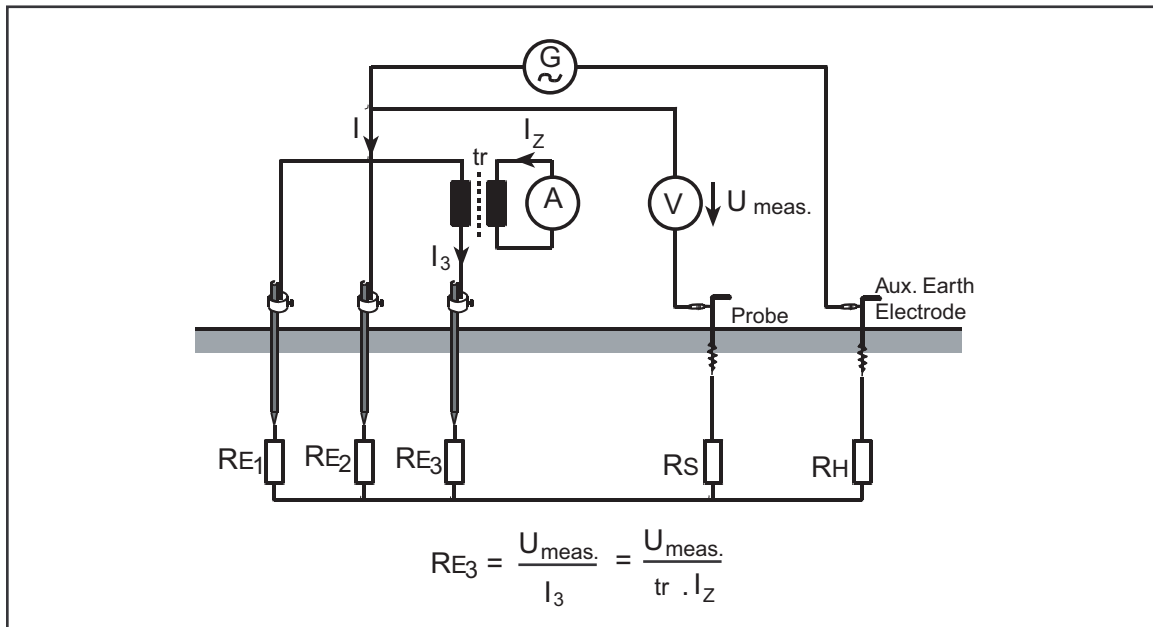

Figure 5. Measurement of Single Earth Electrode Resistances in Mesh Operated Earthing Systems

Errors of the current transformer can be corrected as described in *Clip-On Transformer Errors Correction*.

3-Pole/4-Pole Measurement of Single Earth Electrode Resistances

Turn central rotary switch to position " ∞ RE 3pole" or " ∞ RE 4pole". The instrument is to be wired according to Figure 6 and messages on the display.

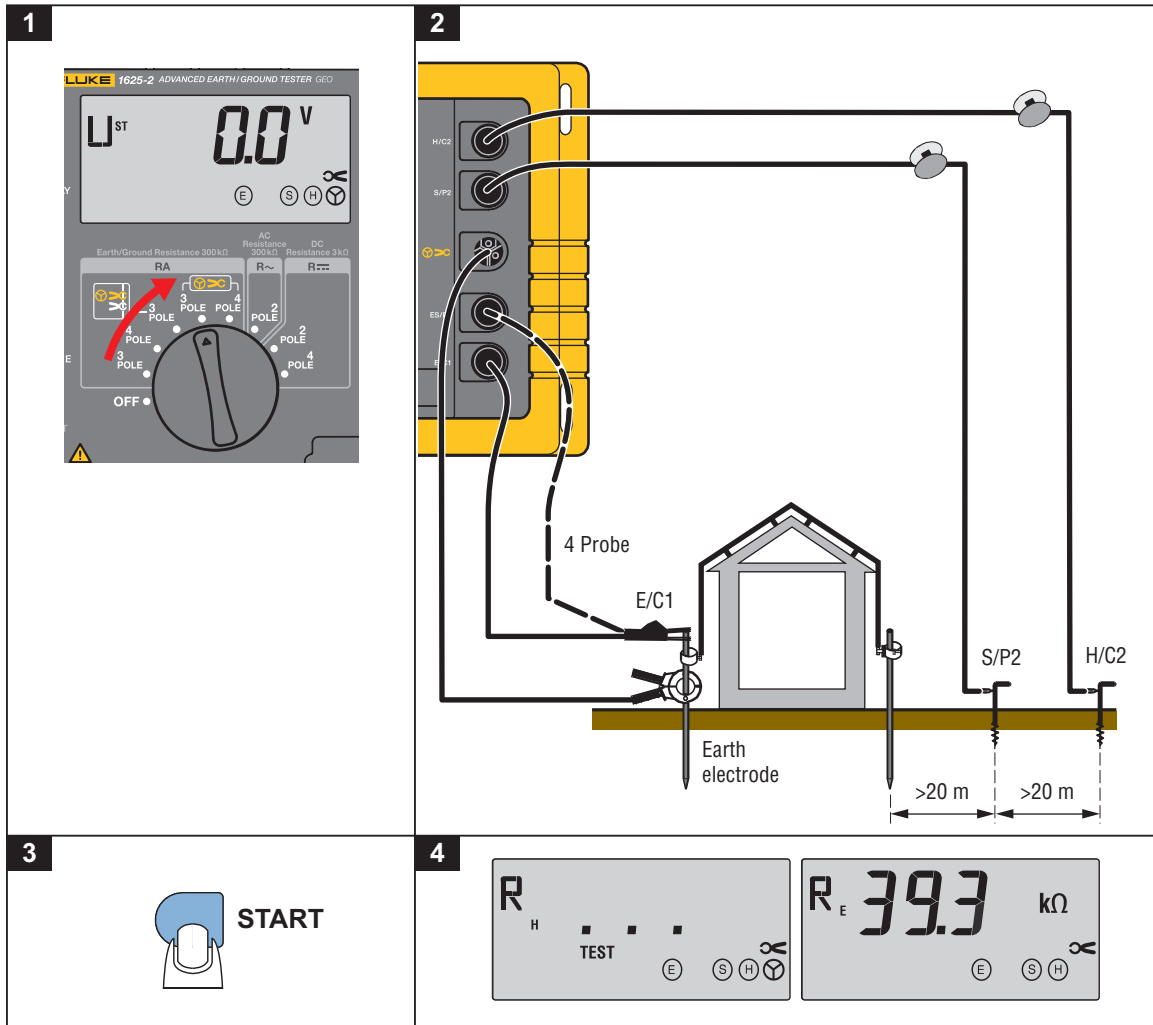

Figure 6. 3-Pole/4-Pole Measurement of Single Earth Electrode Resistances

edw015.eps

A flashing of the sockets symbols E S H or ∞ , points to an incorrect or incomplete connection of the measuring lead.

Fix clip-on transformer around the earth electrode to be measured.

Make sure that the clip-on transformation ratio set on the instrument corresponds to the clip-on transformer used. Change settings if necessary (see *How to Change All Data Settings with Personalized Code*).

Note

The ratio that is preset from factory is correct for the EI162X sensing clamp.

Press "START TEST" button.

Now a fully automated test sequence of all relevant parameters like auxiliary earth electrode and probe and earth electrode resistance is implemented and finished with the display of the result R_E .

1. Read out measured value R_E .
2. Call R_S and R_H with "DISPLAY MENU".

Remarks for the Setting of Earth Spikes

Before setting the earth spikes for probe and auxiliary earth electrode make sure that the probe is set outside the potential gradient of earth electrode and auxiliary earth electrode. Such a condition is normally reached by allowing a distance of >20 m between the earth electrode and the earth spikes as well as to the earth spikes to each other. An accuracy test of the results is made by another measurement following repositioning of the auxiliary earth electrode or probe. If the value stays the same, the distance is sufficient. If the measured value changes, probe or auxiliary earth electrode must be repositioned until the measured value R_E stays constant.

Spikes wires should not run too close.

3-pole Measurement with Longer Earth Electrode Connecting Leads

1. Use one of the accessory cable drums as earth electrode connecting lead.
2. Spool off cable completely and compensate line resistance as described in "Compensation of Earth Electrode Connecting Lead".

Time Average Measurement

If there is a warning "MEASURED VALUE UNSTABLE" (see Table 5) after a test sequence, most likely it is caused by strong interference signals (for example, unsteady noise voltage). To get reliable values, the instrument offers the possibility of averaging over a longer period.

1. Select a fixed frequency (see *Control Loop*).
2. Keep the "START TEST" button pressed until the warning "MEASURED VALUE UNSTABLE" disappears. Maximum averaging time is approximately 1 minute.

Measurements on High Voltage Pylons

Measuring the Earthing Resistance without Disengaging the Overhead Earth Wire Using the Selective Clamp Method

The measurement of the earth resistance of a single high voltage pylon usually requires the overhead earth wire to be disengaged (lifted off) or the separation of the earthing system from the pylon construction. Otherwise, false reading of the resistance of the pylon earth electrode are liable to occur because of the parallel circuit of the other pylons connected to each other by an overhead earth wire.

The new measuring method employed in this instrument - with its external current transformer to measure the true current flowing through the earth electrode - allows measurements of earth electrode resistances without disconnection of the earthing system or disengaging the overhead earth wire. See Figure 7.

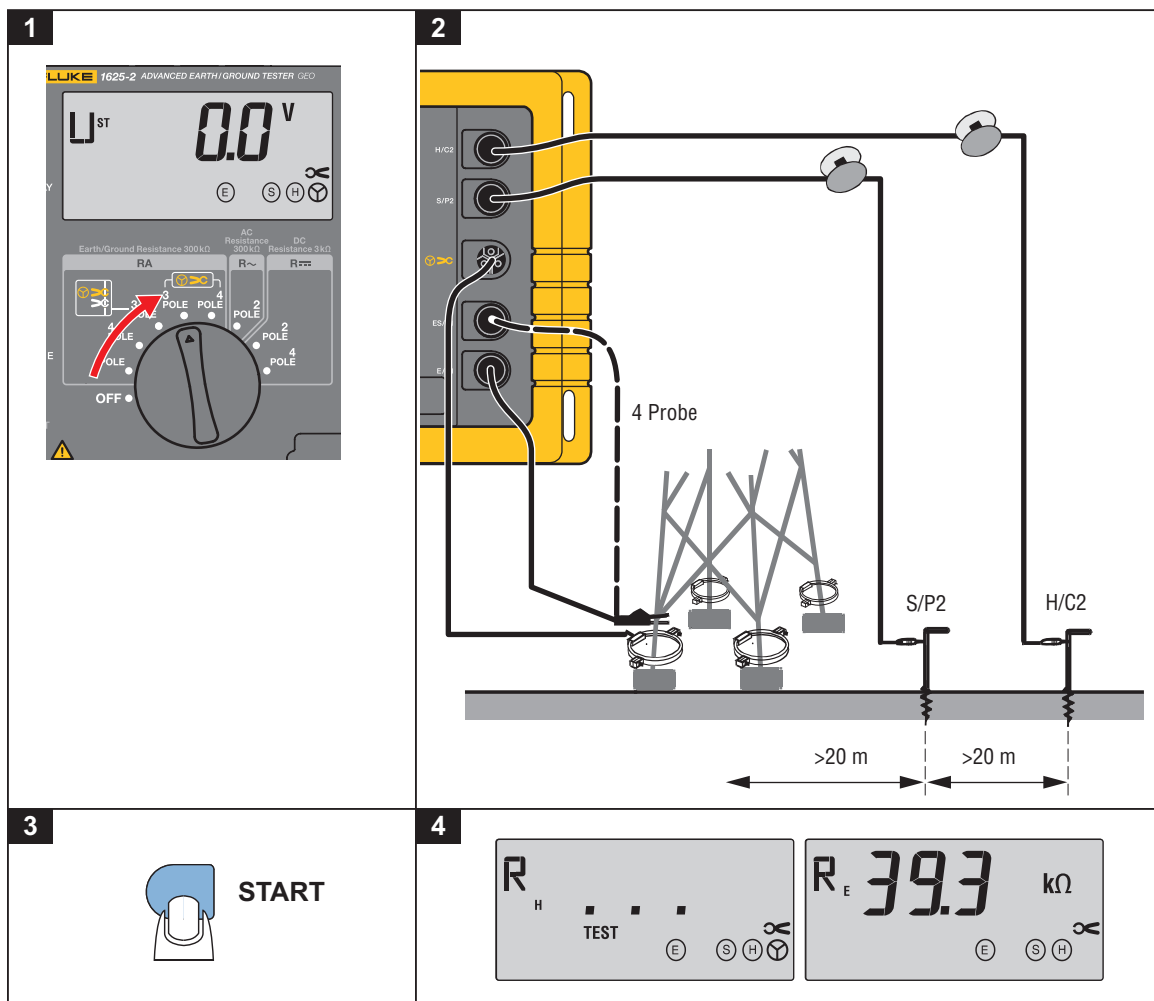

Figure 7. Earthing Resistance without Disengaging the Overhead Earth Wire

edw016.eps

As all four pylon stubs are connected to the foundation earth of the pylon, the measuring current I_{meas} is divided into five components according to the present resistances involved.

One part flows via pylon construction to the overhead earth wire and further to the parallel circuited pylon earthing resistances.

The other four current components ($I_1... I_4$) flow via each individual pylon foot.

The addition of all currents result in a current I_E going through the earthing resistance, for example, the resistance of the "composite" earth electrode to the soil.

If the current transformer is fixed to each pylon stub, one after the other, four resistances have to be measured which show a behavior inversely proportional to the corresponding current components $I_1 ... I_4$. The feeding point of the measuring current is to be left unchanged to avoid a change in the current distribution.

Accordingly, these equivalent resistances are displayed as:

$$R_{Ei} = \frac{U_{meas}}{I_i}$$

Therefore the earthing resistance R_E of the pylon is determined as a parallel circuit of the individual equivalent resistances:

$$R_E = \frac{1}{\frac{1}{R_{E1}} + \frac{1}{R_{E2}} + \frac{1}{R_{E3}} + \frac{1}{R_{E4}}}$$

1. Turn central rotary switch to position "**▷CR_E 3pole**" or "**▷CR_E 4pole**". The instrument is wired according Figure 7 and messages on the display.

A flashing of the sockets symbols **ⓔ** **Ⓢ** **Ⓜ** **Ⓜ** or **Ⓜ** **▷C**, points to an incorrect or incomplete connection of the measuring lead.

2. Apply current transformer to the pylon stub. Make sure that the transformation ratio set on the instrument corresponds to the current transformer used. Change settings if necessary (see "Changing of All Data Settings with Personalized CODE").
3. Press "START TEST" button.

Now a fully automated test sequence of all relevant parameters like auxiliary earth electrode, probe and earth electrode resistances, is implemented and finishes with the display of the result R_E .

4. Read out measured value R_E .
5. Call R_S and R_H with "DISPLAY MENU".

Notices for the setting of earth spikes:

Before setting the earth spikes for probe and auxiliary earth electrodes make sure that the probe is set outside the potential gradient of earth electrode and auxiliary earth electrode. Such a condition is normally reached by allowing a distance of >20 m between the earth electrode and the earth spikes as well as to the earth spikes to each other. An accuracy test of the results is made with another measurement after repositioning of auxiliary earth electrode or probe. If the result is the same, the distance is sufficient. If the measured value changes, probe or auxiliary earth electrode must be repositioned until the measured value R_E remains constant. Spike wires should not run too close.

1. Apply current transformer to next pylon stub.
2. Repeat measuring sequence.

Current feeding point of measuring current (alligator clip) and the polarity of the split core current transformer has to be left unchanged.

After values of R_{Ei} for each pylon foot are determined, the actual earth resistance R_E is calculated:

$$R_E = \frac{1}{\frac{1}{R_{E1}} + \frac{1}{R_{E2}} + \frac{1}{R_{E3}} + \frac{1}{R_{E4}}}$$

Note

If the displayed R_E value is negative despite correct orientation of the current transformer, a part of the measuring current is flowing upwards into the tower body. The earthing resistance, thus coming into effect, correctly calculates if the individual equivalent resistances (under observation of their polarity) are inserted into the equation above.

Time average measurement:

If there is a warning "MEASURED VALUE UNSTABLE" (see Table 5) after a test sequence, most likely it is caused by strong interference signals such as unsteady noise voltage.

For reliable values, the instrument offers averaging over a longer period:

1. Select a fixed frequency (see *Control Loop*).
2. Keep the "START TEST" button pressed until the warning "MEASURED VALUE UNSTABLE" disappears. Maximum averaging time is approximately 1 minute.

Measuring Earthing Impedance with 55 Hz (R^*)

For the calculation of short circuit currents in power supply plants, the complex earthing impedance is important. Direct measurement is possible under the following conditions:

Phase angle at 50 Hz: $30^\circ \dots 60^\circ$ inductive

Auxiliary earth electrode (ohmic): $>100 \cdot Z_E$

Measuring process:

The measurement of the earthing impedance (R^*) is only possible if it is activated by putting in a personalized user's code (see "Change of Setup Data with Personalized Code"). If this measuring function is activated, in every measurement of the four R_E positions, the earthing impedance R^* is displayed before all other measured values.

Clip-On Transformer Errors Correction

If the measurement of an earthing resistance by means of a clip-on transformer results in a significantly different value as if measured without the clip-on, the deviation may be due to the tolerances of the clip-on current transformer. This error can be corrected by fine tuning the clip-on transformation ratio (basic settings 1000:1). This correction applies to the transformer current range it was performed with. For other ranges a different correction may be necessary.

1. Connect a low Ohm resistor (approximately 1 Ohm - in the range you want to correct) as shown in Figure 8.

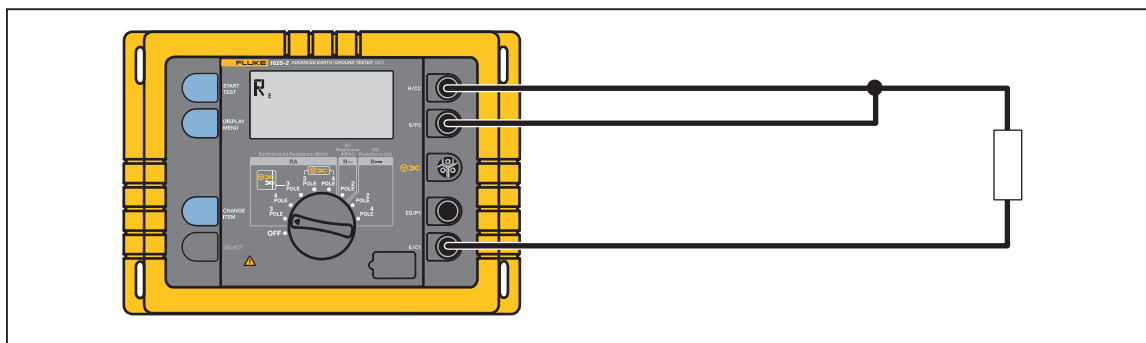

Figure 8. Correcting Clip-on Transformer Errors

edw017.eps

2. Turn central rotary switch to position "**➤** R_E 3pole".

3. Press "START TEST"-button and note result of R_E value.
4. Connect clip-on transformer. See Figure 9.

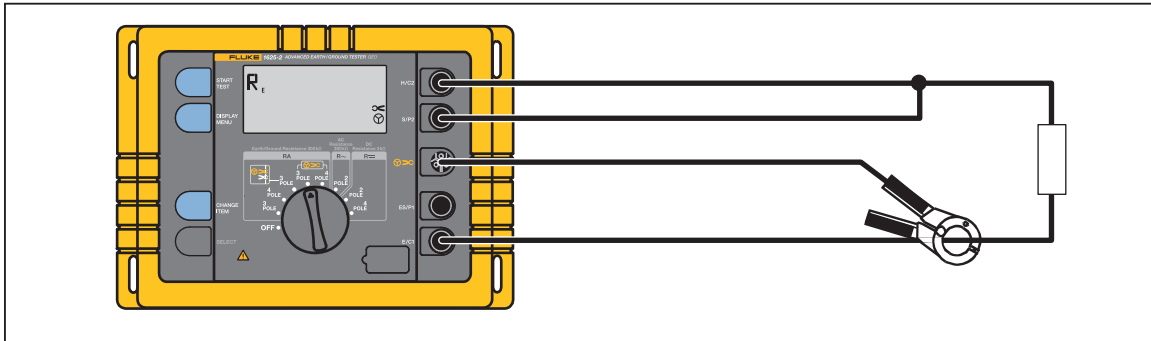

Figure 9. Clip-on Transformer Connection

edw018.eps

5. Turn central rotary switch to position "➤ RE 3pole".
6. Press "START TEST" again.

If the measured value R_E deviates from the R_E value determined without clip-on transformer by more than 5 %, adjust the clip-on transformation ratio (tr) correspondingly:

$$tr_{new} = tr_{old} \times \frac{R_E(\text{withclip} - \text{ontransformer})}{R_E(\text{withoutclip} - \text{onTransformer})}$$

Example:

Your clip-on transformer has a transformation ratio of $tr = 1000:1$. The measurement without clip-on transformer results in a value $R_E = 0.983 \Omega$. With a clip-on transformer a value of $R_E = 1.175 \Omega$ is measured.

The deviation thus reads $(1.175 - 0.983) \Omega = +0.192 \Omega$ and referring to $R_E = 0.983 \Omega$ an error evolves as following:

$$100\% \times \frac{0.192\Omega}{0.983\Omega} = +19.5\%$$

The new transformation ratio to be set calculates:

$$tr_{new} = 1000 \times \frac{1.175}{0.983} = 1195$$

Compensation of Earth Electrode Connecting Lead

If the line resistance to the earth electrode cannot be ignored, a compensation of the connecting lead resistance to the earth electrode is possible.

Measuring process:

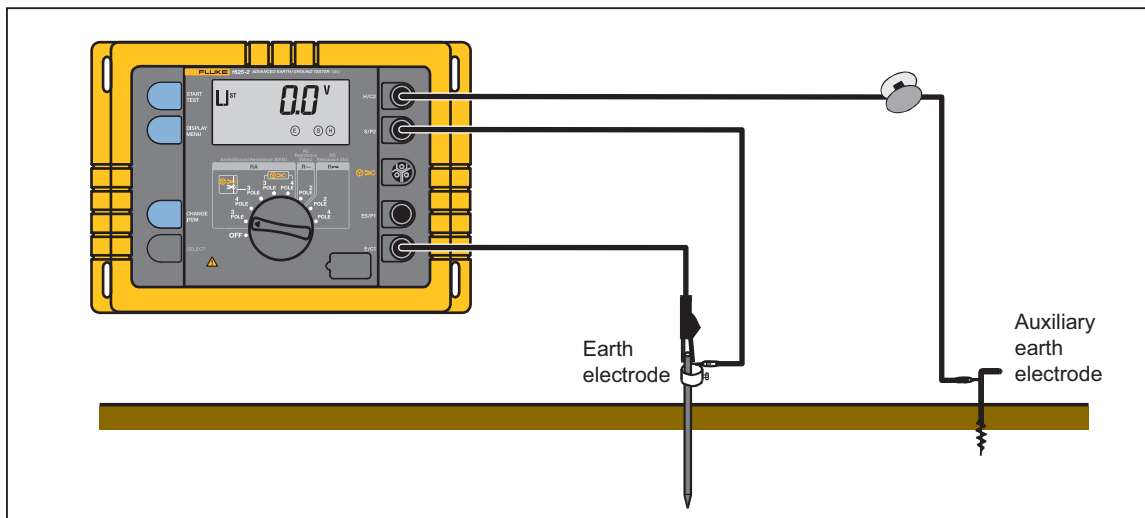

Figure 10. Compensation of Earth Electrode Connecting Lead

edw019.eps

To do a compensation:

1. Turn central rotary switch to position "R_E 3pole".
2. Wire instrument as shown in Figure 10.
3. Call display R_K with "DISPLAY MENU" button.
4. Implement compensation with "START TEST" button.

The compensation resistance is displayed only for as long as the "START TEST" button is kept pressed. After releasing the "START TEST" button the measured value is stored and the measuring instrument returns to the standard settings at the beginning of the measurement so that a succeeding measurement of the earthing resistance can be implemented by pressing "START TEST" again. Thereafter, R_K is subtracted from the actual measured value.

If the compensation value has to be reset to the basic setting (0.000 Ω), the compensation sequence has to be implemented with an open (disconnected) measuring lead or turn the switch to the next position and back.

Measurement of Soil Resistivity

The soil resistivity is the geological and physical quantity for calculation and design of earthing systems. The measuring procedure shown in Figure 11 uses the method developed by Wenner (F. Wenner, A method of measuring earth resistivity; Bull. National Bureau of Standards, Bulletin 12 (4), Paper 258, S 478-496; 1915/16).

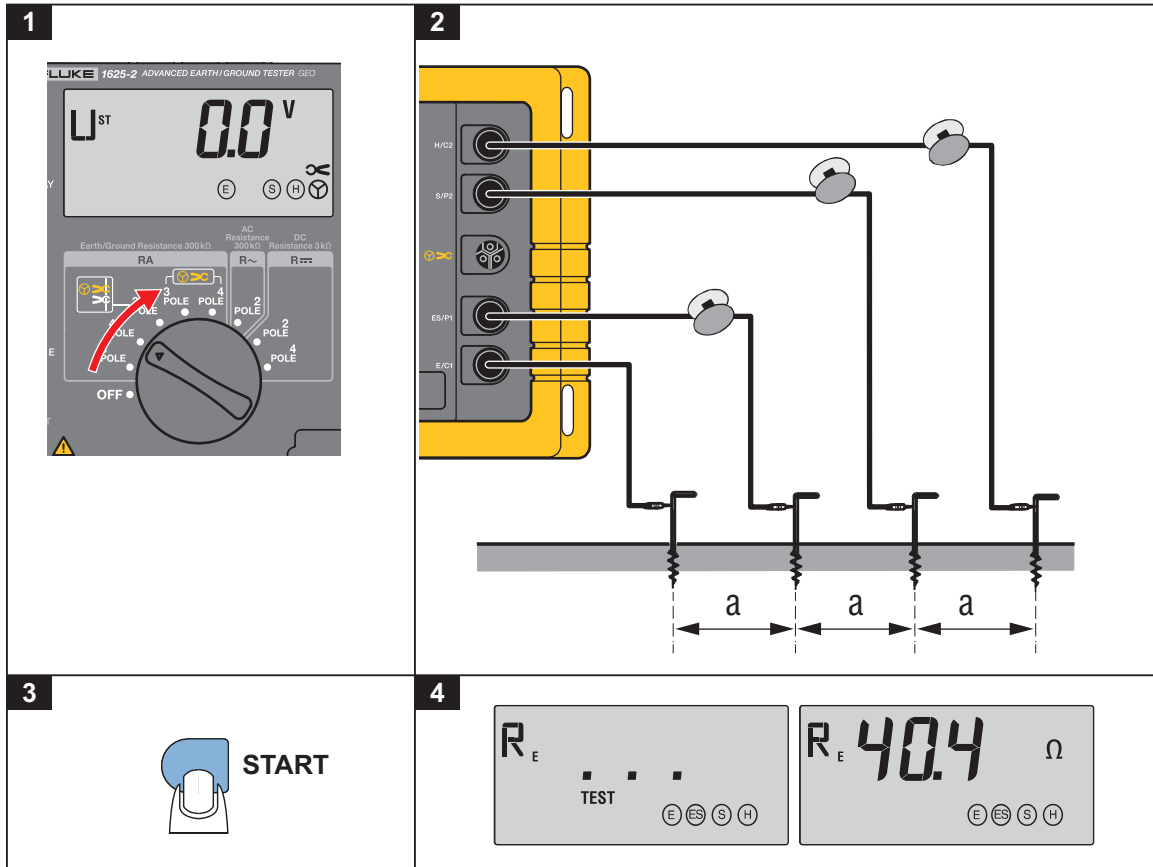

Figure 11. Measurement of Soil Resistivity

edw020.eps

1. Four earth spikes of the same length are positioned into the soil in an even line and with the same distance "a" to each other. The earth spikes should not be deeper than a maximum of 1/3 of "a".
2. Turn central rotary switch to position "R_E 4pole".
The instrument is to be wired according to picture and notices given on the display.
A flashing of the sockets symbols $\text{E} \text{ES} \text{S} \text{H}$ or $\text{Y} \text{DC}$, points to an incorrect or incomplete connection of the measuring lead.
3. Push "START TEST" button.

4. Read out measured value R_E .

From the indicated resistance value R_E , the soil resistivity calculates according to the equation:

$$\rho_E = 2\pi \cdot a \cdot R_E$$

ρ_E mean value of soil resistivity (Ωm)

R_E measured resistance (Ω)

a probe distance (m)

The measuring method according to Wenner determines the soil resistivity down to a depth of approximately the distance "a" between two earth spikes. By increasing "a", deeper strata can be measured and checked for homogeneity. By changing "a" several times, a profile can be measured from which a suitable earth electrode can be determined.

According to the depth to be measured, "a" is selected between 2 m and 30 m. This procedure results in curves depicted in the graph below.

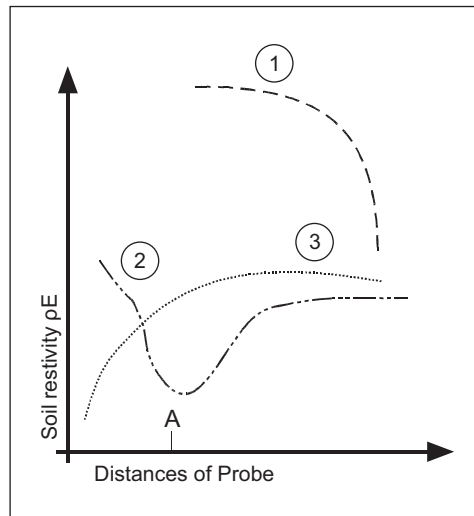

edw021.eps

Curve 1: As ρ_E decreases only deeper down, a deep earth electrode is advisable.

Curve 2: As ρ_E decreases only down to point A, an increase in the depth deeper than A does not improve the values.

Curve 3: With increasing depth ρE is not decreasing: a strip conductor electrode is advisable.

As measuring results are often distorted and corrupted, for example, by underground pieces of metal and underground aquifers, a second measurement, in which the spike axis is turned by an angle of 90° , is always advisable (see graph below).

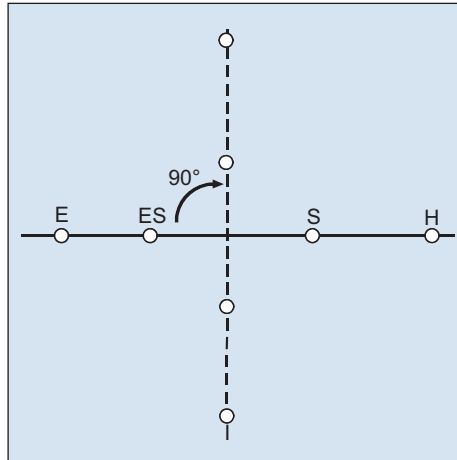

edw022.eps

Measurement of Resistances

Resistance Measurement ($R\sim$)

This measuring function determines the ohmic resistance between 0.02Ω and $300 \text{ k}\Omega$. The measurement is done with ac voltage. For measurements of very low resistances a compensation of the connecting leads is suggested (see *Compensation of Measuring Lead Resistance*).

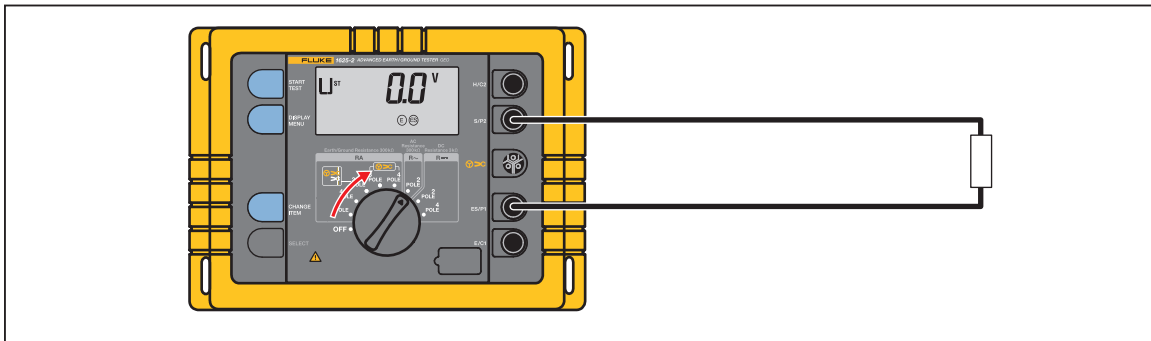

edw023.eps

Figure 12. Resistance Measurement ($R\sim$)

1. Turn central rotary switch to position "R~".
2. Connect instrument as shown in Figure 12.

3. In this mode, all settings and LIMIT values available can be called with "DISPLAY MENU" and the measuring frequency can be set.
4. Press "START TEST" button.
5. Read out measured value.

Resistance Measurement (R \rightarrow)

In this measuring mode all resistances from 0.02 Ω to 3 k Ω can be measured with dc voltage and automatic polarity reversal as per EN61557-5.

To achieve highest accuracy 4-pole measurements are possible. To balance the extension lead, a compensation has to be done.

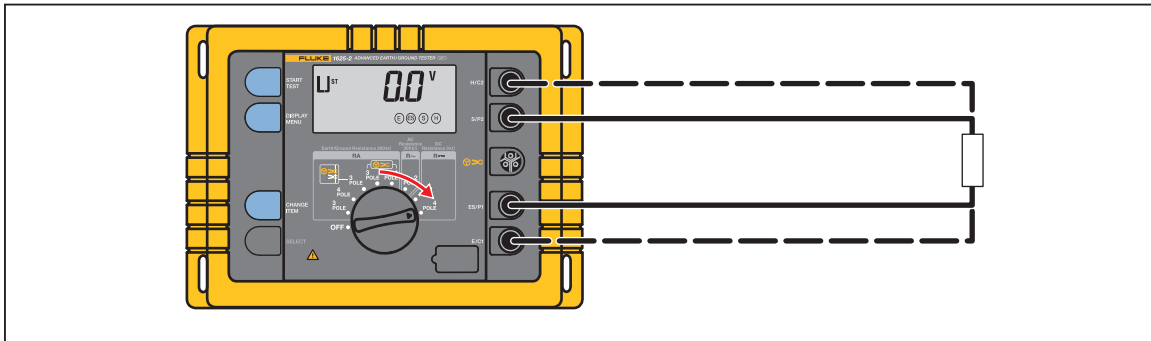

Figure 13. Resistance Measurement (R \rightarrow)

edw024.eps

1. Connect instrument as shown in Figure 13.
2. Turn central rotary switch to position "R \rightarrow ".
3. In this mode, all settings and LIMIT values available can be called with "DISPLAY MENU".

⚠⚠ Warning

Before starting a measurement, bring plant or test object to off or de-energized circuit condition. With an external voltage >3 V, the measurement will not start.

⚠⚠ Warning

Due to the high measuring current, inductive loads can cause lethal induced voltages during disconnection from the measuring circuit.

4. Start measurement with "START TEST" button. First, "R₁" with positive voltage is measured on jack "E". After releasing the "START TEST" button "R₂" is measured with negative voltage on jack "E". The respectively higher measured value is displayed first.
5. The second measured value can be called with "DISPLAY MENU". If the set limit value (R LIMIT) is exceeded the limit can also be displayed.

Compensation of Measuring Lead Resistance

1. Call display of R_K with button "DISPLAY MENU".
2. Short circuit measuring lead as shown in Figure 14.
3. Press "START TEST" button. Value R_K is stored after the release of the "START TEST" button, the display jumps back to voltage measurement. Thereafter, R_K is subtracted from the actual measured value. Turning the central rotary switch for a short moment deletes the line compensation again.

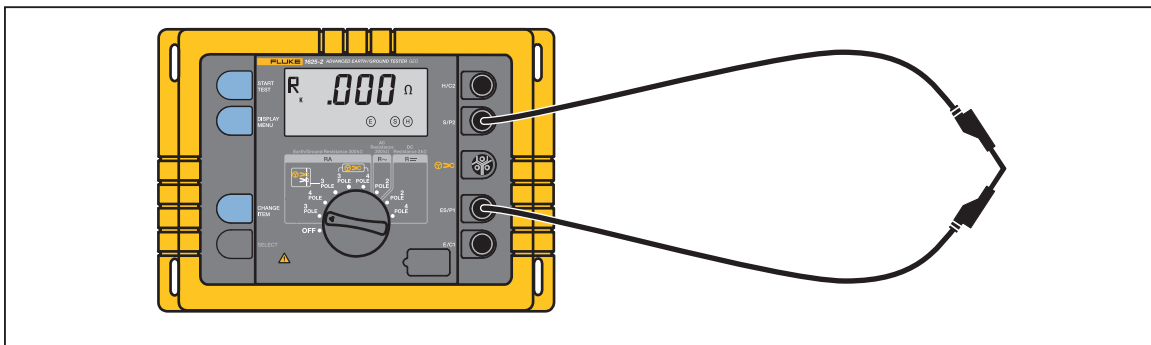

Figure 14. Compensation of Measuring Lead Resistance

edw026.eps

How to Change All Data Settings with Personalized CODE

With this function (FM, UM-Limit, Limit, beeper, ratio, R*) limit and set values can be programmed which keeps them in memory even if the instrument is switched ON/OFF. This feature enables the operator to create an instrument setup with customer defined settings according to the specific need.

Table 7 shows the settings that can be made only in the respective functions:

Table 7. Data Settings

Function	Parameter	Setting range	Standard presetting
RE 3pole and RE 4pole	FM	(AFC/94/105/111/128) Hz	AFC
	UM	48 V/20 V	48 V
	RK	0.000 Ω ... 29.99 Ω	0.000 Ω
	LIMIT	On / Off	Off
	RE LIMIT	0.000 Ω ... 999 kΩ	999 kΩ
	♪(warning sound)	On/Off	Off
	R*	On/Off	Off
RE 3pole ∞ and RE 4pole ∞	FM	(AFC/94/105/111/128) Hz	AFC
	UM	48 V/20 V	48 V
	RK	0.000 Ω ... 29.99 Ω	0.000 Ω
	I (ratio)	80 ... 1200	1000
	LIMIT	On/Off	Off
	RE LIMIT	0.000 Ω ... 999 kΩ	999 kΩ
	♪ (warning sound)	On/Off	Off
R*	On/Off	Off	
R~	FM	(AFC/94/105/111/128) Hz	AFC
	RK	0.000 Ω ... 29.99 Ω	0.000 Ω
	LIMIT	On/Off	Off
	R ~ LIMIT	0.000 Ω ... 999 kΩ	999 kΩ
	♪ (warning sound)	On/Off	Off
R≡ 2pole and 4pole			
	RK	0.000 Ω ... 29.99 Ω	0.000 Ω
	LIMIT	On/Off	Off
	R LIMIT	0.000 Ω ... 9,99 kΩ	9.99 kΩ
	♪(Warning sound)	On/Off	Off

To save a code:

1. Press all 4 keys simultaneously and move central selector from OFF to the desired measuring mode.

The display shows "C _ _ _".

2. Now enter the CODE number. Any three-digit number can be entered.

Note

Once a CODE has been entered, all subsequently programmed values can only be changed after entering the CODE number. Once a "CODE" has been entered, it cannot be erased or changed unless it is known. Be sure to record your personal "CODE" and store in a safe location.

3. Inputting the code is done by means of the "CHANGE ITEM" and "SELECT" keys.

4. Pressing the "DISPLAY MENU" key completes input.

The CODE is now stored, and the display shows "C ON".

5. If the display "C ON" is acknowledged by pressing "DISPLAY MENU", the first parameter of the selected measuring function is displayed and can be changed with the "CHANGE ITEM" and "SELECT" keys.

- a. The changed value is stored by pressing the "DISPLAY MENU" key.

- b. Pressing the "START TEST" key exits the setting program.

Note

If the limit values required by regulations are changed incorrect, erroneous test results may be displayed.

To delete a code:

1. Press all 4 keys simultaneously and move central selector from OFF to any measuring mode.

The display shows " C _ _ _".

2. Now enter the existing CODE number.

3. Inputting the code is done by means of the "CHANGE ITEM" and "SELECT" keys. Pressing the "DISPLAY MENU" key completes input.

4. Display shows "C ON". In the "C ON" state the CODE function can be disabled by pressing the "CHANGE ITEM" key. The display then shows "C OFF".
5. If this display is acknowledged by pressing the "DISPLAY MENU" key, the user code and all changes of the limit values are erased. The original default values are restored into memory.
6. Now a new CODE number may be programmed and used for setting new parameters.

Export Stored Data to PC

Test data is automatically stored for all tests as a .csv file. Table 8 (continued on page 40) is an example of the .csv file.

To export data from the Tester to a PC:

1. Connect the USB cable from the Tester to the PC.
2. Use Windows Explorer on the PC to find new **EGT drive** in the Devices list.
3. Locate the Data.csv file on the EGT drive.
4. Use the standard PC tools to copy the file to a new location.

Table 8. Sample .CSV File for Logged Data

Measurement	Timestamp	Measurement Mode	Measurement Voltage Um	Measurement Frequency Fm	Interference Voltage Ust
1	15th Oct 2013 20:13:55	3-pole R _E	48 V	128 Hz	0.0 V
2	15th Oct 2013 20:15:55	4-pole R _E	48 V	128 Hz	0.0 V
3	15th Oct 2013 20:17:15	3-pole Selective	48 V	128 Hz	0.2 V
4	15th Oct 2013 20:21:10	4-pole Selective	20 V	111 Hz	0.0 V
5	15th Oct 2013 20:23:25	2-pole AC Resistance	48 V	128 Hz	0.2 V
6	15th Oct 2013 20:24:48	2-pole DC Resistance	48 V	NA	0.2 V
7	10th Nov 2013 20:24:48	4-pole R _e	48 V	111 Hz	0.0 V
8	10th Nov 2013 20:28:48	4-pole Selective	48 V	128 Hz	0.0 V

Table 8. Sample .CSV File for Logged Data (cont.)

Measurement	Interference Frequency Fst	Interference Current	Earthing Impedance 55 Hz R*	Earth Ground Resistance Re	AC Resistance R~	DC Resistance R1
1	0.0 Hz	NA	NA	1.022 Ω	NA	NA
2	0.0 Hz	NA	1.02 Ω	1.022 Ω	NA	NA
3	100.0 Hz	0.0A	1.02 Ω	1.022 Ω	NA	NA
4	0.0 Hz	0.0A	NA	1006 Ω	NA	NA
5	100.0 Hz	NA	NA	NA	1.022 Ω	NA
6	100.0 Hz	NA	NA	NA	NA	1.023 Ω
7	0.0 Hz	NA	NA	NA	NA	NA
8	0.0 Hz	0.0A	NA	NA	NA	NA
Measurement	DC Resistance R2	Probe Resistance Rs	Auxiliary Resistance Rh	Compensation Resistance Rk	Transformer Ratio I	Error Status
1	NA	0.1 kΩ	0.1 kΩ	0.025 Ω	NA	NA
2	NA	0.1 kΩ	0.1 kΩ	NA	NA	NA
3	NA	0.1 kΩ	0.1 kΩ	0.075 Ω	1000	NA
4	NA	0.1 kΩ	0.5 kΩ	NA	1000	NA
5	NA	NA	NA	0.025 Ω	NA	NA
6	1.022 Ω	NA	NA	0.025 Ω	NA	NA
7	NA	NA	NA	NA	NA	E & H open
8	NA	NA	NA	NA	1000	Reverse clamp

Delete Stored Data

To delete stored data in the Tester:

1. Connect the USB cable from the Tester to the PC.
2. Use Windows Explorer on the PC to find new **EGT drive** in the Devices list.
3. Locate the Data.csv file on the EGT drive.
4. Use the standard PC tools to delete the file from the EGT drive or move the file to a new location.

This action removes all stored data from the Tester.

Maintenance

If used and treated properly, the instrument needs no maintenance. To clean the instrument, use only a moist cloth with some soap water or soft household detergent or spirit. Avoid aggressive cleaning agents and solvents, such as trilene or chlorothene.

Service work must only be undertaken by trained qualified staff.

In all repair work care must be taken that the design parameters of the instrument are not modified to the detriment of safety, that assembled parts correspond to the original spares and that they are reassembled properly (factory state).

⚠⚠ Warning

To prevent possible electrical shock, fire, or personal injury:

- **Use only specified replacement parts.**
- **Have an approved technician repair the Product.**
- **The battery door must be closed and locked before you operate the Product.**
- **Replace the batteries when the low battery indicator shows to prevent incorrect measurements.**
- **Batteries contain hazardous chemicals that can cause burns or explode. If exposure to chemicals occurs, clean with water and get medical aid.**
- **Remove the input signals before you clean the Product.**

⚠ Warning

For safe operation and maintenance of the Product:

- **Repair the Product before use if the battery leaks.**
- **Be sure that the battery polarity is correct to prevent battery leakage.**

Calibration

One-year calibration intervals are recommended.

Service

If you suspect that the tester has failed, review this manual to make sure you are operating it correctly. If the meter still fails to operate properly, pack securely (in its original container if available) and forward it, postage paid, to the nearest Fluke Service Center. Include a brief description of the problem. Fluke assumes NO responsibility for damage in transit.

To locate an authorized service center, go to www.fluke.com.

Specifications

Temperature Range	
Operating:	0 °C to +35 °C (+32 °F to +95 °F)
Storage:	-30 °C to +60 °C (-22 °F to +140 °F)
Temperature coefficient:	±0.1 % of rdg / °C (below 18 °C and above 28 °C)
Operating humidity:	<95% RH non-condensing
Operating altitude:	2000 m
Climatic Class:	C1 (IEC 654-1) -5 °C to +45 °C, 5% to 95% RH
Protection type	
Case:	IP56
Battery door:	IP40
Electromagnetic compatibility:	Complies with IEC61326-1: Portable
Safety:	Complies with IEC 61010-1: CAT None, Pollution Degree 2
Measurement time:	6 seconds, typical
Maximum overload:	250 V _{rms} (in association with misuse)
Batteries:	6 x 1.5v, AA LR6 Alkaline
Battery life span:	>3000 measurements, typical, RH + RE < 1 kOhm >6000 measurements, typical, RH + RE > 10 kOhm
Dimensions:	240 mm x 180 mm x 110 mm (9.5 in x 7.1 in x 4.4 in)
Weight with batteries:	1.52 kg (3.35 lb)
Memory:	Internal memory storage up to 1500 records accessible via USB port

Interference Voltage DC + AC (U_{ST}) Measurement

Measuring method: fullwave rectification

Measuring Range	Display Range	Resolution	Frequency Range	Accuracy
1...50 V	0.0...50 V	0.1 V	DC/AC 45...400 Hz sine	± (5% of rdg +5 digit)

Measuring sequence:	approximately 4 measurements/s
Internal resistance:	approximately 1.5 MΩ
Maximum overload:	U _{rms} = 250 V

Interference Frequency (F_{ST}) Measurement

Measuring method: Measurement of oscillation period of the interference voltage

Measuring Range	Display Range	Resolution	Range	Accuracy
16.0 ... 400 Hz	16.0...299.9...999 Hz	0.1 ... 1 Hz	1 V ... 50 V	±(1% rdg +2 digit)

Earthing Resistance (R_E)

Measuring method: Current and voltage measurement with probe as IEC61557-5

Open circuit voltage: 20 / 48 V, ac

Short circuit current: 250 mA ac

Measuring frequency: 94, 105, 111, 128 Hz selected manually or automatic. (AFC)
55 Hz in function R*

Noise rejection: >120 dB (16 2/3, 50, 60, 400 Hz)

Maximum overload: U_{rms} = 250 V

Table 9. Operational Error Calculation

Intrinsic Error or Influence Quantity	Reference Conditions or Specified Operating Range	Designation Code	Requirements or Test in Accordance with the Relevant Parts of IEC 1557	Type of Test
Intrinsic error	Reference conditions	A	Part 5, 6.1	R
Position	Reference position ±90°	E1	Part 1, 4.2	R
Supply voltage	At the limits stated by the manufacturer	E2	Part 1, 4.2, 4.3	R
Temperature	0 °C and 35 °C	E3	Part 1, 4.2	T
Series interference voltage		E4	Part 5, 4.2, 4.3	T
Resistance of the probes and auxiliary earth electrodes	0 to 100 x R _A but ≤50 kΩ	E5	Part 5, 4.3	T
System frequency	99 % to 101 % of the nominal frequency	E7	Part 5, 4.3	T
System voltage	85 % to 110 % of the nominal voltage	E8	Part 5, 4.3	T
Operating error	$B = \pm(A + 1,15\sqrt{E_1^2 E_2^2 E_3^2 E_4^2 E_5^2 E_6^2 E_7^2 E_8^2})$		Part 5, 4.3	R
A =	intrinsic error	$B[\%] = \pm \frac{B}{\text{fiducial value}} \times 100\%$		
En =	variations			
R =	routine test			
T =	type test			

Measuring Range	Display Range	Resolution	Accuracy	Operating Error
0.020 Ω...300 kΩ	0.001 Ω...2.999 Ω	0.001 Ω	± (2 % of rdg +2 digit)	± (5% of rdg +5 digit)
	3.00 Ω...29.99 Ω	0.01 Ω		
	30.0 Ω...299.9 Ω	0.1 Ω		
	0.300 kΩ...2.999 kΩ	1 Ω		
	3.00 kΩ...29.99 kΩ	10 Ω		
	30.0 kΩ...299.9 kΩ	100 Ω		

Measuring time: typical 8 seconds with a fixed frequency
30 seconds maximum with AFC and complete cycle of all measuring frequencies

Additional error because of probe and auxiliary earth electrode resistance: $\frac{R_H (R_S + 2000\Omega)}{R_E} \times 1.25 \times 10^{-6}\% + 5 \text{ digits}$

Measuring error of RH and RS: typical 10 % of $R_E + R_S + R_H$

Maximum probe resistance: ≤1 M Ω

Maximum auxiliary earth electrode resistance: ≤1 M Ω

If after a measurement of probe, auxiliary earth electrode, and earthing resistance, a measurement error of higher than 30 % is assumed because of the influencing conditions, the display shows a warning symbol Δ and a notice that R_S or R_H are too high.

R_H with Umeas = 48 V	R_H with Umeas = 20 V	Resolution
<300 Ω	<250 Ω	1 mΩ
<6 kΩ	<2.5 kΩ	10 mΩ
<60 kΩ	<25 kΩ	100 mΩ
<600 kΩ	<250 kΩ	1 Ω

Selective Measurement of the Earthing Resistance (R_E)

Measuring method:	Current and voltage measurement with probe as per EN61557-5 and current measurement in the individual branch with additional current transformer.
Open circuit voltage:	20 / 48 V ac
Short circuit current:	250 mA ac
Measuring frequency:	94, 105, 111, 128 Hz selected manually or automatically (AFC), 55 Hz (R^*)
Noise rejection:	120 dB (16 2/3, 50, 60, 400 Hz)
Maximum overload:	maximum Urms = 250 V

Measuring Range	Display Range	Resolution	Accuracy ^[1]	Operating Error ^[1]
0.020 Ω...30 kΩ	0.001...2.999 Ω	0.001 Ω	±(7 % of rdg +2 digit)	±(10% of rdg +5 digit)
	3.00...29.99 Ω	0.01 Ω		
	30.0...299.9 Ω	0.1 Ω		
	0.300...2.999 kΩ	1 Ω		
	3.00...29.99 kΩ	10 Ω		
[1] With recommended current clamps / transformers.				

Additional error because of probe and auxiliary earth typical electrode resistance:

$$\frac{R_H (R_S + 2000\Omega)}{R_{ETOTAL}} \times 1.25 \times 10^{-6}\% + 5 \text{ digits}$$

Measuring error of R_H and R_S :

typical of 10% of $R_{ETOTAL} + R_S + R_H$

Measuring time:

typical 8 seconds with a fixed frequency
30 seconds maximum with AFC and complete cycle of all measuring frequencies

Minimal current in single branch to be measured:

0.5 mA with transformer (1000:1)
0.1 mA with transformer (200:1)

Maximum interference current through transformer:

3 A with a transformer (1000:1)

Resistance Measurement (R₋)

Measuring method: current and voltage measurement
 Measuring voltage: 20 V ac, square pulse
 Short circuit current: >250 mA ac
 Measuring frequency: 94, 105, 111, 128 Hz selected manually or automatically (AFC)

Measuring Range	Display Range	Resolution	Accuracy	Operating Error
0.020 Ω...300 kΩ	0.001 Ω ... 2.999 Ω	0.001 Ω	±(2 % of rdg +2 digit)	±(5% of rdg +5 digit)
	3.0 Ω ... 29.99 Ω	0.01 Ω		
	30 Ω ... 299.9 Ω	0.1 Ω		
	300 Ω ... 2999 Ω	1 Ω		
	3.0 kΩ ... 29.99 kΩ	10 Ω		
	30.0 kΩ ... 299.9 kΩ	100 Ω		

Measuring time: typical 6 seconds
 Maximum interference voltage: 24 V, with higher voltages measurement will not be started
 Maximum overload: U_{rms} maximum = 250 V

Resistance Measurement (R_≡)

Open circuit voltage: 20 V dc
 Short circuit current: 200 mA dc
 Formation of measured value: with 4-pole measurement wires on (H)(S)(ES) can be extended without additional error
 Resistances >1 Ω in wire (E) can cause additional error of 5 mΩ/Ω

Measuring Range	Display Range	Resolution	Accuracy	Operating Error
0.020 Ω...3 kΩ	0.001 Ω ... 2.999 Ω	0.001 Ω	±(2 % of rdg +2 digit)	±(5% of rdg +5 digit)
	3.0 Ω ... 29.99 Ω	0.01 Ω		
	30.0 Ω ... 299.9 Ω	0.1 Ω		
	300 Ω ... 2999 Ω	1 Ω		

Measuring sequence:	approximately 2 measurements/s
Measuring time:	typical 4 seconds includes reversal of polarity (2-pole or 4-pole)
Maximum interference voltage:	≤3 V ac or dc, with higher voltages measurement will not be started
Maximum inductivity:	2 Henry
Maximum overload:	$U_{rms} = 250 \text{ V}$

Compensation of Lead Resistance (R_K)

Compensation of lead resistance (R_K) can be switched on in functions R_E 3pole, R_E 3pole **DC**, R_{\sim} , and $R_{\text{---}}$ 2pole

Formation of measured value: $R_{display} = R_{measured} - R_{compensated}^*$

* Value of setpoint entry $R_K = 0.000 \Omega$, variable from 0.000...29.99 Ω by means of measuring adjustment.

Stakeless Ground Loop Measurement (⊕⊖)

Resolution	Measurement range	Accuracy	Operating Error
0.001 to 0.1 Ω	0.020 Ω to 199.9 Ω	$\pm(7\% \text{ rdg} + 3 \text{ d})$	$\pm(10\% \text{ rdg} + 5 \text{ d})$

Measuring principle: Stakeless measurement of resistance in closed loops using two current clamps

Measurement voltage:	$U_m = 48 \text{ V ac (primary)}$
Measurement frequency:	128 Hz
Noise current (I_{ext}):	max $I_{ext} = 10 \text{ A (ac)}$ ($R_a < 20 \Omega$) max $I_{ext} = 2 \text{ A (ac)}$ ($R_a > 20 \Omega$)

The information about stakeless ground loop measurements is only valid when used in conjunction with the recommended current clamps at the minimum distance specified.

