



ENGLISH

Datasheet

RS Pro Die Cast Zinc Removable Offset Lift-off Hinge

RS Stock No: 110-4578

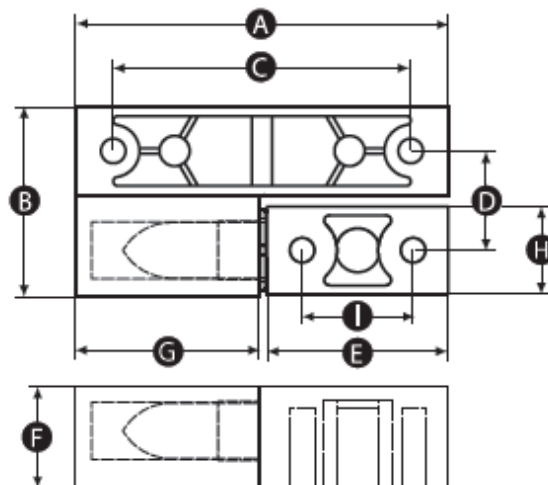

Material

Die cast zinc

Finish

Matt

Colour

Black

Part No.	A	B	C	D	E	F	G	H	I	Thread size	Chirality
1104577	64	32.5	51	17	31	17.5	31.5	15	19	M5	Left-Handed
1104578	64	32.5	51	17	31	17.5	31.5	15	19	M5	Right-Handed

Part No.	Radial load (Nm)	Axial load (Nm)	Recommended tightening torque (Nm)	Approx. shear force per screw (kN)
1104577	400	1130	1.5	0.28
1104578	400	1130	1.5	0.28

Mounting options

A Install hinges with matching vertical orientation to enable quick, easy and safe removal of doors without the use of tools.

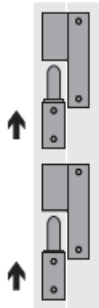

B Install hinges with opposing vertical orientation to enable doors to be permanently mounted.



Chirality

Left-Handed

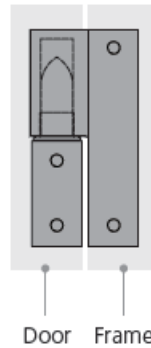

Right-Handed

