

Datasheet

G57 Series 50 Way Straight PCB Socket Through Hole

RS Stock number 239-1140

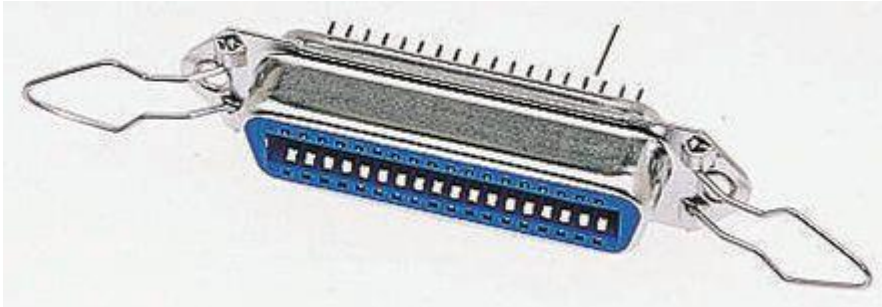

Dimensions: (mm)

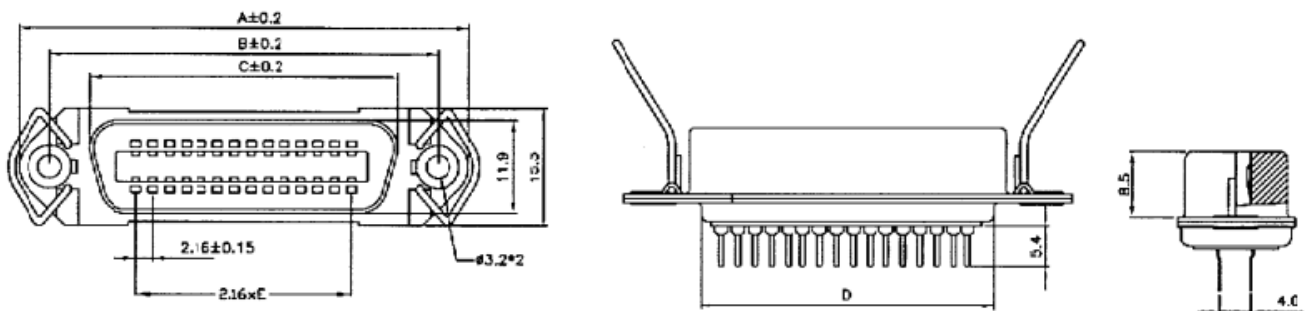

Specifications

- Shell: Steel, Nickel over copper plated
- Contacts: Brass alloy gold plated on contact tin plated
- Current rating: 5 AMP
- Contact Resistance: < 25m ohm
- Insulation Resistance: > 100 ohm at 500V
- Operating temperature range: -55°C to +105°C