

19" HEAVY DUTY RACK CASE			
Item	Description	Material	Qty.
1	BASE PANEL	Mild Steel 1.20 mm.	1
2	SIDE PANEL	Mild Steel 2.00 mm.	2
3	REAR PANEL	Mild Steel 1.20 mm.	1
4	FRONT PANEL	AL 3.00 mm.	1
5	TOP COVER (Option)	Mild Steel 1.20 mm.	1
6	HANDLE	AL Extruded	2
7	SCREW M5 X 15 mm. PAN HEAD BLK.	Steel	4
8	SCREW M4 X 8 mm. PAN HEAD BLK. (With washer)	Steel	12

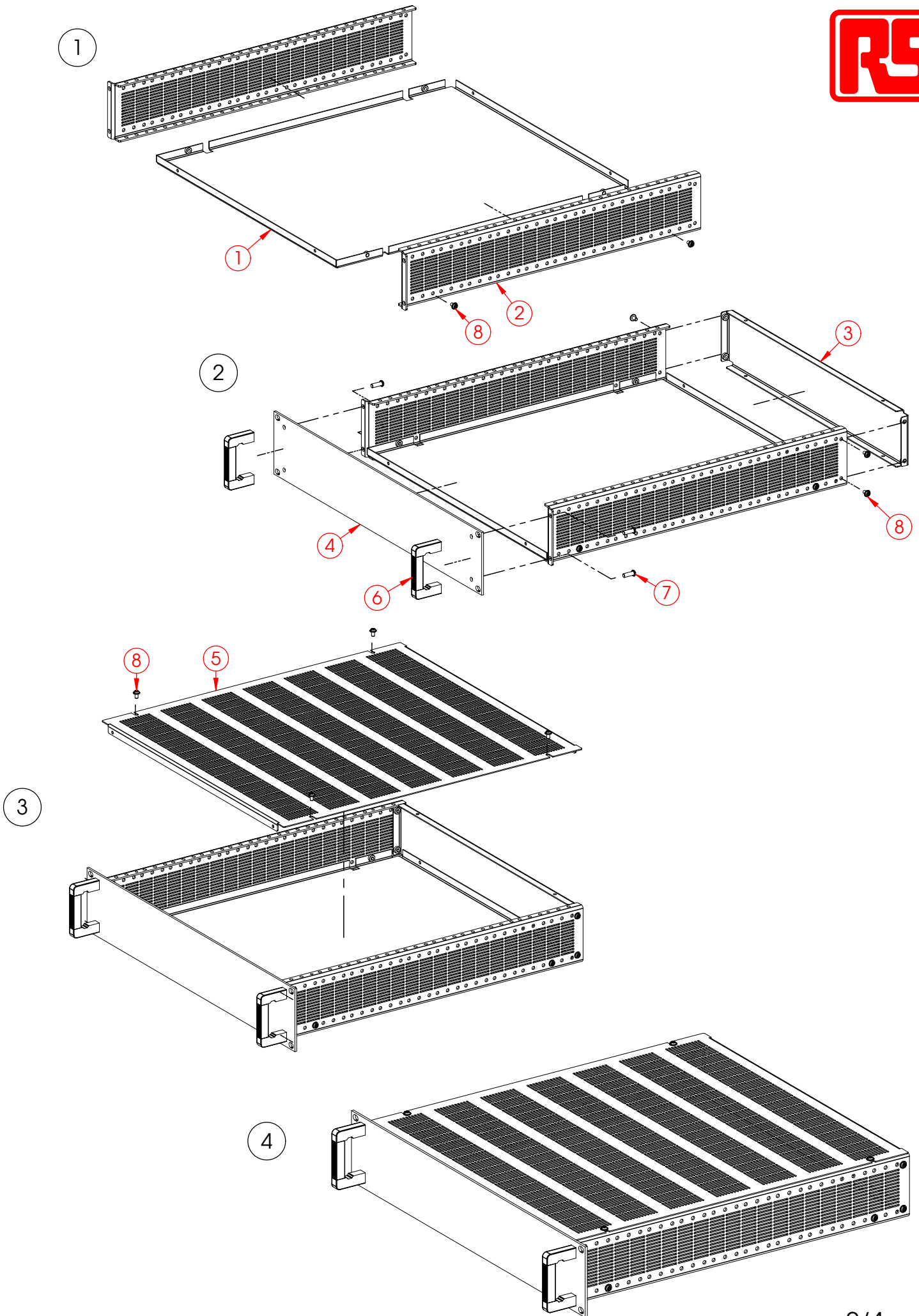

19" RACK INSTALLATION GUIDE

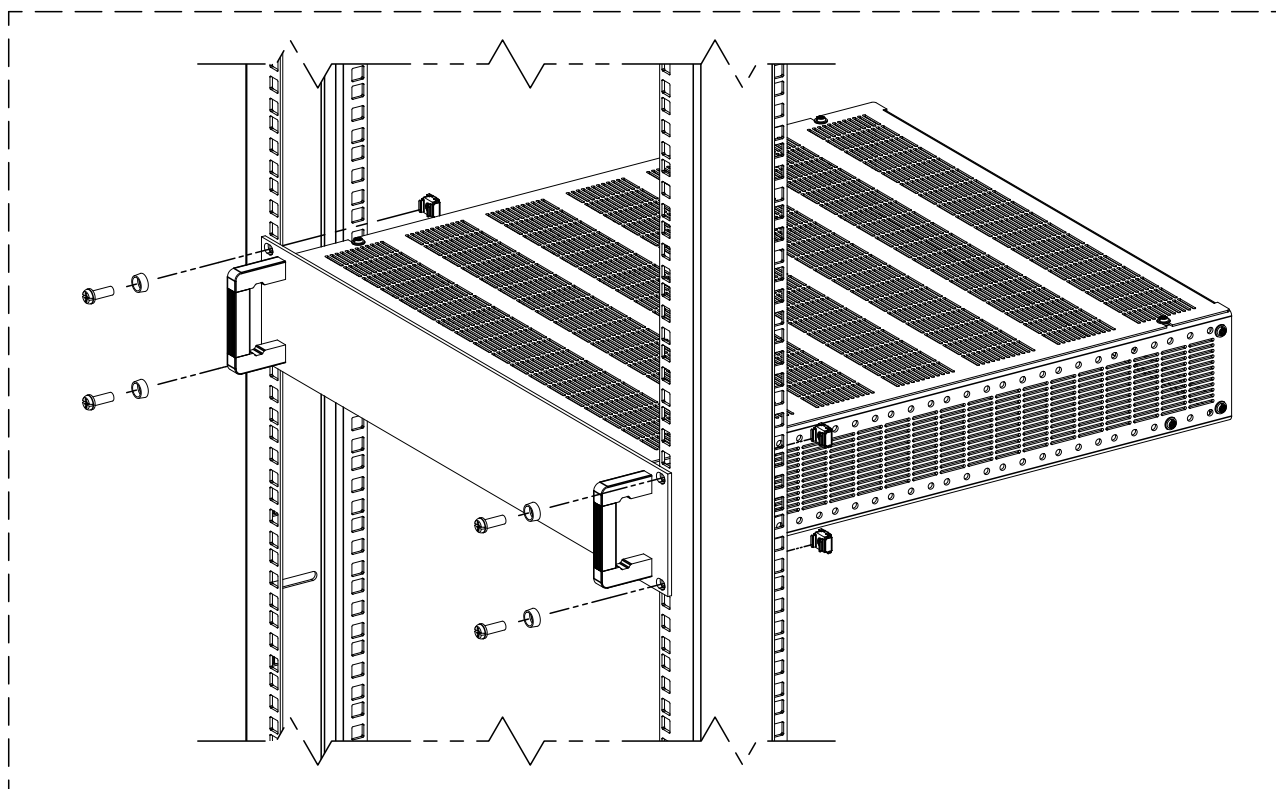

INSTALLATION HARDWARE NOT INCLUDED

Article #	Description
6657630	Heavy duty rack case, 1U 46 6x 423 x 34 mm.
6657633	Heavy duty rack case, 2U 466 x 423 x 79 mm.
6657637	Heavy duty rack case, 3U 466 x 423 x 123 mm.
6657646	Heavy duty rack case, 4U 466 x 423 x 168 mm.
6657649	Heavy duty rack case, 5U 466 x 423 x 212 mm.
6657643	Heavy duty rack case, 6U 466 x 423 x 256 mm.

Article #	Description (Optional Lid)
6657652	Heavy Duty rack case vented top cover
6657655	Heavy Duty rack case unvented top cover

AVAILABLE DIMENSIONS : 19" HEAVY DUTY RACK CASE



- HEIGHT : 1U to 6U (B)
- WIDTH : 483 (A)
- DEPTH : 466 (D)

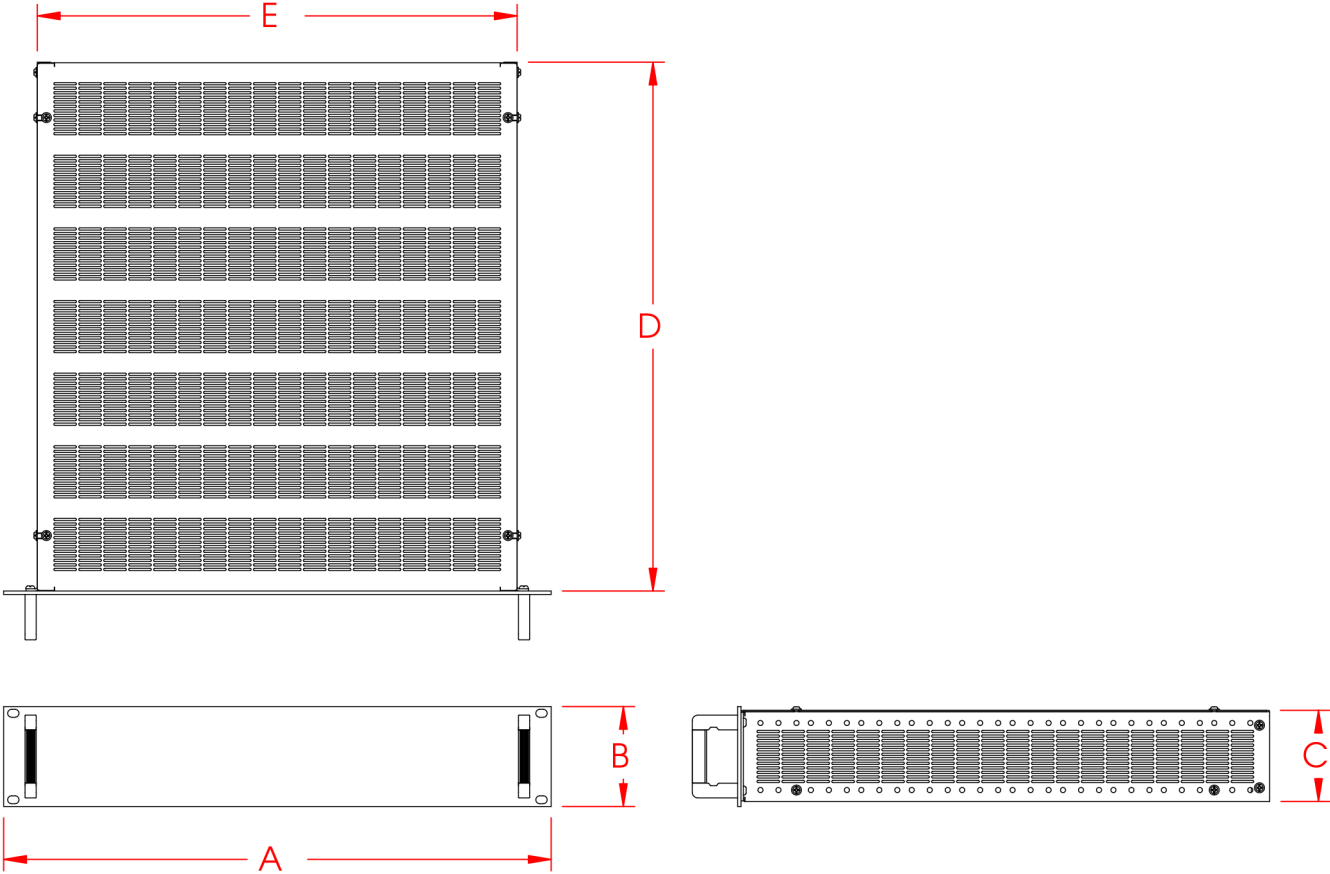

ARTICLE#	MODEL	FRONT PANEL (A+B)	HANDLE HEIGHT	CABINET (E X D X C)
6657630	1U	483 X 44	25	423 X 466 X 34
6657633	2U	483 X 88	60	423 X 466 X 79
6657637	3U	483 X 133	90	423 X 466 X 123
6657646	4U	483 X 177	130	423 X 466 X 168
6657649	5U	483 X 222	160	423 X 466 X 212
6657643	6U	483 X 266	160	423 X 466 X 256