



Datasheet

ENGLISH

RS PRO, 12 V dc, 2400 gcm, Brushed DC Geared Motor, Output Speed 8 rpm

Stock No: 420-710



Specifications:

Output Speed	8 rpm
Supply Voltage	12 V dc
Maximum Output Torque	2400 g.cm
DC Motor Type	Brushed
Shaft Diameter	3mm
Power Rating	0.47 W
Gearhead Type	Planetary
Length	56.5mm
Width	16 (Dia.) mm
Current Rating	115 mA
Weight	50g

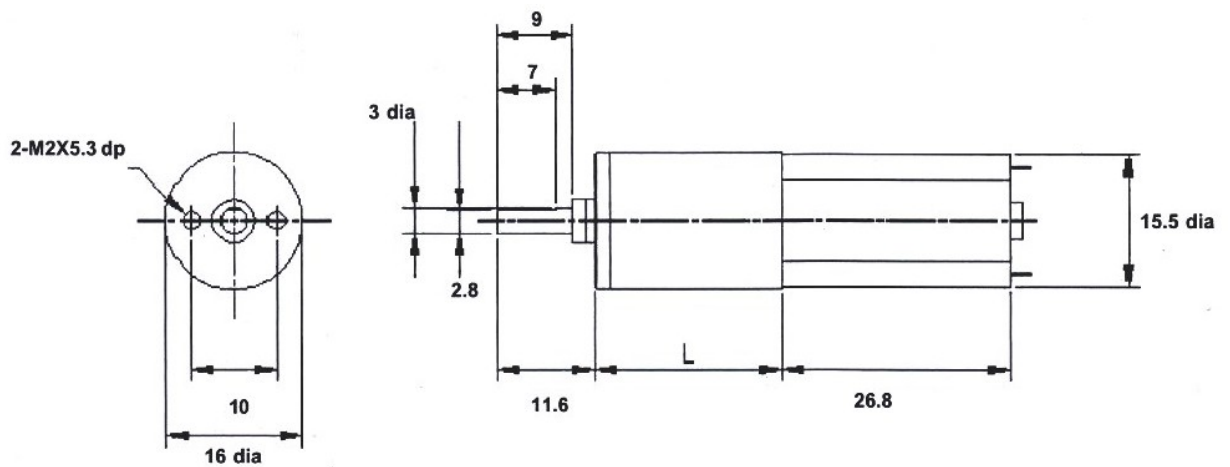

Operating relative humidity 20% ~ 85%
 Operating temperature range -10°C ~ +60°C

Ratio	L
1014:1	29.7mm

Gearbox Housing material	Metal
Backlash at no-load	< 3°
Bearing at output	Sleeve bearings
Radial load (10mm from flange)	< 0.5 kgf
Shaft axial load	< 0.5 kgf
Shaft press fit force max	< 1.5 kgf
Radial play of shaft	< 0.08mm
Thrust play of shaft	< 0.2mm

Reduction Ratio	Rated tolerance Torque	Max momentary Tolerance Torque	Efficiency
1/1014	2.4 kgf-cm Max.	7.2 kgf-cm	40%

Reduction Table RPM SUPPLY VOLTAGE	3v	6v	9v	12v
420-710	2	4	6	8

Note: Motor speeds may vary by (+) or (-) 12.5%
 Note: It is not recommended to run the motor/gearbox combination at 1.5v