

MAXM17761 5V Output Evaluation Kit

Evaluates: MAXM17761 5V Output-Voltage Application

General Description

The MAXM17761 5V-output evaluation kit (EV kit) provides a proven design to evaluate the MAXM17761 high-voltage, high-efficiency, synchronous step-down DC-DC converter. The EV kit is preset for 5V output at load currents up to 1A and features a 537kHz switching frequency for optimum efficiency and component size. The EV kit features an adjustable input undervoltage lockout, adjustable soft-start, open-drain $\overline{\text{RESET}}$ signal, and external frequency synchronization. The MAXM17761 module data sheet provides a complete description of the part that should be read in conjunction with this data sheet prior to operating the EV kit. For full features, benefits and parameters of the MAXM17761 module, refer to the MAXM17761 data sheet.

Benefits and Features

- Highly Integrated Solution with Integrated Shielded Inductor
- Wide 10V to 76V Input Range
- Up to 1A Output Current
- High 91% Efficiency ($V_{\text{IN}} = 12\text{V}$, $V_{\text{OUT}} = 5\text{V}$ at 0.2A)
- 537kHz Switching Frequency
- Enable/UVLO Input, Resistor-Programmable UVLO Threshold
- Adjustable Soft-Start Time
- Open-Drain $\overline{\text{RESET}}$ Output
- Provision for External Frequency Synchronization
- Overcurrent and Overtemperature Protection
- Low-Profile, Surface-Mount Components
- Proven PCB Lat
- Fully Assembled and Tested
- CISPR-22 Class B Compliant

Quick Start

Recommended Equipment

- One 10V–76V DC, 1A power supply
- 5W resistive load with 1A sink capacity
- Four digital multimeters (DMM)
- One MAXM17761EVKIT# EV kit

Equipment Setup and Test Procedure

The EV kit is fully assembled and tested. Follow the steps below to verify the board operation.

Caution: Do not turn on power supply until all connections are completed.

- 1) Set the power supply at a voltage between 10V and 76V. Disable the power supply.
- 2) Connect the positive terminal of the power supply to the VIN_EMI PCB pad and the negative terminal to the nearest PGND PCB pad. Connect the positive terminal of the 1A load to the VOUT PCB pad and the negative terminal to the nearest PGND PCB pad.
- 3) Connect the DVM across the VOUT PCB pad and the nearest PGND PCB pad.
- 4) Verify that shunts are installed across pins 2-3 on jumper J1 (see [Table 1](#) for details) and across pin 1-2 of J2.
- 5) Turn on the DC power supply.
- 6) Enable the load.
- 7) Verify that the DVM displays 5V across the output terminals.

[Ordering Information](#) appears at end of data sheet.

MAXM17761 5V Output Evaluation Kit

Evaluates: MAXM17761 5V Output-Voltage Application

Detailed Description

The MAXM17761 5V output EV kit is designed to demonstrate the salient features of the MAXM17761 power module. The MAXM17761 EV kit includes an EN/UVLO PCB pad and jumper J1 to enable the output at a desired input voltage. The RT/SYNC PCB pad allows an external clock interface to synchronize with the device. An additional $\overline{\text{RESET}}$ PCB pad is available for monitoring if the converter output is in regulation.

On the bottom layer of the EV kit, additional footprints for optional components are included to ease board modification for different input/output configurations. The evaluation board has place holders available on the bottom layer for installation of EMI filter components.

Setting the Switching Frequency

Selection of switching frequency must consider input Voltage range, desired output voltage, $t_{\text{ON-MIN}}$ of the MAXM17761, and ambient temperature. To optimize efficiency and component size, a switching frequency of 537kHz is chosen. Resistor R3 connected between RT/SYNC and PGND pins, programs the desired switching frequency. Using Table 1 in the MAXM17761 data sheet, R3 is chosen to be 69.8k Ω . Table 2 in the MAXM17761 data sheet lists the various switching frequency recommendations for optimized designs.

Input Capacitor Selection

The input capacitor serves to reduce the current peaks drawn from the input power supply and also reduce switching frequency voltage ripple at the input. Table 2 in the MAXM17761 data sheet summarizes the choice of Input capacitor for various requirements. Using this table, the input capacitor (C2) for this EV kit is chosen to be 2.2 $\mu\text{F}/100\text{V}$.

Output Capacitor Selection

Ceramic output capacitors are preferred due to their stability over temperature in industrial applications. Table 2 in MAXM17761 data sheet summarizes the choice of output capacitor for various requirements. Using this table, the output capacitor (C12) for this EV kit is chosen to be 47 $\mu\text{F}/10\text{V}$.

Adjusting Output Voltage

MAXM17761 supports an adjustable output voltage range, from 0.8V to 5V, using a feedback resistive divider from VOUT to PGND. In this EV kit, by placing a shunt across 1-2 of jumper J2, the resistive divider is formed by R7 and internal 22.1k Ω . By placing a shunt across 2-3 of

jumper J2, the resistive divider is formed by R7 and R9. See Table 2 for J2 settings.

To get different output voltages, refer to Table 2 in MAXM17761 datasheet. R7 and R9 of the EV kit correspond to R_U and R_B of *Setting the Output Voltage* section in the MAXM17761 data sheet.

Soft-Start Capacitor

MAXM17761 offers an adjustable soft-start function to limit inrush current during startup. The soft-start time is adjusted by changing the value of C10, the external capacitor from SS pin to PGND. The capacitance required for a given soft-start time (t_{SS}) is given by the following equation:

$$C_{\text{SS}} \geq 6.25 \times 10^{-6} \times t_{\text{SS}}$$

For example, to program a 5ms soft-start time, a 33nF capacitor should be connected from SS pin to PGND.

A parallel combination of the internal SS_C capacitor and the optional external capacitor (C10) can also be used to program soft-start time.

Enable/Undervoltage-Lockout (EN/UVLO)

MAXM17761 offers an adjustable input undervoltage lockout feature. In this EV kit, place a shunt across pins 2-3 of Jumper J1 to enable the power conversion when V_{IN} exceeds 9.5V. To disable the output, install a shunt across pins 1-2 of J1. Leave jumper J1 pins open for always-on operation. See Table 1 for J1 settings. Calculate the value of R1 and R2 based on the following equations.

$$R1 \leq (110000 \times V_{\text{INU}})$$

Where V_{INU} is the input voltage at which the MAXM17761 is required to turn on and R1 is in Ω .

Calculate the value of R2 in Ω as follows

$$R2 = \frac{1.215 \times R1}{(V_{\text{INU}} - 1.215 + (2.5\mu\text{A} \times R1))}$$

For the MAXM17761 to turn on at 9.5V input, resistor (R1) is chosen as 806k Ω and resistor (R2) is calculated as 95.3k Ω .

External Clock Synchronization (RT/SYNC)

The internal oscillator of MAXM17761 can be synchronized to an external clock signal through the RT/SYNC pin. External synchronization clock frequency must be between $1.15 \times f_{\text{SW}}$ and $1.4 \times f_{\text{SW}}$, where f_{SW} is the frequency of operation as set by resistor R3. The minimum external clock low pulse width should be greater than 40ns, and the amplitude of external clock pulse should be greater 1.22V.

MAXM17761 5V Output Evaluation Kit

Evaluates: MAXM17761 5V Output-Voltage Application

EXTVCC Linear Regulator

Powering VCC from EXTVCC increases the efficiency at higher input voltages. If the applied EXTVCC voltage is greater than 4.74V (typ), VCC is powered from EXTVCC. If EXTVCC is lower than 4.74V (typ), VCC is powered from VIN. Refer to the MAXM17761 module data sheet for further information. Resistor R6 (0Ω) connects VOUT to EXTVCC in this EV kit.

Electromagnetic Interference (EMI)

Compliance to conducted emissions (CE) standards requires an EMI filter at the input of a switching power converter. The EMI filter attenuates high-frequency currents drawn by the switching power converter and limits the noise injected back into the input power source.

The MAXM17761 EV kit PCB has designated footprints on the bottom side for placement of EMI filter components. Use of EMI filter components, as shown in the schematic, results in lower conducted emissions, below CISPR22 Class B limits. Cut open the trace at L₁, before installing EMI filter components. The MAXM17761 EV kit PCB layout is also designed to limit radiated emissions from switching nodes of the power converter, resulting in radiated emissions below CISPR22 Class B limits.

Hot-Plug-In and Long Input Cables

The MAXM17761 EV kit PCB provides an optional electrolytic capacitor (C₁, 22μF/100V). This capacitor limits the peak voltage at the input of the MAXM17761 power module, when the DC input source is “Hot-Plugged” to the EV kit input terminals with long input cables. The equivalent series resistance (ESR) of the electrolytic capacitor dampens the oscillations caused by interaction of the inductance of the long input cables, and the ceramic capacitors at the power module input.

Table 1. UVLO Enable/Disable Configuration (J1)

POSITION	EN/UVLO PIN	MAXM17761 OUTPUT
Not Installed	Floating	Enabled
2–3*	Connected to the center node of resistor-divider R1 and R2	Programmed to startup at desired input voltage level set by R1 and R2
1–2	Connected to PGND	Disabled

*Default position.

Table 2. Adjusting the Output Voltage (J2)

POSITION	FB PIN
1–2*	Connected to the center node of resistor-divider R7 and internal feedback resistor.
2–3	Connected to the center node of resistor-divider R7 and R9
Not Installed	Results in V _{OUT} = 0.8V

*Default position.

MAXM17761 5V Output Evaluation Kit

Evaluates: MAXM17761 5V Output-Voltage Application

EV Kit Performance Report

($V_{IN} = 24V$, $V_{OUT} = 5V$, $I_{OUT} = 1A$, $T_A = 25^\circ C$. All voltages are referenced to PGND, unless otherwise noted.)

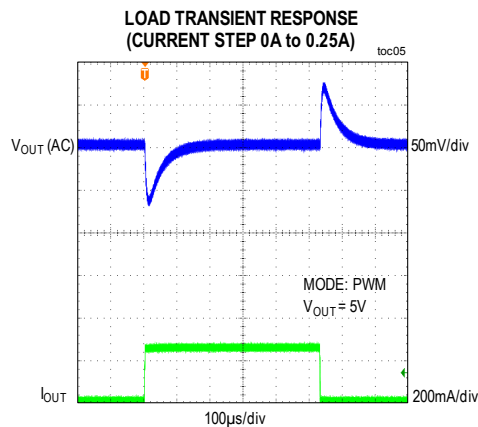
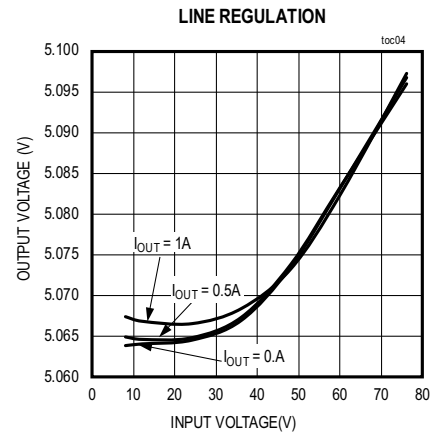
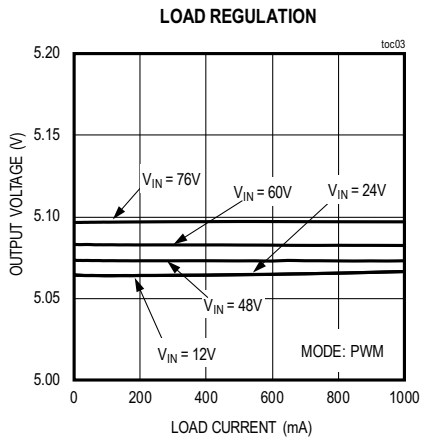
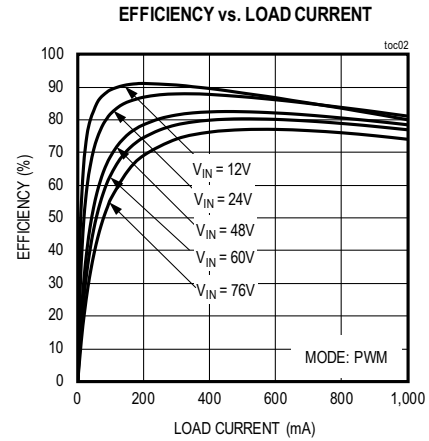
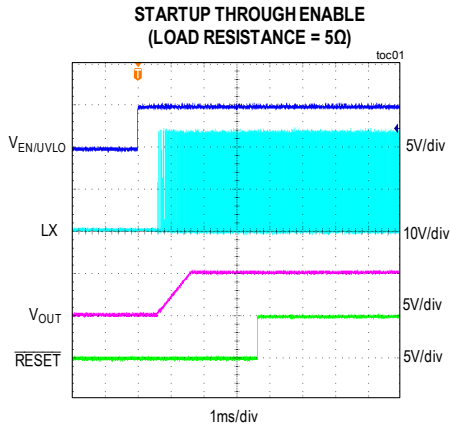

MAXM17761 5V Output Evaluation Kit

Evaluates: MAXM17761 5V Output-Voltage Application

EV Kit Performance Report (continued)

($V_{IN} = 24V$, $V_{OUT} = 5V$, $I_{OUT} = 1A$, $T_A = 25^\circ C$. All voltages are referenced to PGND, unless otherwise noted.)

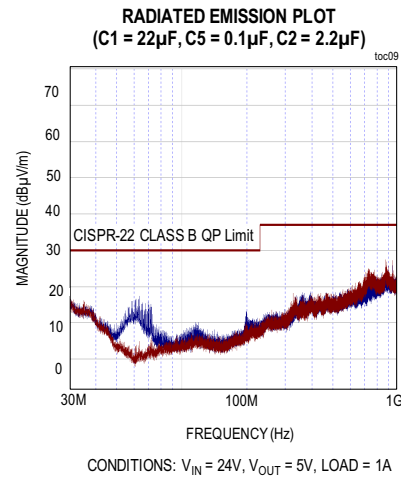
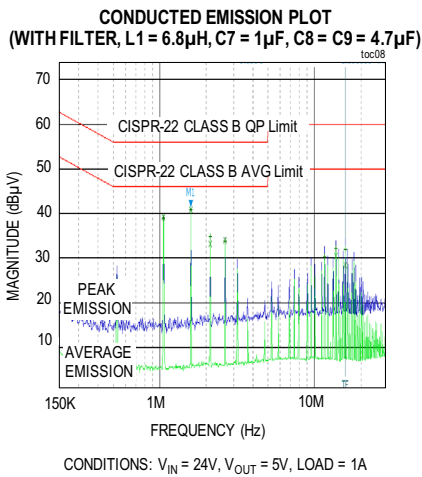
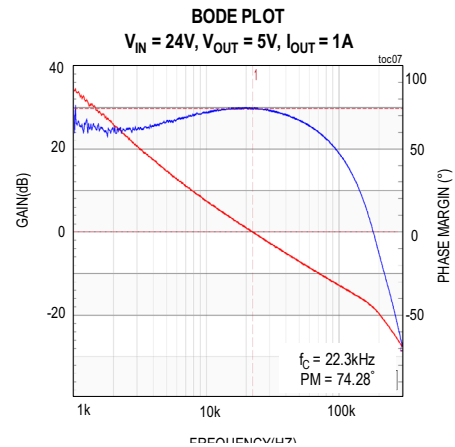
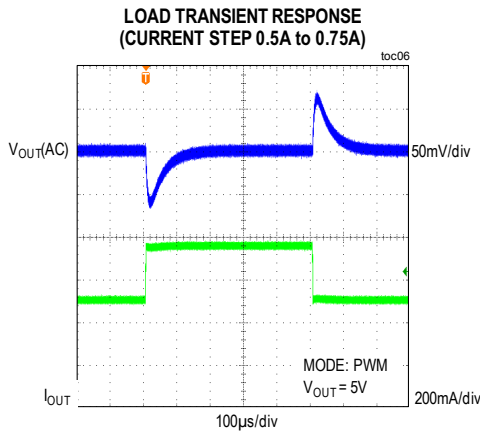

Component Suppliers

SUPPLIER	WEBSITE
Murata Americas	www.murata.com
NEC TOKIN America, Inc.	www.nec-tokinamerica.com
Panasonic Corp.	www.panasonic.com
SANYO Electric Co., Ltd.	www.sanyodevice.com
TDK Corp.	www.component.tdk.com
TOKO America, Inc.	www.tokoam.com

Note: Indicate that you are using the MAXM17761 when contacting these component suppliers.

Ordering Information

PART	TYPE
MAXM17761EVKIT#	EV Kit

#Denotes RoHS compliant.

MAXM17761 EV Kit Bill of Materials

S NO	DESIGNATION	QTY	DESCRIPTION	MANUFACTURER PARTNUMBER-1	MANUFACTURER PARTNUMBER-2
1	C1	1	22µF±20%, 100V, Aluminum Capacitor	PANASONIC EEE-FK2A220P	
2	C2	1	2.2µF±10%, 100V, X7R ceramic capacitor (1206)	MURATA GRM31CR72A225KA73	
3	C3	1	47PF±5%, 25V, X7R ceramic capacitor (0402)	MURATA GRM1555C1E470JA01	
4	C4	1	OPEN(0603)	OPEN	
5	C5	1	0.1µF±10%, 100V, X7R ceramic capacitor (0603)	MURATA GRM188R72A104KA35	Yageo CC0603KRX7ROBB104
6	C6	1	OPEN(1206)	OPEN	
7	C7	1	OPEN(1206)	OPEN	
8	C8	1	OPEN(2220)	OPEN	
9	C9	1	OPEN(2220)	OPEN	
10	C10	1	OPEN(0402)	OPEN	
11	C11	1	OPEN(1210)	OPEN	
12	C12	1	47µF±10%, 10V, X5R ceramic capacitor (1210)	MURATA GRM32ER61A476KE20	
13	C13	1	OPEN(0603)	OPEN	
14	D1	1	OPEN(DSN2)	OPEN	
15	R1	1	806kΩ ±1% resistor (0402)	VISHAY DALE CRCW0402806KFK	
16	R2	1	95.3kΩ ±1% resistor (0402)	VISHAY DALE CRCW040230K1FK	
17	R3	1	69.8kΩ ±1% resistor (0402)	PANASONIC ERJ-2RKF6982X	
18	R4	1	10kΩ ±1% resistor (0402)	VISHAY DALE CRCW040210K0FK	YAGEO RC0402FR-0710K
19	R5	1	243kΩ ±1% resistor (0402)	VISHAY DALE CRCW0402243KFK	
20	R6	1	0R ±0% resistor (0402)	PANASONIC ERJ-2GE0R00X	
21	R7	1	118kΩ ±1% resistor (0402)	PANASONIC ERJ-2RKF1183	
22	R8	1	0R ±0% resistor (0402)	PANASONIC ERJ-2GE0R00X	
23	R9	1	OPEN(0603)	OPEN	
24	FB1	1	OPEN(1206)	OPEN	
25	L1	1	OPEN(6.8µH±20%, 2.4A Inductor)	Vishay Dale (IHLP2020BZER6R8M01)	
26	U1	1	MAXM17761, 28-pin SIP Power Module	MAXM17761	
27	MECH1-MECH4	4	02-SOM25012H-00	KEYSTONE (24384)	
28	SCREW1-SCREW4	4	02-MSM25004S-00	KEYSTONE(29300)	

MAXM17761 5V Output Evaluation Kit

Evaluates: MAXM17761
5V Output-Voltage Application

MAXM17761 EV Kit Schematic

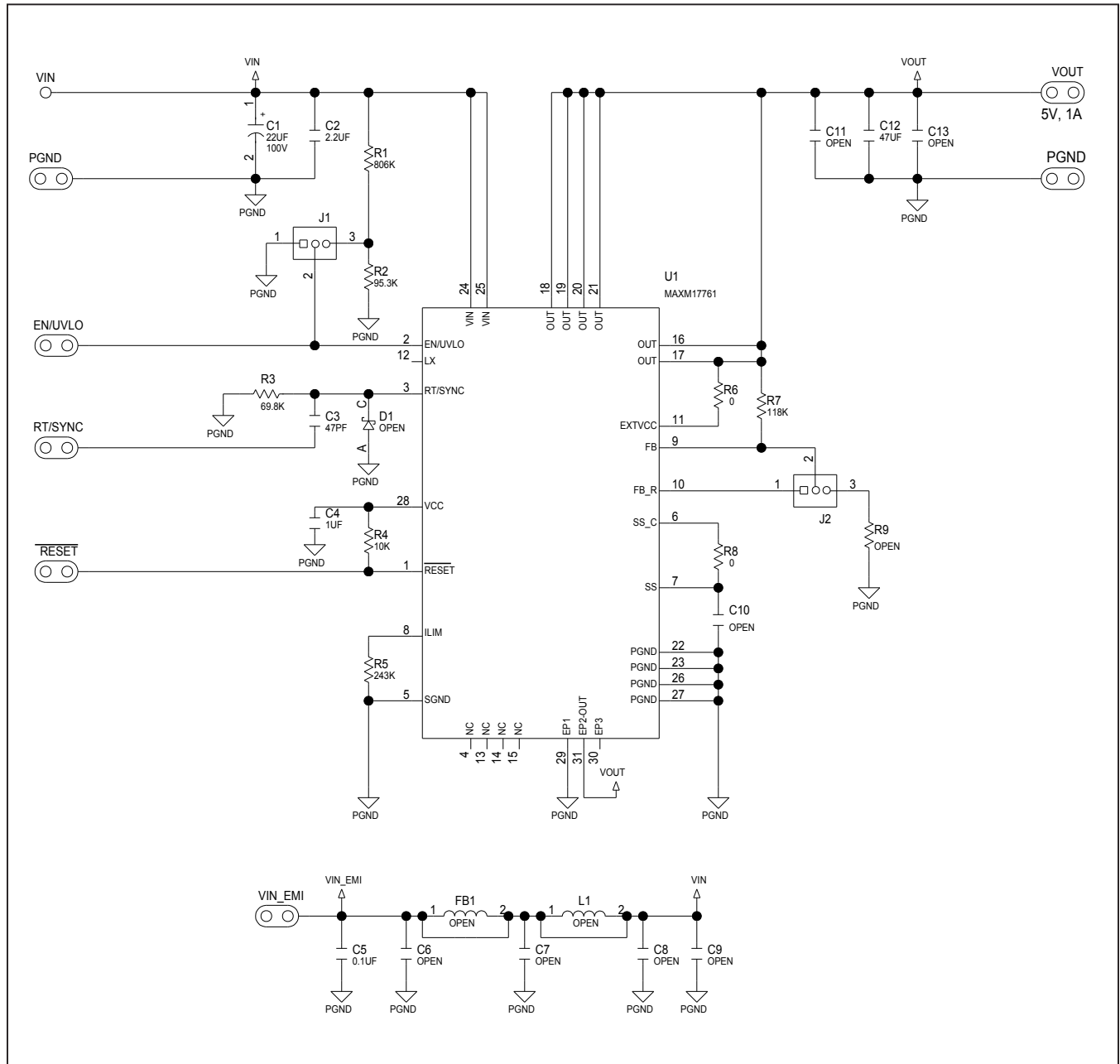

MAXM17761 5V Output Evaluation Kit

Evaluates: MAXM17761 5V Output-Voltage Application

MAXM17761 EV Kit PCB Layout Diagrams

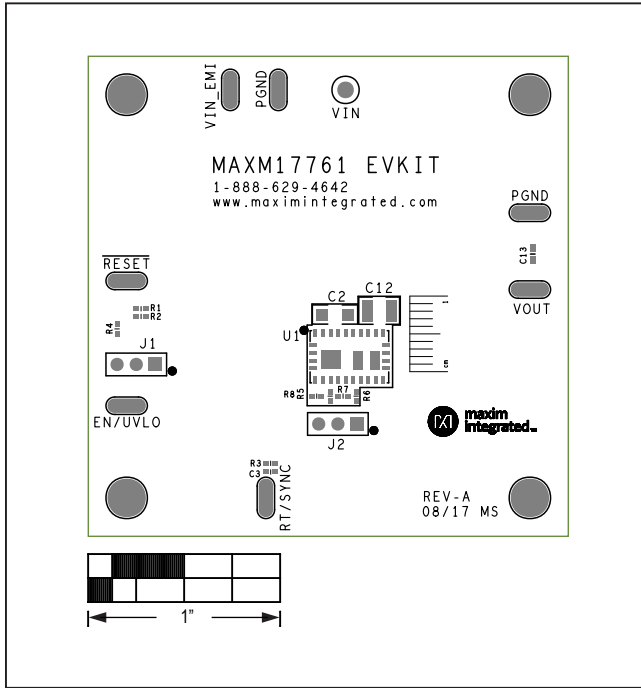

Silk Top

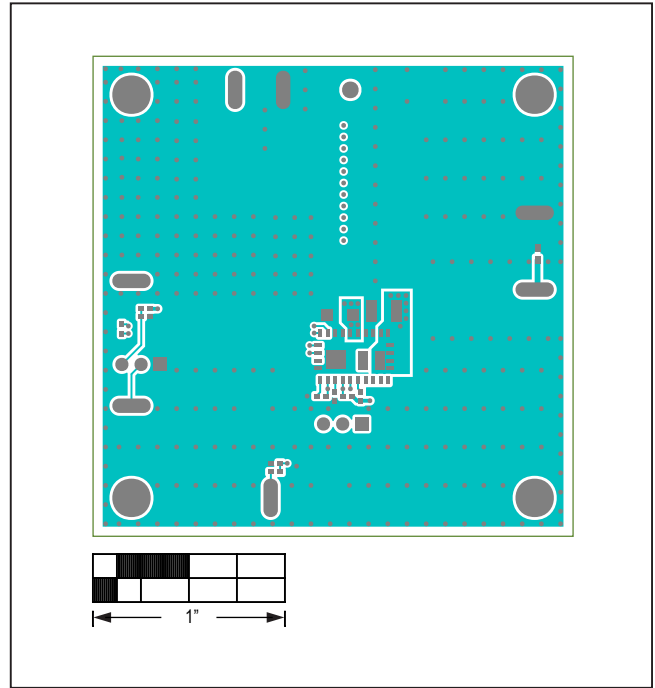

Top

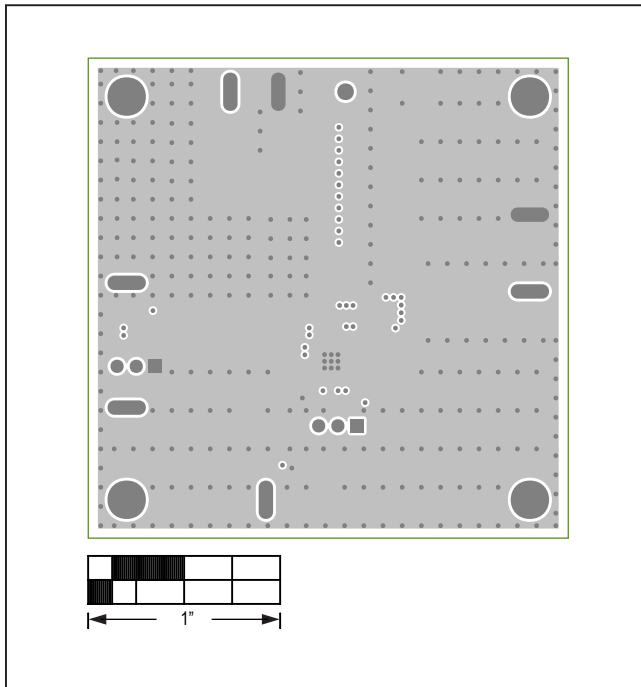

L2 GND

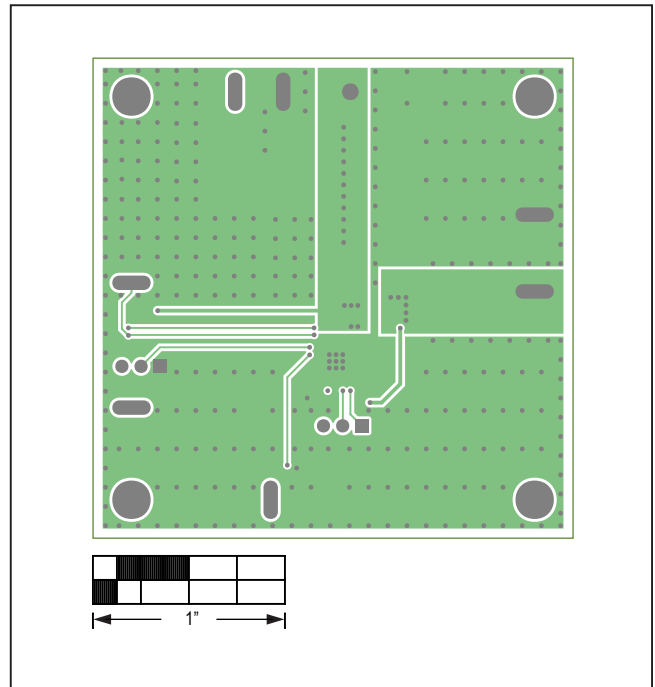

L3 PWR

MAXM17761 EV Kit PCB Layout Diagrams (continued)

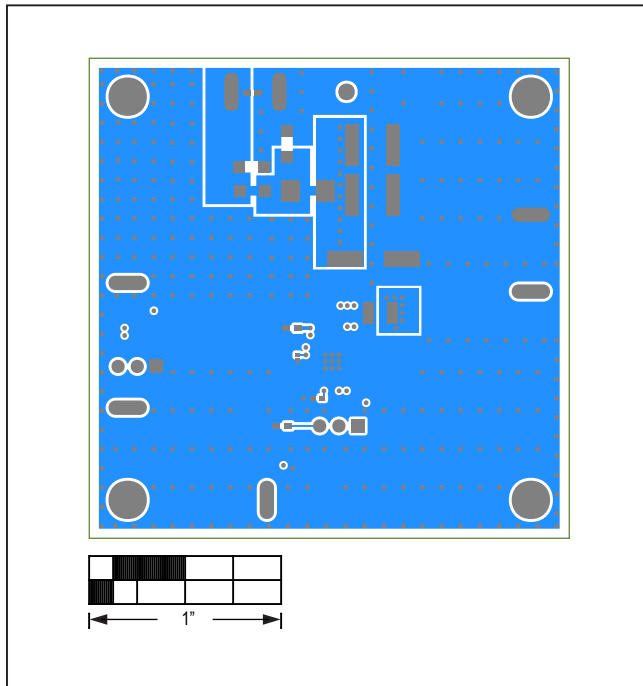

Bottom

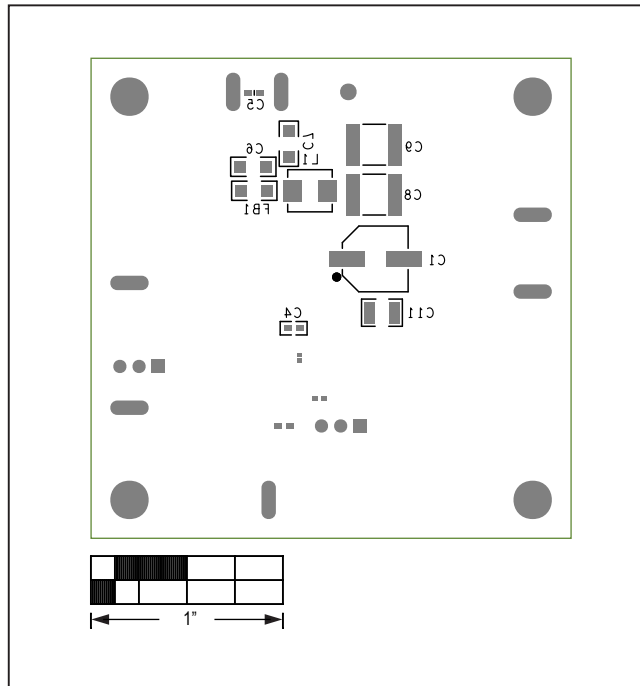

Silk Bottom

Revision History

REVISION NUMBER	REVISION DATE	DESCRIPTION	PAGES CHANGED
0	9/17	Initial release	—

For pricing, delivery, and ordering information, please contact Maxim Direct at 1-888-629-4642, or visit Maxim Integrated's website at www.maximintegrated.com.

Maxim Integrated cannot assume responsibility for use of any circuitry other than circuitry entirely embodied in a Maxim Integrated product. No circuit patent licenses are implied. Maxim Integrated reserves the right to change the circuitry and specifications without notice at any time.