

Panasonic

ideas for life

LC-P12100

For standby power supplies
 Expected trickle life: 6 years at 25°C
 10 years at 20°C



※Contents indicated (including the recycle marking, etc) are subject to change without notice.

■Dimensions(mm)

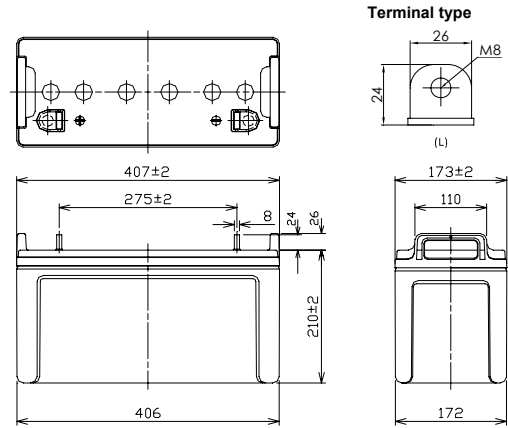

Battery case resin: Flame-retardant (UL94V-0)

■Specification

Nominal Voltage	12V	
Rated Capacity(20HR)	100Ah	
Dimensions	Length	407 mm
	Width	173 mm
	Height	210 mm
	Total height	236 mm
Approx. Mass	29.0 kg	
Terminal	M8 threaded post	

■Characteristics

Capacity (25 °C)	20 hour rate	100Ah
	10 hour rate	90Ah
	3 hour rate	76Ah
	1 hour rate	56Ah
Internal Resistance (25 °C)	Fully charged battery	5 mΩ
Temperature Dependency of Capacity (20 hour rate)	40 °C	102%
	25 °C	100%
	0 °C	85%
	-15 °C	65%
Self Discharge (25 °C)	After 3 months	91%
	After 6 months	82%
	After 12 months	64%

■Duration of discharge vs. discharge current

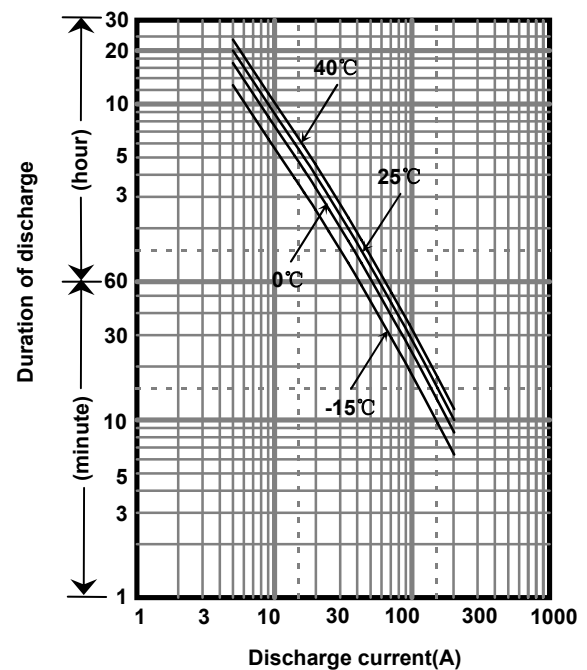

■Watt Table(25°C)

Cut-off V	(Wattage/Battery)														
	5min	10min	15min	20min	30min	45min	1h	1.5h	2h	3h	4h	5h	6h	10h	20h
9.6V	2667	2258	1920	1567	1168	868	692	493	407	280	215	175	147	92.3	47.0
9.9V	2619	2232	1900	1559	1155	847	674	480	396	275	211	169	143	89.2	47.0
10.2V	2455	2174	1862	1533	1142	839	655	471	391	270	206	164	139	88.1	46.5
10.5V	2200	2014	1732	1456	1117	826	637	461	383	265	204	164	139	87.1	46.5
10.8V	1944	1762	1584	1389	1057	796	628	439	374	260	199	159	134	86.0	45.5

■Ampere Table(25°C)

Cut-off V	(Ampere/Battery)														
	5min	10min	15min	20min	30min	45min	1h	1.5h	2h	3h	4h	5h	6h	10h	20h
9.6V	303	206	161	133	100.0	74.8	60.8	45.0	38.2	26.9	20.7	17.7	14.7	9.41	5.13
9.9V	299	204	159	131	98.9	73.0	59.9	43.9	38.0	26.4	20.6	17.2	14.7	9.41	5.03
10.2V	292	198	156	130	97.8	72.3	58.8	43.0	37.0	26.2	20.4	17.0	14.6	9.31	5.01
10.5V	270	184	145	123	95.6	71.1	57.6	42.1	35.7	25.8	20.3	16.9	14.5	9.27	5.00
10.8V	236	161	133	118	90.5	68.6	55.3	40.1	33.4	24.8	19.6	16.2	13.9	9.00	4.92

All mentioned values are average values

Charging Method (25°C)

Trickle use	Control voltage:13.6-13.8V Initial current:15.0A or smaller
-------------	--

Cut off voltage

Discharge current	5.00A-20.0A	20.0A-50.0A	50.0A-100A	100A-200A	200A-300A
Cut off voltage(V)	10.5	10.2	9.9	9.3	8.7

Influence of Temperature on Trickle life

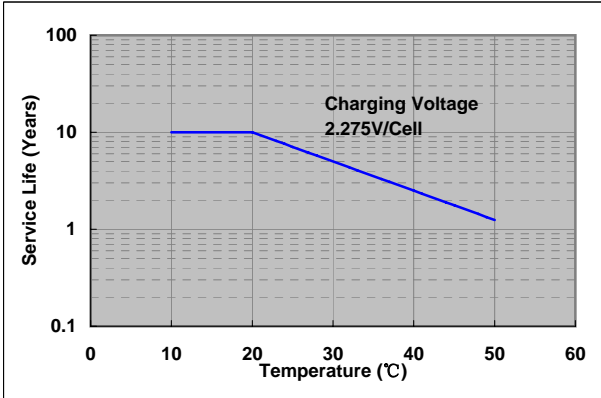

Residual capacity test result

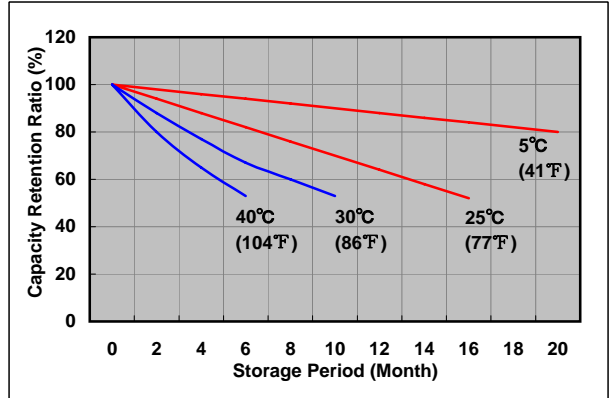

Constant-voltage constant-current charge characteristics for Trickle use

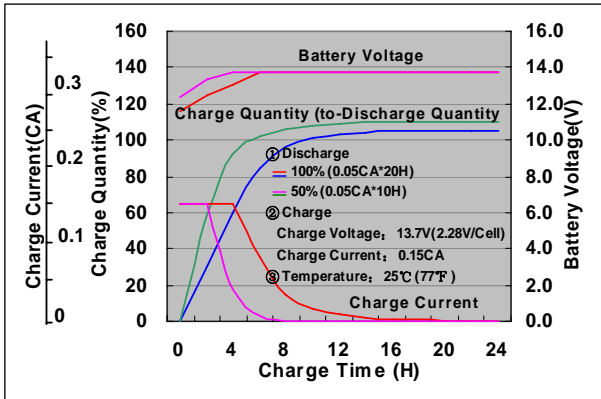

Discharge capacity by temperature and by discharge current

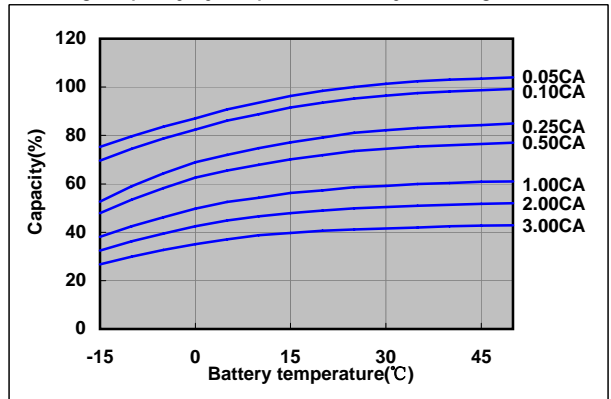

Discharge characteristics(25°C)

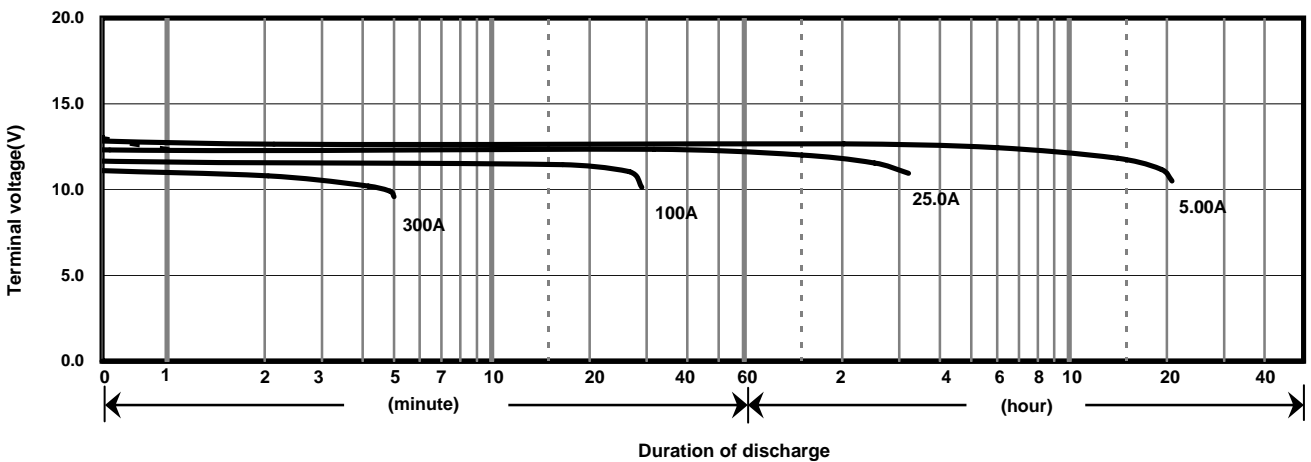

Caution

Due to the potential energy stored in the batteries, Please read 《Precautions for handling the Rechargeable Valve Regulated Lead Acid Batteries》 before using batteries. If improper handling or use of the batteries without understanding 《Precautions for handling the Rechargeable Valve Regulated Lead Acid Batteries》 may result in bodily injury caused by electrolyte leakage, heat generation, or explosion.

Panasonic Storage Battery (Shenyang) Co., Ltd

NO. 51 Kunminghu Street, Shenyang Economic & Technical Development Zone, 110141 China

Tel: 86 24 25818921

Fax: 86 24 62786318

Website: <http://www.panasonicbattery.cn>

2010.11