

Datasheet

7 Pole Male Straight DIN Connector

RS Stock number [491-065](#)



MATERIAL :

1. SHELL COVER : Zn ALLOY NICKEL PTD.
2. STRAIN BOOT : TPR
3. SET SCREW: STEEL NICKEL PTD.
4. "T" HOLDER: STEEL NICKEL PTD.
5. HOUSING : PA66
6. TERMINALS : BRASS SILVER PTD.

Drawing (mm):

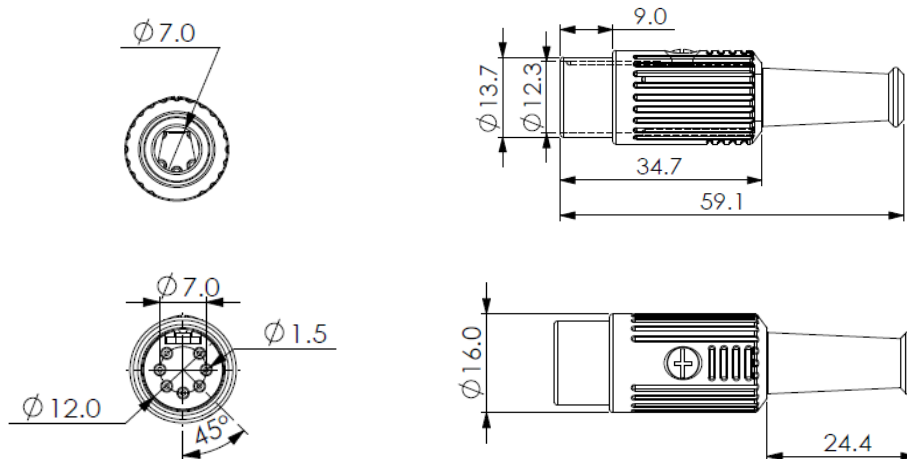

Specifications:

- rating : 100V AC 4A MAX
- contact resistance : pins-30mΩ MAX; shell-50mΩ MAX
- insulation resistance : MIN 100 MEGΩ @500V DC
- voltage withstand : 250V AC R.M.S. for 1 minute