



## Datasheet

# RS PRO Cable Clamp 7/16"

Stock number: 172-0844

EN



DIMENSIONS	TOLERANCE
<4mm	±0.20
4mm~15mm	±0.30
15mm~30mm	±0.40
30mm~50mm	±0.50

REVISIONS			
REV	DESCRIPTION	DATE	BY
01	NEW DRAWING	2016-8-28	Jack Xu

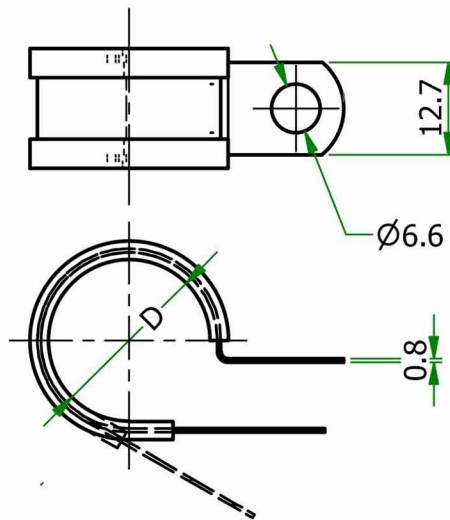

NOTES:  
 1.MATERIAL:  
 Cold Rolled Steel-- Silver  
 Cushion:RUBBER-- BLACK  
 2.HOLDING DIA. ØD=11.12mm

Unit:mm

SCALE	--	PART NAME	Hose Clamp
COLOR	SEE NOTES	PART NO.	172-0844
DRAWN	ALEX	MATERIAL	SEE NOTES
CHECK	JACK	DRAWING NO.	KS180710-5
APPROVED	GARY	DRAWING DATE	2016-8-28