

Datasheet

14 Way IDC Straight Boxed Header, 25.7mm L

RS Stock number [625-7274](#)

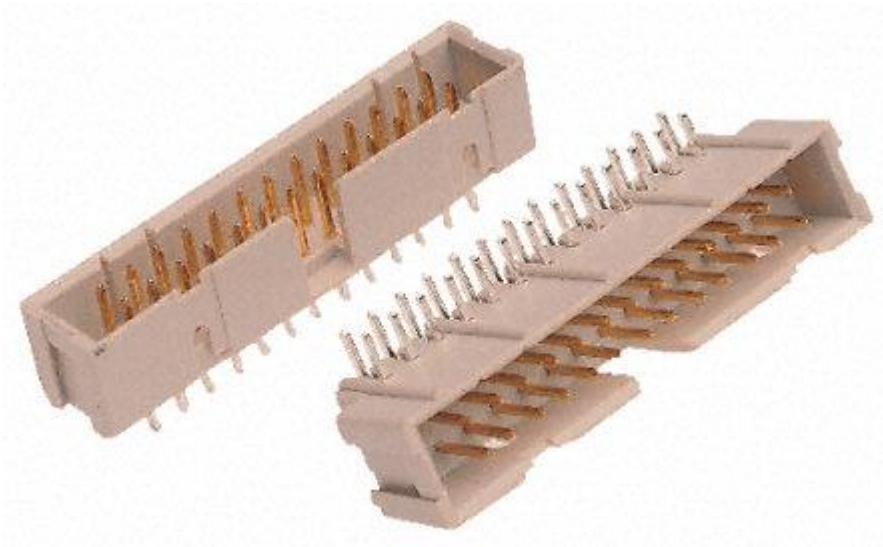

Specifications:

Housing:	30% glass filled PBT UL94V-0. Colour grey
Contacts:	Brass
Plating:	Gold plated over nickel
Current Rating:	1 amp
Insulator Resistance:	5000M Ω min. at dc 500V
Contact Resistance:	20M Ω max. at dc 100mA
Operating Temperature:	-55°C ~ +105°C

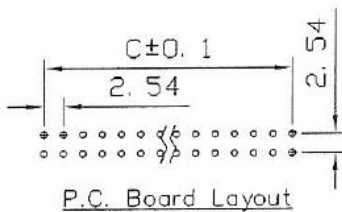
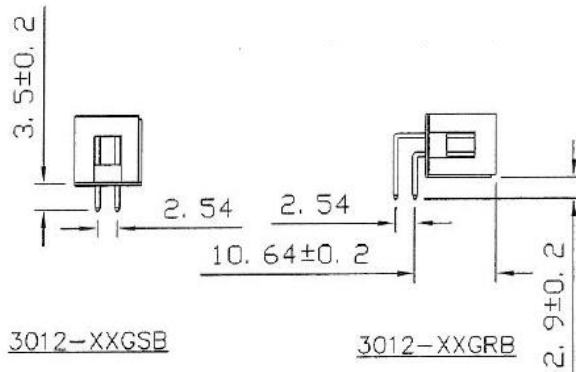
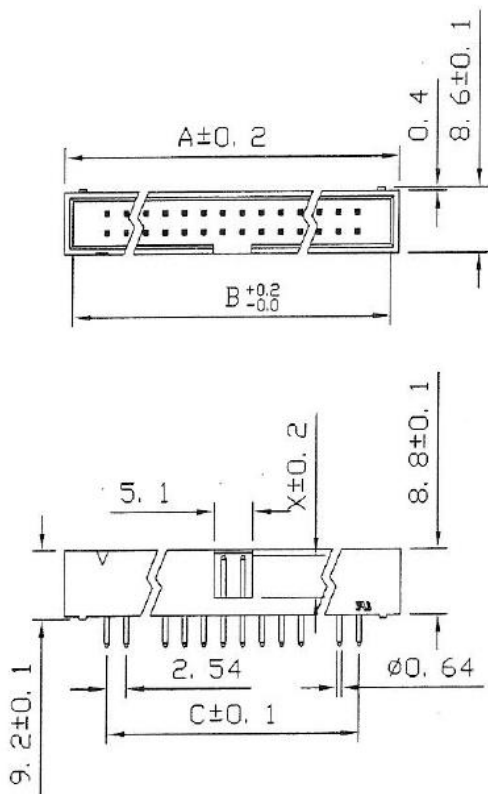

Position	Dimension		
	A	B	C
10	20.34	18.10	10.16
14	25.48	23.18	15.24
16	27.90	25.72	17.78
20	33.05	30.80	22.86
26	40.68	38.42	30.48
34	50.80	48.58	40.64
40	58.46	56.20	48.26
50	71.10	68.90	60.96
60	83.80	81.60	73.66
64	89.10	86.68	78.74