

Datasheet

ENGLISH

RS PRO WA22 Series 90 Degree Cable Mount Internally Threaded Connector

Stock No: 2107323 , 2107322



Product Details

The RS Pro WA22 series are a range of ruggedly built IP67 waterproof connectors, available in 3+PE or 6+PE configurations with internal or external threading. Versions are available for in-line cable to cable and for cable to panel connections with the plugs and receptacles being either male pins or female sockets. The WA22 series are also intermateable with similar designed connectors from other manufacturers.

Features and Benefits

- Threaded Coupling
- IP67
- Plastic
- 7 Poles
- RS Code: (2107322) = 4.5-7mm Cable OD
- RS Code: (2107323) = 7-12mm Cable OD

Technical Specifications:

Material and spec		
Number of contact	3+PE	6+PE
Contact diameter (mm)	∅2	∅1.5
Rated voltage (AC.V)	400	250
Rated current (A)	16	10
Wire size (mm ² /AWG)	≤2. 5/14	≤0. 75/18
Termination	Screw	Solder
Test voltage(AC.V)1min	2000	
Insulation resistance (MΩ)	2000	
Shell material	Nylon66, fire resistance: V-0	
Contact material	Brass with gold plating	
Temperature range	-40°C~+85°C	
Mating cycle	500	

Dimensional line drawings

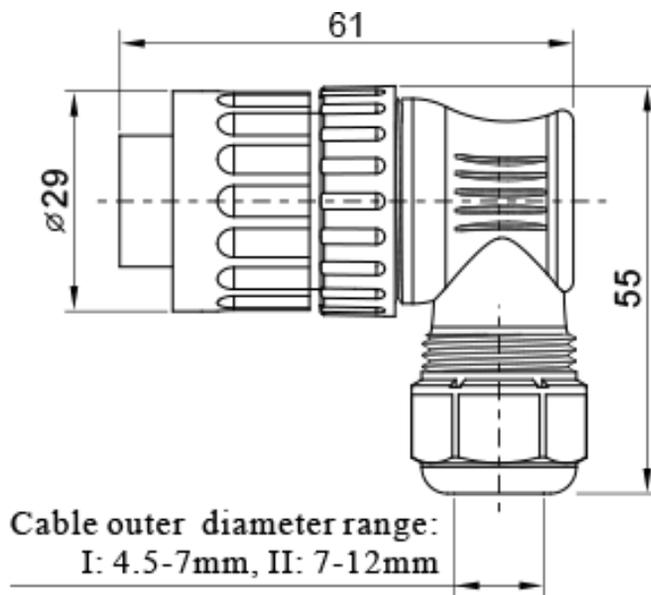

Quality Standards

