

Datasheet**RS PRO M12 Female Straight 4 Pin
D-Coded Connector, PUR Cable, 5m**

Part No: 2017098

**Technical Specifications:**

Rated Operational Voltage	250 V
Current Rating	4 A
Insulation Resistance	≥100 MΩ
Temperature Range	-25° ... +75°C
Coding	D-Coded
Degree of Protection	IP67
Grip Material	PU
Contact	Cu-Zn
Contact Plating	Gold Flash
Contact Carrier	Nylon 66
O-ring	Neoprene
Coupling Nut	Brass Nickel-Plated
Grip Colour	Black

Cable Specifications:

Cable Length-L	5 m
Cable Type	Cat5e PUR (2 x 2 Twisted Pair)
Sheath Colour	Teal
Cross Section of Wire	AWG 24
Cable Dia	6.2 ± 0.3 mm
Core Insulation	PE
Termination	Partially Stripped
Transfer Parameters	CAT5E
Transfer Rate	up to 100 Mbit/s
Shielding Details	Braiding 75% Approx.

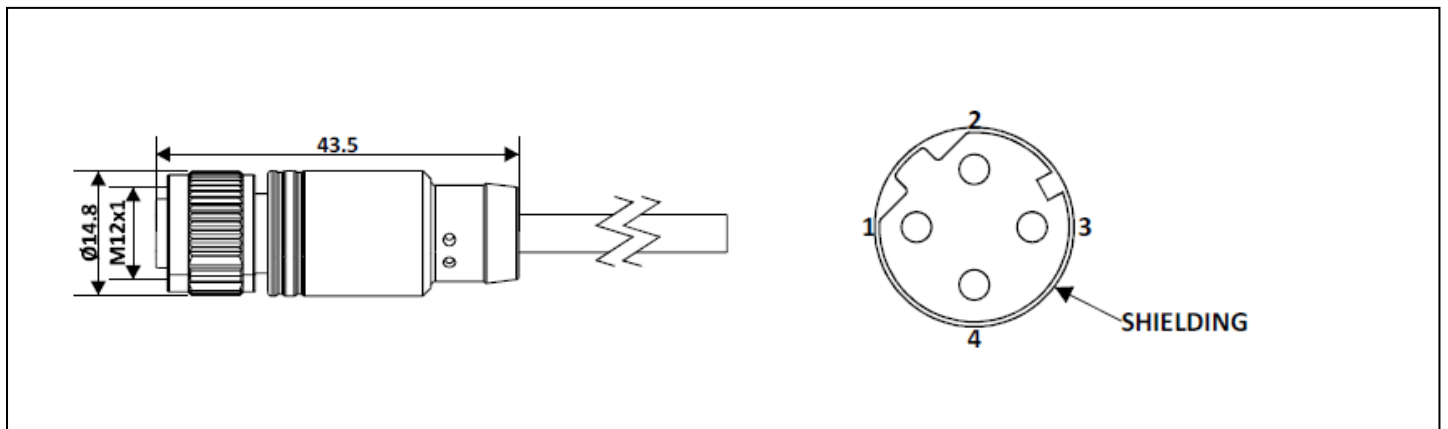

Wiring Diagram:

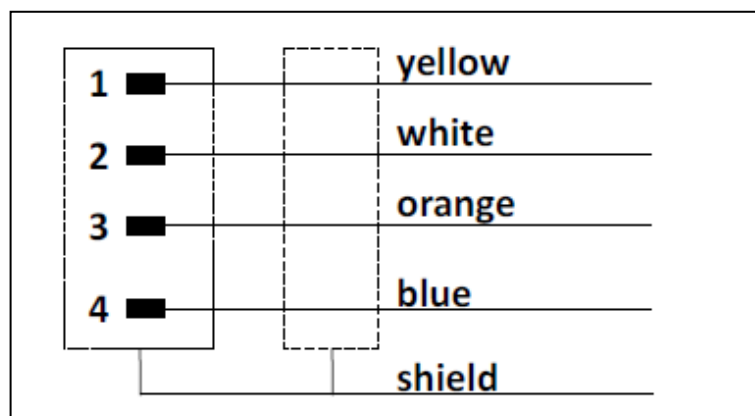

Quality Standard: IEC 61076-2-101



Type Approved
Safety
Regular Production
Surveillance



www.tuv.com
ID 111210483

