

Datasheet

RS PRO 5.0mm Pitch, 4 Ways, Euro block Header, Color: Black

Stock No: **2378461, 2378462**



Product Details:

RS PRO Series Euro Blocks are a broad range of PCB mounted terminal blocks in various sizes and profiles with pitches ranging from 15.00mm down to 3.50mm. Included are types that have wire entry from Top, Side or Side Angle. Two piece 'pluggable' versions and 'Lever Actuated' styles are also available. Each contains our unique wire guard design and is precision manufactured for smooth operation and ease of use.

Features & Benefits:

- Industry standard compatibility
- Dove tail design allows building multi-positions
- Captive screw with rising clamp design
- Euro blocks are supplied open screw "wire ready" position which shortens the time for connection.
- Available in many centerline pitch spacing.
- Available with optional high temperature insulator.
- Different color options available.

SPECIFICATION::

Material:

Insulator: PA66, rated UL 94V-0

Insulator color: Black

Clamp: Phosphor Bronze, Nickel plated

Cage: Brass, Nickel plated

Screw: M2.5 Steel, Zinc plated

Electrical:

Voltage rated: 300 V

Current rated: 10 A

Contact resistance: 20 mΩ

Insulation resistance: 500 MΩ @ 500 VDC

Wire range: 28-16AWG, 1.5mm²

Withstanding voltage: 2000V AC/1 Min

Torque: 0.4N-m, 3.6 Lb-In

Strip length: 4.5-5mm

Temperature Rating:

Operating temperature: -30°C to +120°C

Environmental:

Lead free, RoHS compliant.

Dimensional line drawings

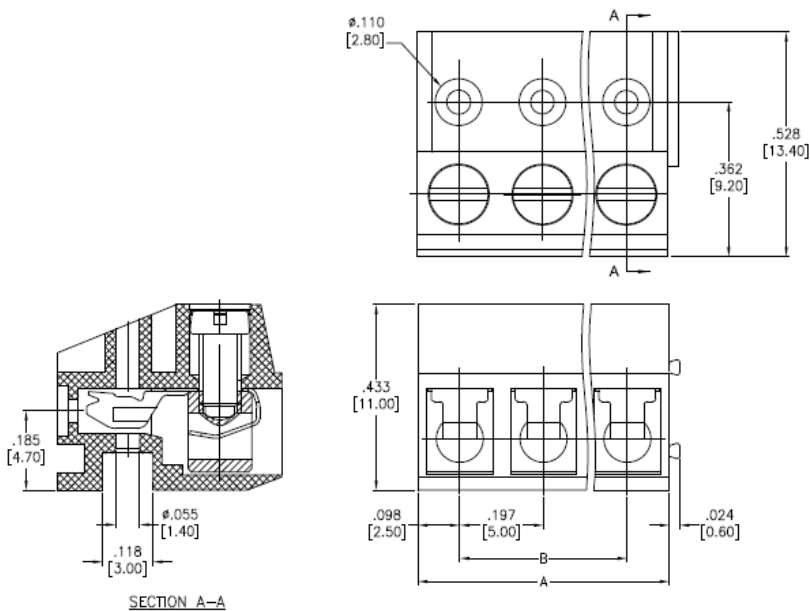

Positions: 2 thru 24

A = .197 [5.00] x No. of Positions

B = .197 [5.00] x No. of Spaces





rspro.com

