



Datasheet

RS PRO Heatsink Rack Mount enclosure

Stock number: 188-1316

EN



The HS-19 Series of rack mounted 19" heatsink enclosures is a versatile and user friendly 19" enclosure series. Designed for both professional users and home hobbyists alike, HS-19 features extruded aluminum heatsink side panels. The high grade aluminum body features removable top and bottom panels providing easy access to work inside.

Features

- Extruded heatsink side panels provide excellent cooling
- Inside face of side panels have slot for easy general purpose bar installation
- All aluminum construction
- Inner front panel for component mounting allows outer front panel to remain "clean" appearance
- "Open Frame" design maximizes user convenience for component assembly
- Heavy duty handles
- Optional mounting plates for PCB and heavy components such as transformers
- 19" rack mounted or free standing
- Flat pack for efficient storage and shipping

Standards and Materials

- Heights from 1U to 6U
- Depths of 245mm, 335mm and 425mm
- Conforms to IEC-60297-3.
- Premium grade aluminum sheet: AL 5052 and extrusion: AA 6063 (Aluminum Alloy).
- Designed and manufactured under ISO 9001:2015 and ISO 14001:2015
- All materials RoHS compliant.

HS-19 Assembly Manual (for 1U and 2U)

Item	Description	Quantity
1.	Heatsink AL Extrusion Side Frame	2
2.	Inside Front Panel AL 1.0 mm.	1
3.	AL Front Panel AL 3.0 mm.	1
4.	Nut OB 5.3x12.0 (M3)	8
5.	AL Handle	2
6.	Rear Panel AL 1.5 mm.	1
7.	Top/Bottom Cover AL 1.0 mm.	2
8.	Hex Socket Screw M5x20 BLK	4
9.	Umbrella Phillips Screw M5x10 [Dog Point]	4
10.	Umbrella Phillips Screw M3x6 [Dog Point]	12
11.	Rubber Foot	4
12.	GP-S Bar Kit [for HS-19" 1U-2U]	2

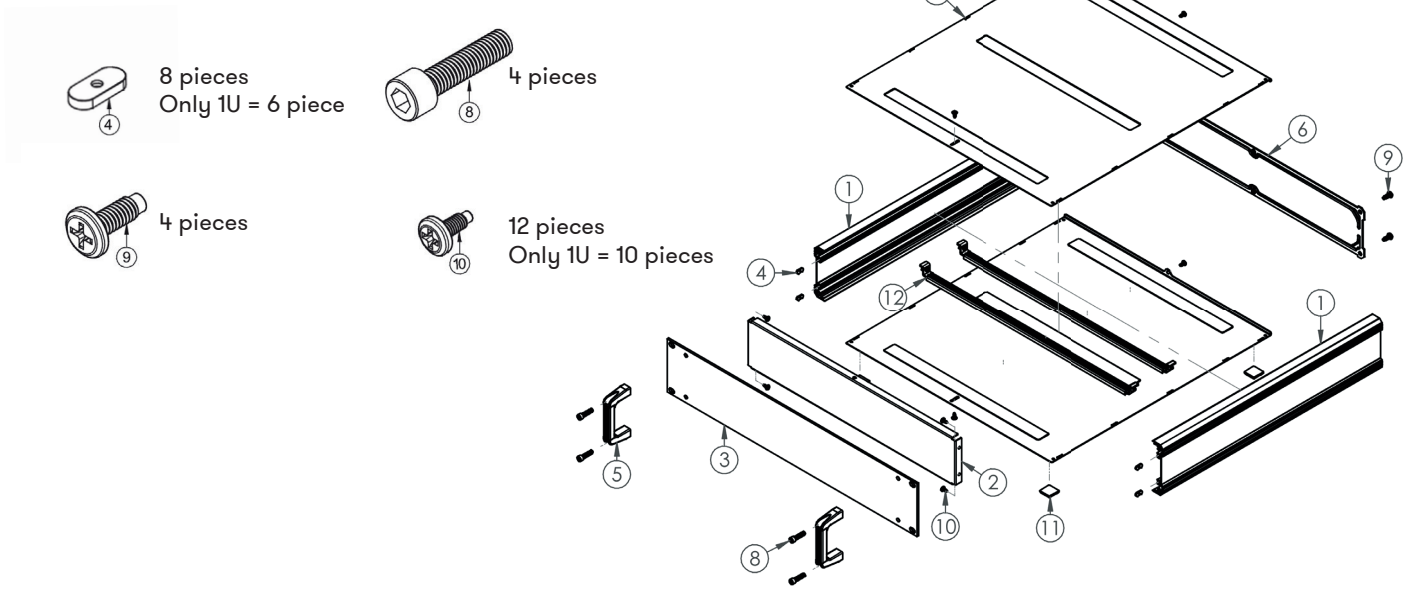

Models and Dimensions

Model	Front Panel (Pic.2&3) (AxB)	Handle (Pic.3) (GxF)	Cabinet (Pic.3) (ExDxC)
1U-D0	482.6x43.7x3	38x40	425x90x39.6
1U-D1	482.6x43.7x3	38x40	425x245x39.6
1U-D2	482.6x43.7x3	38x40	425x335x39.6
1U-D3	482.6x43.7x3	38x40	425x425x39.6
2U-D1	482.6x88.1x3	82.4x40	425x245x84.0
2U-D2	482.6x88.1x3	82.4x40	425x335x84.0
2U-D3	482.6x88.1x3	82.4x40	425x425x84.0

(Unit: mm.)

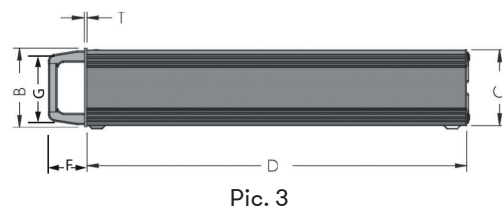
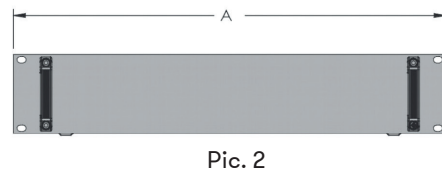
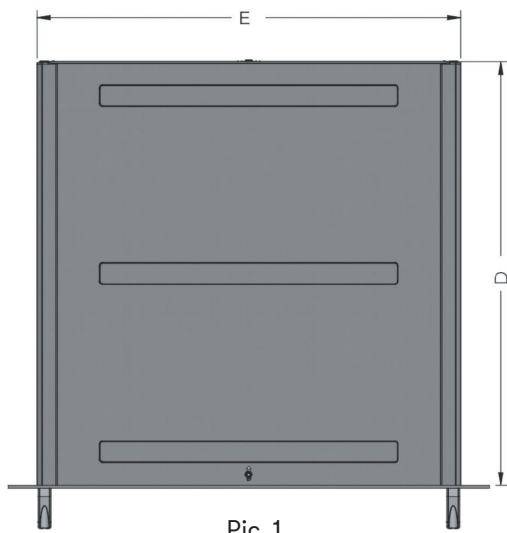

Applications



Mounting Electronic Component on Heatsink

Mounting PSU for component on the GP Bar

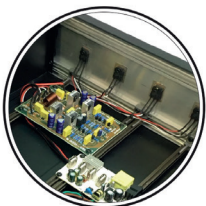
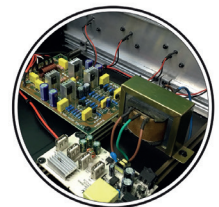

Mounting PCB on the GP bar and Mounting Electronic Component on Heatsink

Assembly Guide

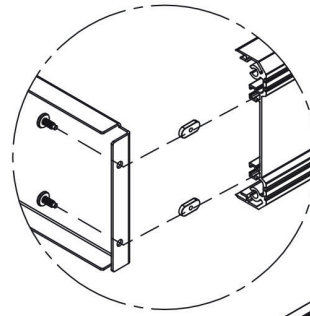
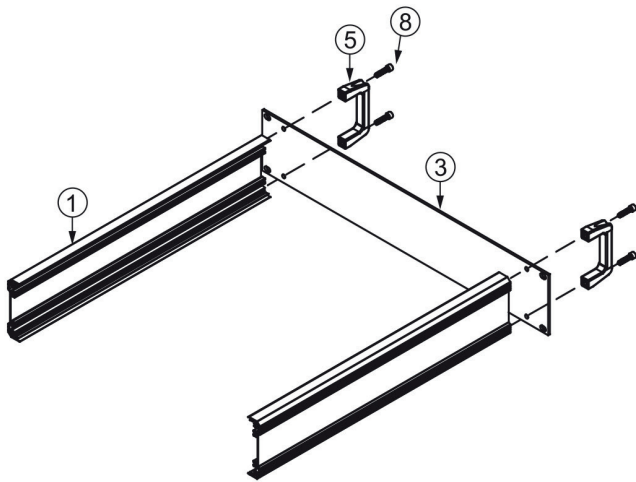

DETAIL A

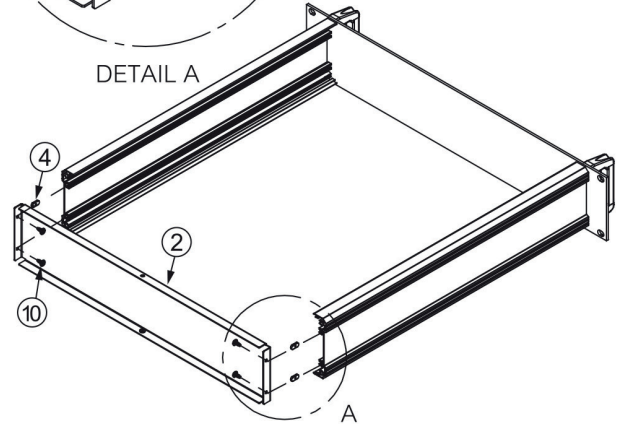

1. Install ⑤ AL handle and ③ AL front panel to ① Heatsink AL Extrusion side frame with ⑧ Hex socket screw M5x20 [4].

2. Insert ④ Nut OB M3 [4] into the rail slot on Heatsink AL Extrusion side frame then install ② inside front panel secure with ⑩ Umbrella Phillips screw M3x6 (Dog Point) [4] [only 1U nut OB and screw used 2 pieces]

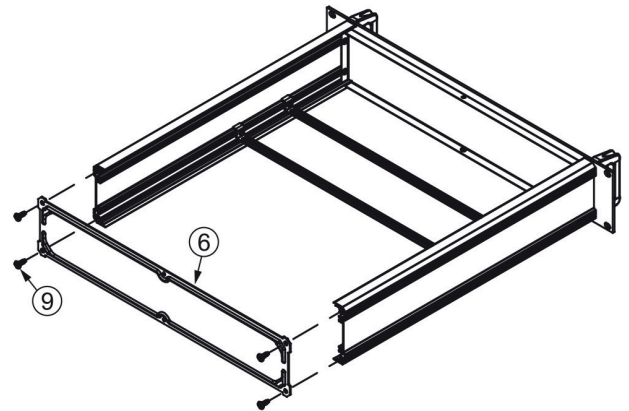
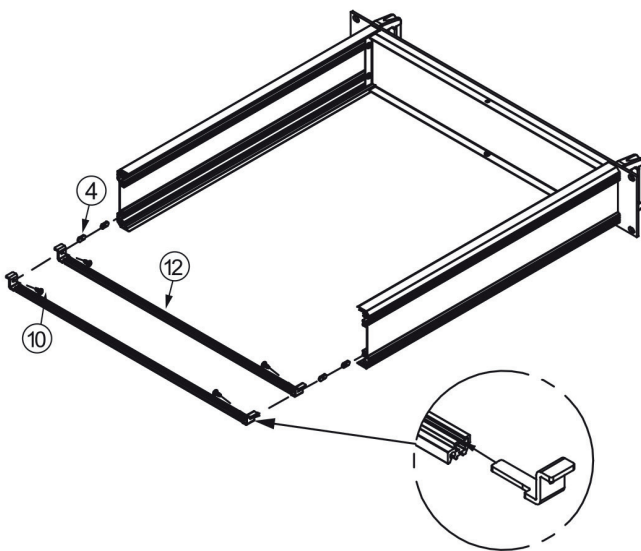

3. Insert ④ Nut OB M3[4] into the rail slot on Heatsink AL Extrusion side frame at the bottom. Install ⑫ GP Bar [2] secure with ⑩ Umbrella Phillips screw M3x6 (Dog Point) [4].

4. Install ⑥ rear panel cover and tie with ⑨ Umbrella Phillips screw M3x6 (Dog Point) [4]. [Convex shape is outside, see detail A in item 5]

Note: Location of GP Bar per user requirement. Additional GP Bar can be purchased separately.

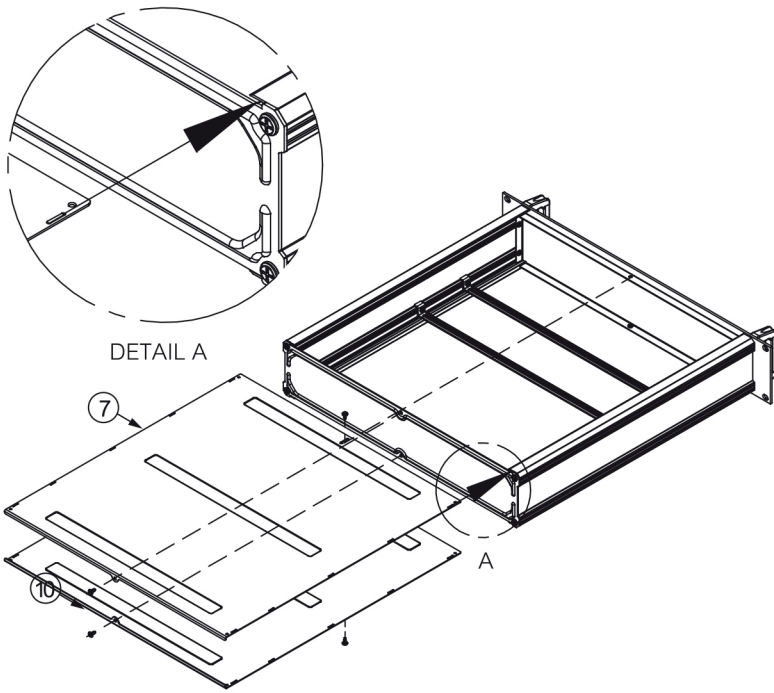

5. Slide ⑦ Top/Bottom cover and into slot on side frame and fasten with ⑩ Umbrella Phillips screw M3x6 (Dog Point) [4]

* GP-S Bar is also an optional component you can order extra.

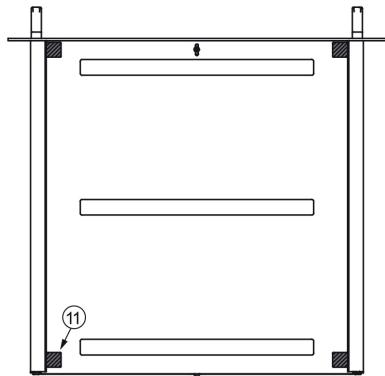

6. Place the ⑪ rubber foot at the bottom of box.

* Clean surface before placing rubber foot. Isopropyl Alcohol 70% is recommended.

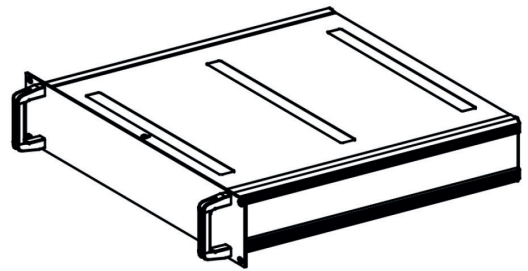

7. Completed assembly

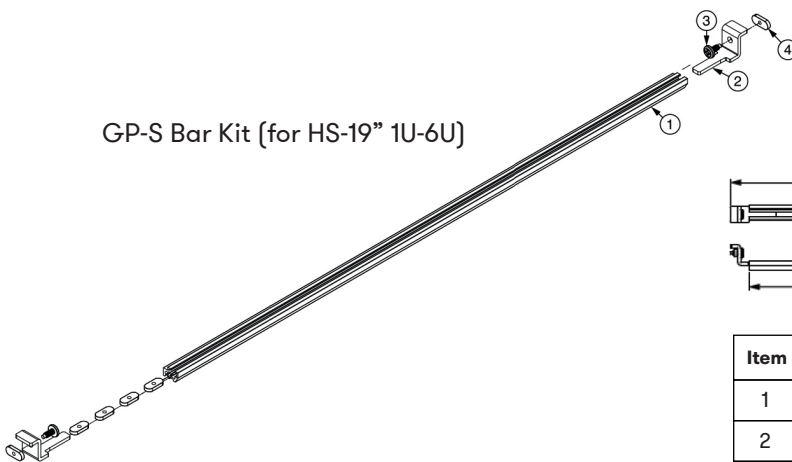

GP-S Bar Kit (for HS-19" 1U-6U)

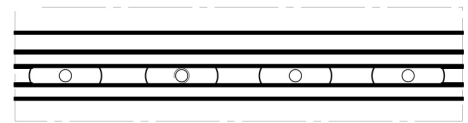

Detail A

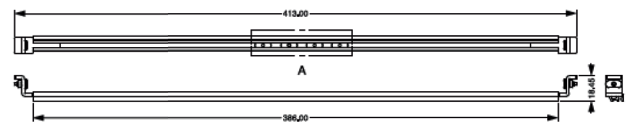

Item	Part Name	Quantity
1	AL Bar 1U-2U	1
2	Bar support Brkt.	2
3	Umbrella Phillips screw M3x6 (Dog Point)	2
4	Nut OB 5.3x12.0 (M3)	6

Specifications

Attribute	Value
Product 188-1316	HS-19 2U- 425W-245D
External Width	425mm
External Depth	245mm
External Height	84mm
External Dimensions	425 x 245 x 84
Body Material	Aluminum Extrusion
IP Rating	IP30
Color	Black
Lid Color	Black
Flanged	No
Shielded	No
Gasket Material	No
Standard Met	ROHs Compliant
Application	Electrical, Electronic, Industrial