

Datasheet

Stainless Steel Male Clamping Handle

RS Stock No: 1443620

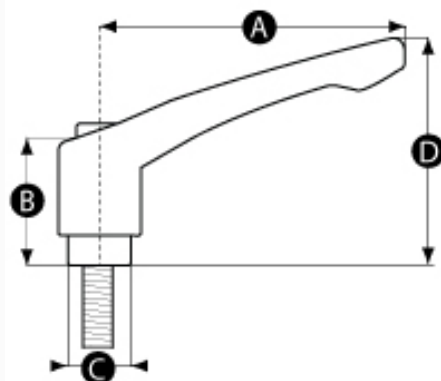

Specification

Handle material: Stainless steel - 304

Thread, ratchet and spring: Stainless steel - 304

Stock no	A	B	C	D	Thread size	Thread length (mm)
1443604	42	18	10	34	M6	20
1443605	42	18	10	34	M6	32
1443606	42	18	10	34	M6	40
1443607	65	21	14	44	M8	16
1443608	65	21	14	44	M8	20
1443609	65	21	14	44	M8	25
1443610	65	21	14	44	M8	32
1443611	65	21	14	44	M8	40
1443612	65	21	14	44	M8	50
1443613	78	24	16	51	M10	20
1443614	78	24	16	51	M10	32
1443615	78	24	16	51	M10	40
1443616	78	24	16	51	M10	50
1443617	78	24	16	51	M10	63
1443618	92	28	19	60	M12	25
1443619	92	28	19	60	M12	32
1443620	92	28	19	60	M12	40
1443621	92	28	19	60	M12	63