

Datasheet

RS PRO 5.08mm Pitch, 3 Ways, Right Angle Euro block Header, Through Hole PCB, Closed Sides

Stock No: 2378529, 2378530



Product Details:

RS PRO Series Euro Blocks are a broad range of PCB mounted terminal blocks in various sizes and profiles with pitches ranging from 15.00mm down to 3.50mm. Included are types that have wire entry from Top, Side or Side Angle. Two piece 'pluggable' versions and 'Lever Actuated' styles are also available. Each contains our unique wire guard design and is precision manufactured for smooth operation and ease of use.

Features & Benefits:

- Industry standard compatibility
- Dove tail design allows building multi-positions
- Captive screw with rising clamp design
- Euro blocks are supplied open screw "wire ready" position which shortens the time for connection.
- Available in many centerline pitch spacing.
- Available with optional high temperature insulator.
- Different color options available.

SPECIFICATION:

Material:

Insulator: PA66, rated UL 94V-0

Insulator color: Green

Contacts: Copper Alloy, Tin plated

Electrical:

Voltage rated: 300 V

Current rated: 15 A

Withstanding voltage: 1600V AC/1 Min

Temperature Rating:

Operating temperature: -40°C to +105°C

Environmental:

Lead free, RoHS compliant.

Dimensional line drawings

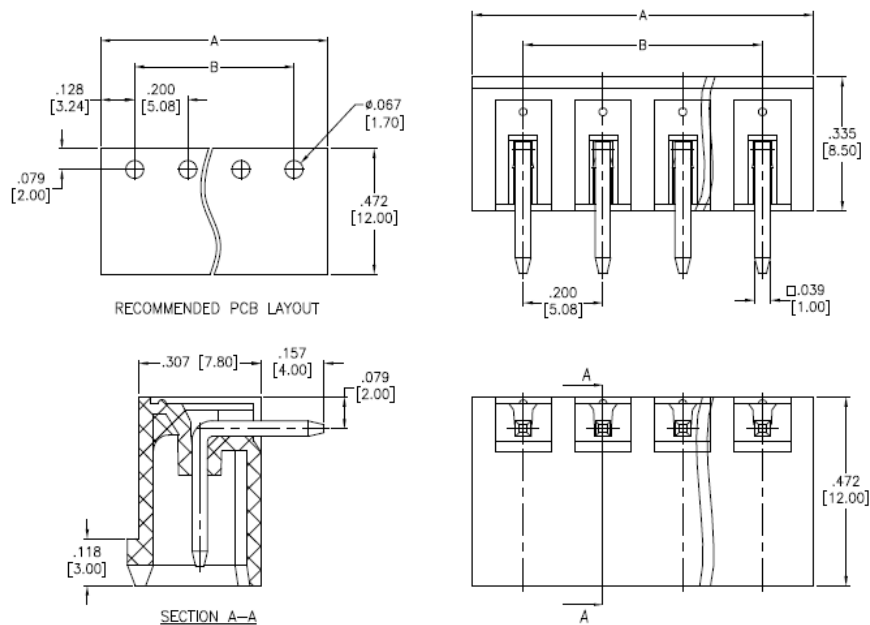

Positions: 02 thru 24

$A = .200$ [5.08] x No. of Positions + $.055$ [1.40]

$B = .200$ [5.08] x No. of Spaces



rspro.com

