



Datasheet

RS PRO Foot 1.3 to 2.3mm thick

Stock number: 172-0877

EN



DIMENSIONS	TOLERANCE
<4mm	±0.15
4mm~15mm	±0.20
15mm~30mm	±0.30
30mm~50mm	±0.50
50mm~100mm	±1.00

REVISIONS			
REV	DESCRIPTION	DATE	BY
01	NEW DRAWING	2016-9-16	Jack Xu

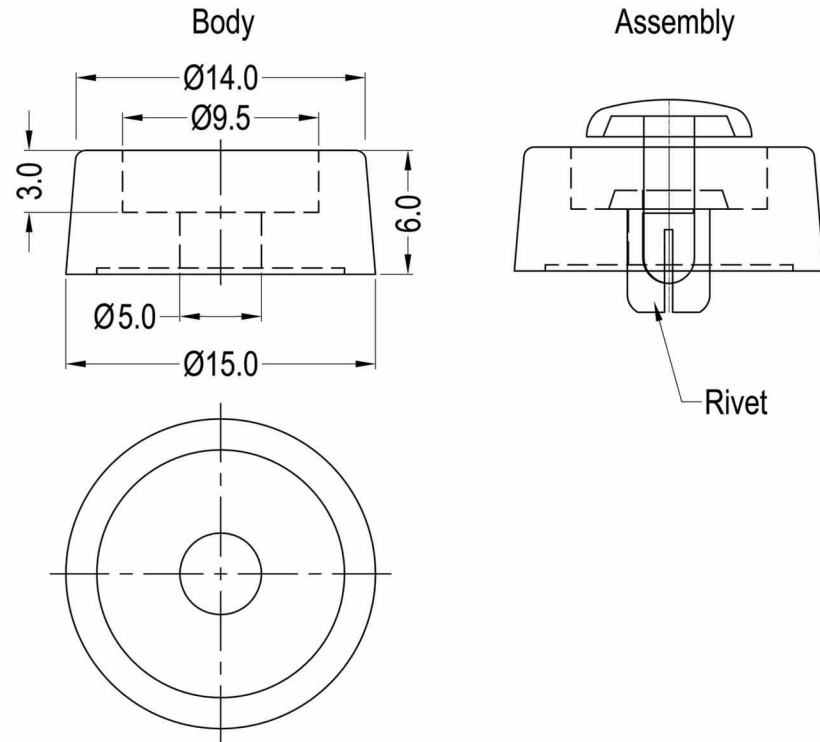

NOTES:

1.MATERIAL: TPV UL94 HB(Body)
PA6 UL94 V2(Rivet)

2.Hole:Ø5.1~5.2mm

Panel Thickness:1.3~2.3mm

Mounting Rivet R5075B

Unit:mm

	SCALE	2:1	PART NAME	Soft Fast Foot
	COLOR	BLACK	PART NO.	172-0877
	DRAWN	ALEX	MATERIAL	SEE NOTES
	CHECK	JACK	DRAWING NO.	KS180714-5
	APPROVED	FRED	DRAWING DATE	2016-9-16