

# Toggle Switch Sealed SPDT

**multicomp** PRO

**RoHS  
Compliant**

## Specifications

Mechanical Life : 30,000 make-and-break cycles.  
 Contact Resistance : 20 mΩ max. initial @ 2-4V DC  
 Insulation Resistance : 1,000 MΩ min.  
 Dielectric Strength : 1,500 Vrms min.@sea level.  
 Operating Temperature : -30°C to 85°C.  
 Rating : 12 Amps @125/250V AC.

## Materials

Contact Plating : Silver  
 Terminal Plating : Nickel  
 Case : Diallyl phthalate (Nylon) (UL94V-0).  
 Actuator : Brass, Chrome Plated.  
 Bushing : Zin+Silicon  
 Terminal/Contact : Copper

## Diagram

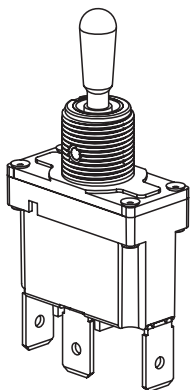
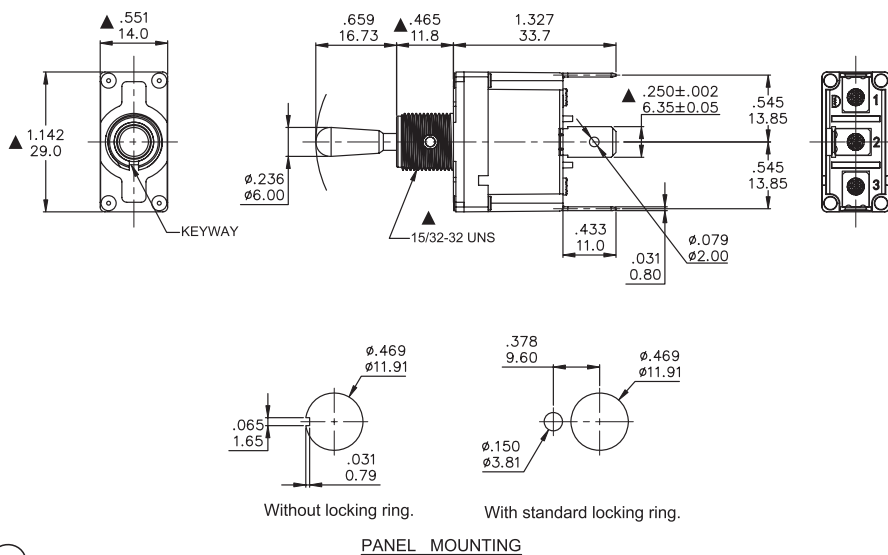

Dimensions : Inches (Millimetres)

## Switch Function

Model	Pos.1	Pos.2	Pos.3
MP1HAS4T1B1M2N1S-5	ON	OFF	ON
Term. Comm.	2-3	OPEN	2-1
Schematic			

Newark.com/multicomp-pro  
 Farnell.com/multicomp-pro  
 sg.element14.com/b/multicomp-pro

**multicomp** PRO

# Toggle Switch

## Sealed SPDT

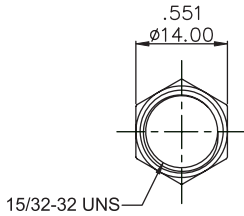

NUT

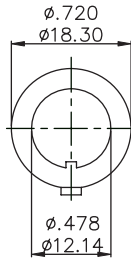
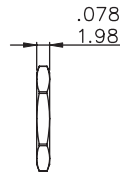

LOCKING RING

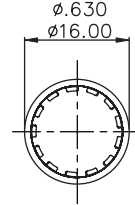
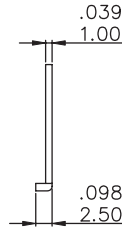

LOCKING WASHER

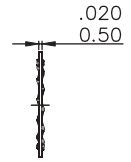

Sl. No.	Part Name	Qty.	Material
1	15/32-32 Inch Nut	2	C3604, Nickel Plated
2	Locking Ring	1	SPCC, Zinc Blue Plated
3	Locking Washer		Stainless Steel.

Dimensions : Inches (Millimetres)

### Part Number Table

Description	Part Number
Toggle Switch, Quick Disconnect Terminal, (ON)-OFF-(ON), SPDT	MP1HAS4T1B1M2N1S-5

**Important Notice :** This data sheet and its contents (the "Information") belong to the members of the AVNET group of companies (the "Group") or are licensed to it. No licence is granted for the use of it other than for information purposes in connection with the products to which it relates. No licence of any intellectual property rights is granted. The Information is subject to change without notice and replaces all data sheets previously supplied. The Information supplied is believed to be accurate but the Group assumes no responsibility for its accuracy or completeness, any error in or omission from it or for any use made of it. Users of this data sheet should check for themselves the Information and the suitability of the products for their purpose and not make any assumptions based on information included or omitted. Liability for loss or damage resulting from any reliance on the Information or use of it (including liability resulting from negligence or where the Group was aware of the possibility of such loss or damage arising) is excluded. This will not operate to limit or restrict the Group's liability for death or personal injury resulting from its negligence. Multicomp Pro is the registered trademark of Premier Farnell Limited 2019.