

RoHS  
Compliant

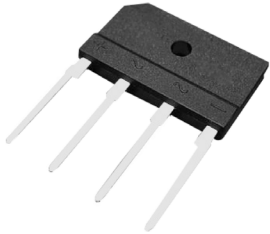

## Features

- Glass passivated
- Ideal for printed circuit board
- Low forward voltage drop, high current capability

## Specifications

Reverse Voltage : 600 Volts  
Forward Current : 6 Amperes

## Maximum Ratings and Electrical Characteristics

Rating at 25°C ambient temperature unless otherwise specified.  
Single phase, half wave, 60Hz, resistive or inductive load.  
For capacitive load, derate current by 20%.

Characteristics	Symbol	Values	Unit
Max. Recurrent Peak Reverse Voltage	$V_{RRM}$	600	V
Max. RMS Voltage	$V_{RMS}$	420	
Max. DC Blocking Voltage	$V_{DC}$	600	
Max. Average Forward (with heatsink Note 2) Rectified Current at $T_c = 100^\circ\text{C}$ (without heatsink)	$I_{(AV)}$	6 2.8	A
Peak Forward Surge Current 8.3ms Single Half Sine-Wave Super Imposed on Rated Load (JEDEC Method)	$I_{FSM}$	150	
Max. Forward Voltage at 4 A DC	$V_F$	1.1	V
Max. DC Reverse Current at $T_J = 25^\circ\text{C}$ at Rated DC Blocking Voltage at $T_J = 125^\circ\text{C}$	$I_R$	10 500	$\mu\text{A}$
$I^2t$ Rating For Fusing ( $t < 8.3\text{ms}$ )	$I^2t$	120	$\text{A}^2\text{s}$
Typical Junction Capacitance per Element (Note 1)	$C_J$	55	pF
Typical Thermal Resistance (Note 2)	$R_{\theta JC}$	1.8	$^\circ\text{C} / \text{W}$
Operating Temperature Range	$T_J$	-55 to +150	$^\circ\text{C}$
Storage Temperature Range	$T_{STG}$		

**Note:** 1. Measured at 1MHz and applied reverse voltage of 4 V DC  
2. Device mounted on 75mm × 75mm × 1.6mm Cu plate heatsink

## Rating and Characteristic Curves

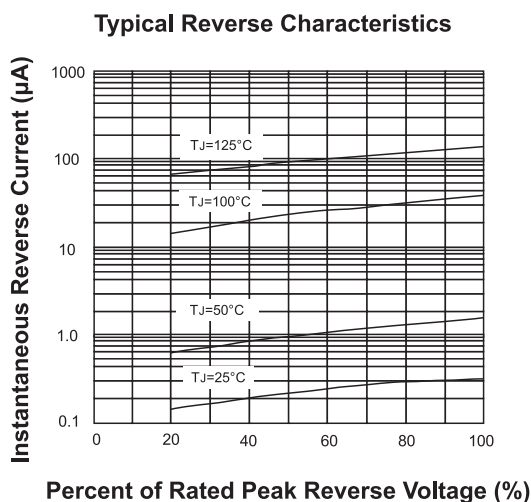
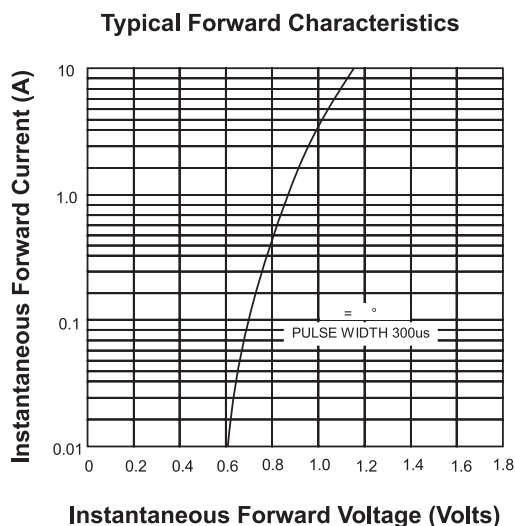
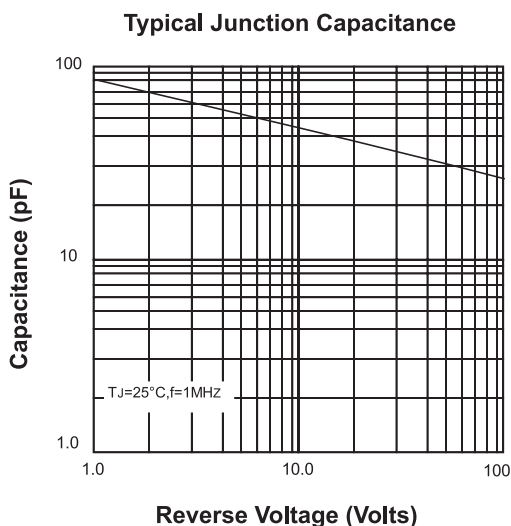
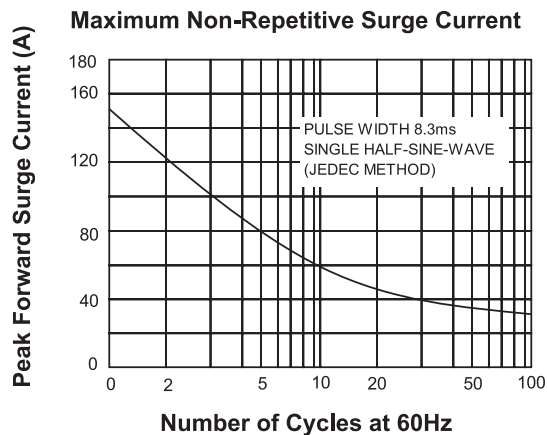
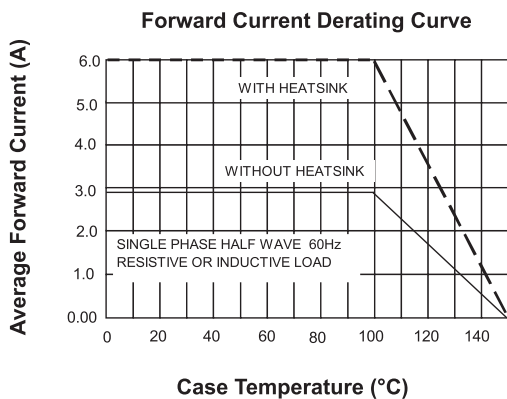

## Diagram

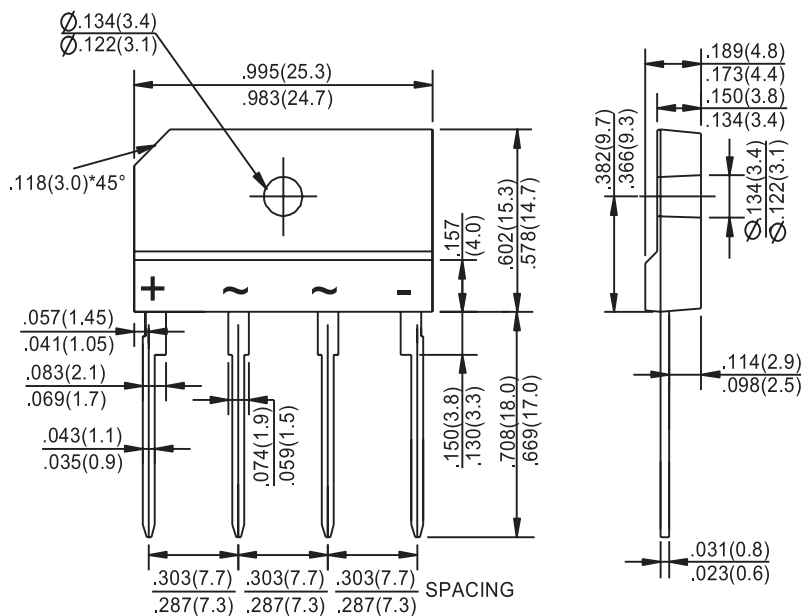

Dimensions : Inches (Millimetres)

## Part Number Table

Description	Part Number
Bridge Rectifier, 600V, 6A	VSIB660

**Important Notice :** This data sheet and its contents (the "Information") belong to the members of the AVNET group of companies (the "Group") or are licensed to it. No licence is granted for the use of it other than for information purposes in connection with the products to which it relates. No licence of any intellectual property rights is granted. The Information is subject to change without notice and replaces all data sheets previously supplied. The Information supplied is believed to be accurate but the Group assumes no responsibility for its accuracy or completeness, any error in or omission from it or for any use made of it. Users of this data sheet should check for themselves the Information and the suitability of the products for their purpose and not make any assumptions based on information included or omitted. Liability for loss or damage resulting from any reliance on the Information or use of it (including liability resulting from negligence or where the Group was aware of the possibility of such loss or damage arising) is excluded. This will not operate to limit or restrict the Group's liability for death or personal injury resulting from its negligence. Multicomp Pro is the registered trademark of Premier Farnell Limited 2019.