





Cylinder Screw  
M4 x 20/7 similar to DIN 84

**GENERAL SPECIFICATION AND AREA CLASSIFICATION:**

1. MATERIAL COMPOSITION - AISI 12
  2. DEGREE OF PROTECTION IP66 AS PER IEC 60529 : 1989 +A1 : 2000
  3. SERVICE TEMPERATURE RANGE : - 50 °C to +135 °C
  4. ALL DIMENSIONS ARE IN mm. UNLESS STATED OTHERWISE.
  5. SURFACE WILL PLAIN FINISH OR POWDER COATED.(RAL-7001)
  6. THE JUNCTION BOX WILL BE MARKED WITH
  7.  II 2 G Ex e IIC Gb  
 II 2 D Ex tb III C Db IP 66  
**0539**  
DEMKO 13 ATEX 1327771U  
IECEX UL 13.0042U
  8. TRADE MARK 
-  NOT TO BE REVISED WITHOUT NOTIFICATION TO THE ExCB/NOTIFIED BODY

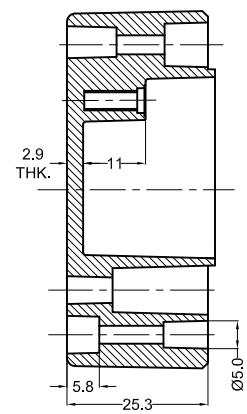
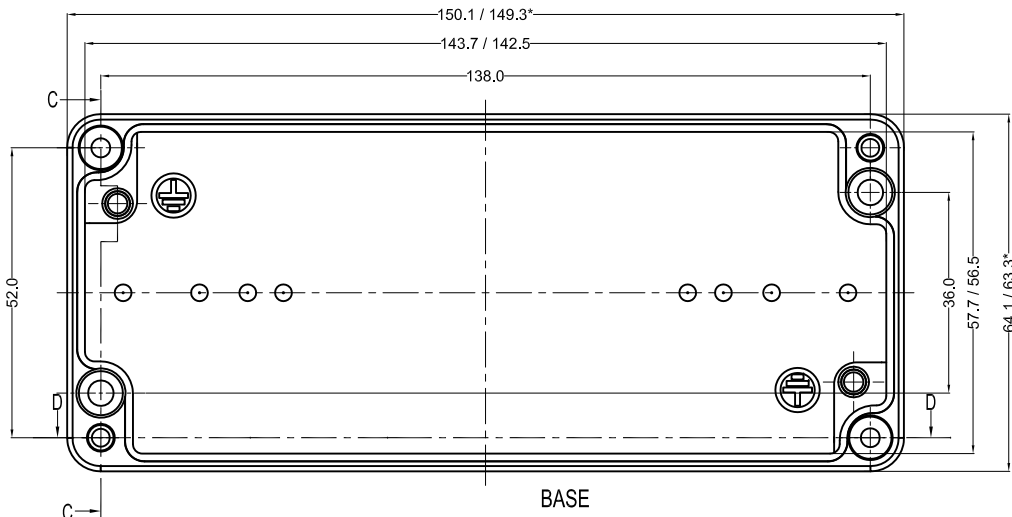
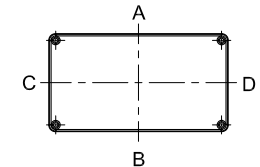
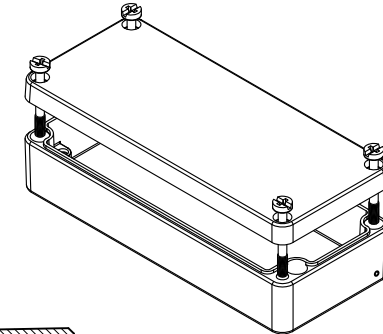
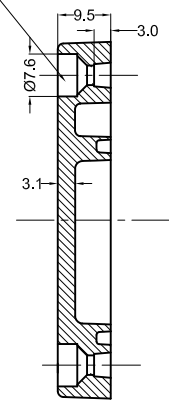
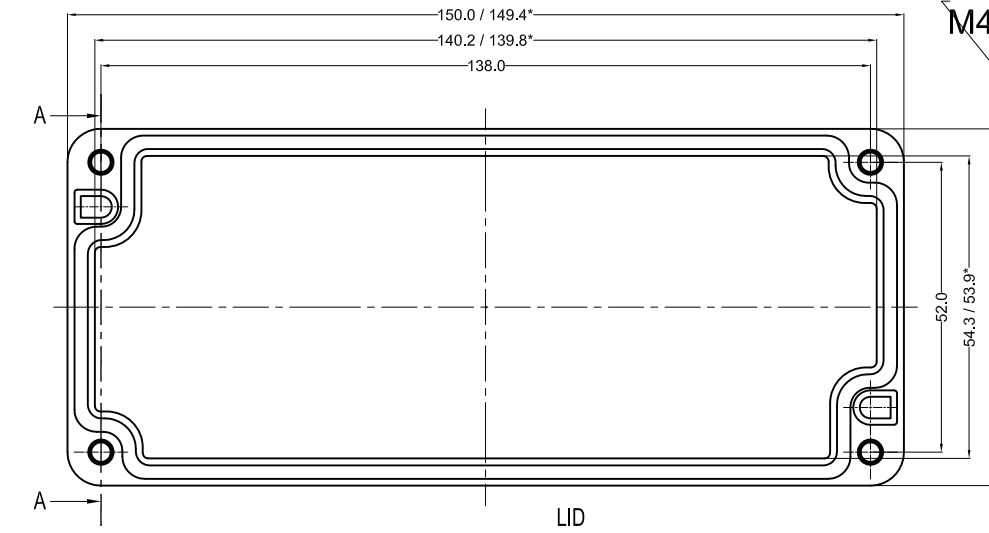

Opening Detail (Size)	NO OF HOLES SIDE A/B	Min. Distance between the opening for Side A/B (mm)	NO OF HOLES SIDE C/D	Min. Distance between the opening for Side C/D (mm)	Opening Detail (Size) PG	NO OF HOLES SIDE A/B	Min. Distance between the opening for Side A/B (mm)	NO OF HOLES SIDE C/D	Min. Distance between the opening for Side C/D (mm)	Min. Distance of last opening from the enclosure end on side A/B (mm)	Min. Distance of last opening from the enclosure end on side C/D (mm)
M12	7	7	1	-	Pg.7	7	7	1	-	14	23
M16	-	-	-	-	Pg.9	6	10	1	-	15	23
M20	-	-	-	-	Pg.11	-	-	-	-	-	-
M25	-	-	-	-	Pg.13.5	-	-	-	-	-	-
M32	-	-	-	-	Pg.16	-	-	-	-	-	-
M40	-	-	-	-	Pg.21	-	-	-	-	-	-
M50	-	-	-	-	Pg.29	-	-	-	-	-	-
M63	-	-	-	-	Pg.36	-	-	-	-	-	-
-	-	-	-	-	Pg.42	-	-	-	-	-	-
-	-	-	-	-	Pg.48	-	-	-	-	-	-

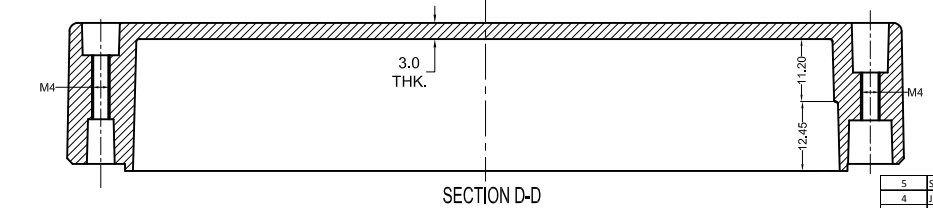

SR.NO.	PART NAME	DRAWING NO.	MATERIAL	QTY
5	SILICON GASKATE	JB-02GSK-04	SILICON	1
4	JB EXTERNAL EARTHING SET	-	AISI 304	1
3	LID MOUNTING SCREW	MM JB-SCR-LD-00	AISI 304	4
2	JB-EARTHING SCREW	-	MS COPPER PLATED	2
1	JUNCTION BOX Ex-150 x 64 x 34	Ex-1506434	AISI 12	1

B.O.M.

QUANTITY 1	MATERIAL :- <b>AISI12 DIN230</b>	MACH.NAME -	DATE 17/02/14	SIGN RRPL	NAME DESIGN
TOLERANCE ±0.2	FINISH: NATURAL	TITLE :- JUNCTION BOX 150 x 64 x 34	DATE 17/02/14	SIGN G.K.	NAME CHECKED
±0.2	ALL DIMENSION ARE IN MM	<b>Raychem RPG (P) Limited</b> Ceat Mahal Annexe, Dr. Annie Besant Road, Worli, Mumbai 400030 Web : <a href="http://www.raychemrpg.com">www.raychemrpg.com</a>	DATE 17/02/14	SIGN J.B.	NAME APPROVED
±1.0°	ANGLES	RJ 10	SCALE	PARTNO. 0	DRG. NO. Ex-AJB-1506434

PROPERTY OF RaychemRPG (P) LTD.  
ALL RIGHTS RESERVED AND/OR PHOTOCOPYING THIS DOCUMENT  
TO A PERSON WITHOUT RaychemRPG (P)LTD. WRITTEN AUTHORIZATION IS PROHIBITED