

Push Pull Connector IP67 Metal

multicomp^{PRO}

RoHS
Compliant



Diagram

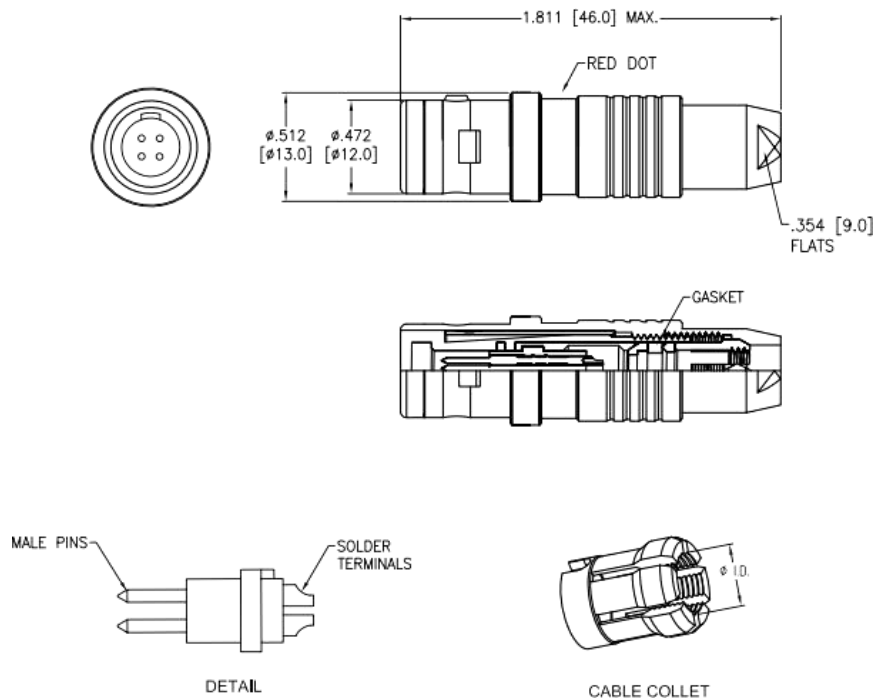

Dimensions : Millimetres

Specifications

Material

Housing (Body)	: Brass, Natural Chrome plated
Insulator	: PPS
Terminal	: Brass, Gold Plated

Electrical

Voltage Rating	: 250V
Current Rating	: See chart
Dielectric withstanding voltage	: See chart
Electrical Life	: 5,000 Cycles min.

Temperature Rating

Operating temperature	: -55°C to +150°C
-----------------------	-------------------

Environmental











IP67 Protection (Mated Condition)

Newark.com/multicomp-pro
Farnell.com/multicomp-pro
sg.element14.com/b/multicomp-pro

multicomp^{PRO}

Push Pull Connector IP67 Metal

multicomp PRO

	2 Pin	3 Pin	4 Pin	5 Pin	6 Pin	7 Pin	8 Pin	10 Pin	14 Pin	16 Pin
Configuration										
Diameter of Pin	Ø1.3	Ø1.3	Ø0.9	Ø0.9	Ø0.7	Ø0.7	Ø0.7	Ø0.5	Ø0.5	Ø0.5
Testing Voltage	1300V	1300V	1200V	1200V	1000V	1000V	1000V	800V	800V	800V
Working Voltage	300V	300V	250V	250V	200V	200V	200V	200V	200V	200V
Rated Current / Pin	9A	9A	8A	7A	5A	5A	5A	2A	2A	2A

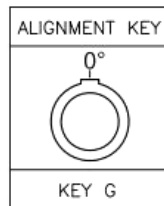
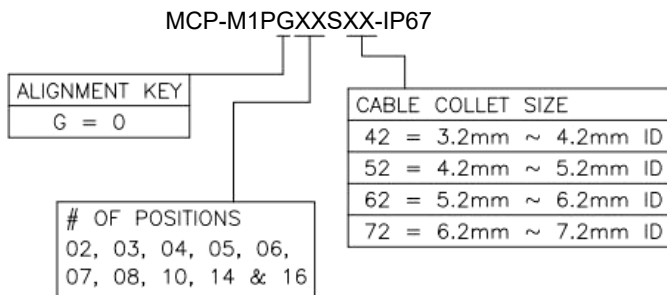

Part Number Table

Description	Position	Part Number
Push Pull Connector Male Plug, 4.2mm to 5.2mm, IP67	2	MCP-M1PG02S52-IP67
	3	MCP-M1PG03S52-IP67
	4	MCP-M1PG04S52-IP67
	5	MCP-M1PG05S52-IP67
	6	MCP-M1PG06S52-IP67
	7	MCP-M1PG07S52-IP67
	10	MCP-M1PG10S52-IP67

Important Notice : This data sheet and its contents (the "Information") belong to the members of the AVNET group of companies (the "Group") or are licensed to it. No licence is granted for the use of it other than for information purposes in connection with the products to which it relates. No licence of any intellectual property rights is granted. The Information is subject to change without notice and replaces all data sheets previously supplied. The Information supplied is believed to be accurate but the Group assumes no responsibility for its accuracy or completeness, any error in or omission from it or for any use made of it. Users of this data sheet should check for themselves the Information and the suitability of the products for their purpose and not make any assumptions based on information included or omitted. Liability for loss or damage resulting from any reliance on the Information or use of it (including liability resulting from negligence or where the Group was aware of the possibility of such loss or damage arising) is excluded. This will not operate to limit or restrict the Group's liability for death or personal injury resulting from its negligence. Multicomp Pro is the registered trademark of Premier Farnell Limited 2019.

Newark.com/multicomp-pro
Farnell.com/multicomp-pro
sg.element14.com/b/multicomp-pro

multicomp PRO