

## FEATURES

- Nylon Polyamide 6
- Zinc plated steel studs and alloy female threads
- Matte black finish
- Melting point of +215°C
- Tolerant of weak acids, with excellent resistance to chlorinated hydrocarbons
- Working temperature range of -30°C to +85°C

## RS PRO Black Multiple Lobes Clamping Knob, M5

RS Stock No.: 161-133



RS Professionally Approved Products bring to you professional quality parts across all product categories. Our product range has been tested by engineers and provides a comparable quality to the leading brands without paying a premium price.

## Product Description

Knobs are used in a wide variety of applications in our day-to-day lives and perform many functions, from being used as fixed handles to being used to tighten, loosen, adjust and push other components or pieces of equipment. They are used in various applications, from industrial and construction machinery to audio and visual equipment.

Female knobs: M5 (RS [161076](#)), M6 (RS [161082](#)), M6 (RS [161098](#)), M6 (RS [161105](#)), M8 (RS [161111](#)), M10 (RS [161127](#)).

Male knobs: M5 (RS [161133](#)), M6 (RS [161149](#)), M6 (RS [161155](#)), M8 (RS [161161](#)), M6 (RS [161177](#)), M8 (RS [161183](#)), M8 (RS [161199](#)), M10 (RS [161206](#)).

Through-threaded knobs: M6 (RS [161212](#)), M6 (RS [161228](#)), M8 (RS [161234](#)), M10 (RS [161240](#)).

## General Specifications

<b>Thread</b>	M5
<b>Knob Shape</b>	Multiple Lobes
<b>Mounting Type</b>	Threaded stud
<b>Body Material</b>	High impact resistant thermoplastic
<b>Insert Material</b>	steel
<b>Colour</b>	Black
<b>Finish</b>	Matt
<b>Application</b>	Tripods, Machinery, Audio equipment

## Mechanical Specifications

<b>Thread Diameter</b>	5mm
<b>Thread Length</b>	20mm
<b>Knob Diameter</b>	28mm
<b>Hole Diameter</b>	11mm
<b>Hole Length</b>	6mm

## Approvals

<b>Compliance/Certifications</b>	EN 61340
----------------------------------	----------

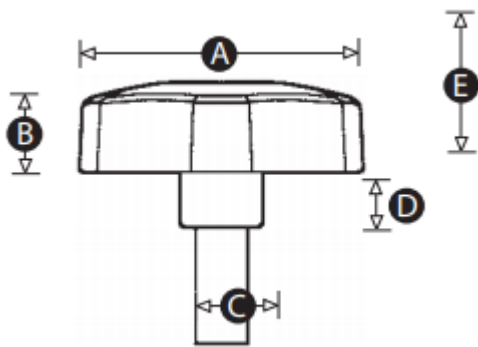

Part No.	A	B	C	D	E	Thread size	Thread length (mm)
161133	28	11	11	6	17	M5	20
161149	28	11	11	6	17	M6	20
161155	40	12	15	8	20	M6	25
161161	40	12	15	8	20	M8	35
161177	50	15	15	9	24	M6	35
161183	50	24	15	9	15	M8	40
161199	60	18	19	12	30	M8	30
161206	60	18	19	12	30	M10	40