

Energy meters

iEM3100 / iEM3200 / iEM3300 series

User manual

DOCA0005EN-14

08/2023

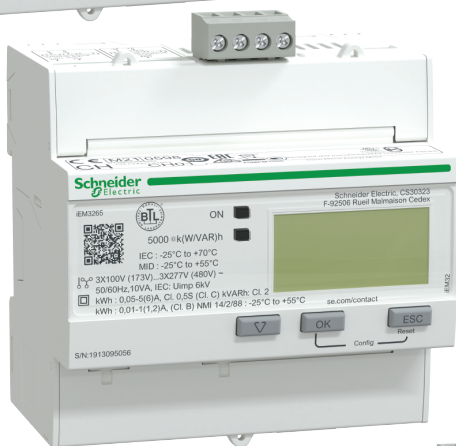
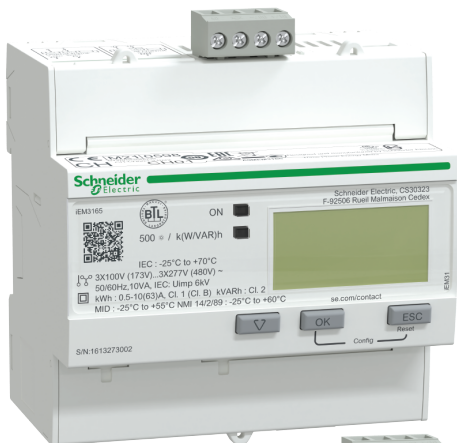

Legal Information

The Schneider Electric brand and any trademarks of Schneider Electric SE and its subsidiaries referred to in this guide are the property of Schneider Electric SE or its subsidiaries. All other brands may be trademarks of their respective owners.

This guide and its content are protected under applicable copyright laws and furnished for informational use only. No part of this guide may be reproduced or transmitted in any form or by any means (electronic, mechanical, photocopying, recording, or otherwise), for any purpose, without the prior written permission of Schneider Electric.

Schneider Electric does not grant any right or license for commercial use of the guide or its content, except for a non-exclusive and personal license to consult it on an "as is" basis. Schneider Electric products and equipment should be installed, operated, serviced, and maintained only by qualified personnel.

As standards, specifications, and designs change from time to time, information contained in this guide may be subject to change without notice.

To the extent permitted by applicable law, no responsibility or liability is assumed by Schneider Electric and its subsidiaries for any errors or omissions in the informational content of this material or consequences arising out of or resulting from the use of the information contained herein.

Safety information

Important information

Read these instructions carefully and look at the equipment to become familiar with the device before trying to install, operate, service, or maintain it. The following special messages may appear throughout this manual or on the equipment to warn of potential hazards or to call attention to information that clarifies or simplifies a procedure.



The addition of either symbol to a “Danger” or “Warning” safety label indicates that an electrical hazard exists which will result in personal injury if the instructions are not followed.



This is the safety alert symbol. It is used to alert you to potential personal injury hazards. Obey all safety messages that accompany this symbol to avoid possible injury or death.

DANGER

DANGER indicates a hazardous situation which, if not avoided, **will result in** death or serious injury.

Failure to follow these instructions will result in death or serious injury.

WARNING

WARNING indicates a hazardous situation which, if not avoided, **could result in** death or serious injury.

CAUTION

CAUTION indicates a hazardous situation which, if not avoided, **could result in** minor or moderate injury.

NOTICE

NOTICE is used to address practices not related to physical injury.

Please note

Electrical equipment should be installed, operated, serviced and maintained in restricted access locations only by qualified personnel. No responsibility is assumed by Schneider Electric for any consequences arising out of the use of this equipment. A qualified person is one who has skills and knowledge related to the construction, installation, and operation of electrical equipment and has received safety training to recognize and avoid the hazards involved.

Notices

FCC

This equipment has been tested and found to comply with the limits for a Class B digital device, pursuant to part 15 of the FCC rules. These limits are designed to provide reasonable protection against harmful interference in a residential installation. This equipment generates, uses, and can radiate radio frequency energy and, if not installed and used in accordance with the instructions, may cause harmful interference to radio communications. However, there is no guarantee that the interference will not occur in a particular installation. If this equipment does cause harmful interference to radio or television reception, which can be determined by turning the equipment off and on, the user is encouraged to try to correct the interference by one or more of the following measures:

- Reorient or relocate the receiving antenna.
- Increase the separation between the equipment and receiver.
- Connect the equipment to an outlet on a circuit different from that to which the receiver is connected.
- Consult the dealer or an experienced radio/TV technician for help.

The user is cautioned that any changes or modifications not expressly approved by Schneider Electric could void the user's authority to operate the equipment.

This digital apparatus complies with CAN ICES-3 (B) /NMB-3(B).

About this manual

This manual discusses features of the iEM3100 / iEM3200 / iEM3300 series energy meters and is intended for use by designers, system builders and maintenance technicians with an understanding of electrical distribution systems and monitoring devices.

Document scope

Throughout the manual, the term “meter / device” refers to all models of the iEM3100 / iEM3200 / iEM3300 series. All differences between the models, such as a feature specific to one model, are indicated with the appropriate model number or description.

This manual does not provide configuration information for advanced features where an expert user would perform advanced configuration. It also does not include instructions on how to incorporate meter data or perform meter configuration using energy management systems or software, other than ION Setup. ION Setup is a free configuration tool available for download from www.se.com.

Related documents

| Document | Number |
|---|---------------------|
| iEM3100 / iEM3150 instruction sheet | NHA15785 / NHA20207 |
| iEM3110 / iEM3115 / iEM3135 / iEM3155 / iEM3165 / iEM3175 instruction sheet | NHA15789 / NHA20208 |
| iEM3200 / iEM3250 instruction sheet | NHA15795 / NHA20211 |
| iEM3210 / iEM3215 / iEM3235 / iEM3255 / iEM3265 / iEM3275 instruction sheet | NHA15801 / NHA20213 |
| iEM3300 / iEM3350 instruction sheet | HRB91204 / HRB91205 |
| iEM3310 / iEM3335 / iEM3355 / iEM3365 / iEM3375 instruction sheet | HRB91202 / HRB91203 |

You can download these technical publications and other technical information from www.se.com.

Table of Contents

| | |
|---|----|
| Safety precautions | 11 |
| Meter overview | 13 |
| Overview of meter functions | 13 |
| Main characteristics | 13 |
| iEM3100 series: 63 A meters | 13 |
| iEM3300 series: 125 A meters | 14 |
| iEM3200 series: 1 A / 5 A meters | 14 |
| Functions | 15 |
| iEM3100 and iEM3300 series | 15 |
| iEM3200 series | 15 |
| Typical applications | 15 |
| Hardware and installation | 18 |
| Safety precautions | 18 |
| Dimensions | 18 |
| Meter description | 20 |
| Meter overview: iEM3100 series | 20 |
| Meter overview: iEM3200 series | 22 |
| Meter overview: iEM3300 series | 24 |
| Wiring | 26 |
| Power system wiring: iEM3100 / iEM3300 series | 26 |
| Power system wiring: iEM3200 series | 27 |
| Input, output and communications wiring considerations | 28 |
| Digital input | 29 |
| Digital output | 29 |
| Modbus / BACnet RS-485 wiring: iEM3150 / iEM3155 / iEM3165 / iEM3250 / iEM3255 / iEM3265 / iEM3350 / iEM3355 / iEM3365 | 30 |
| LonWorks / M-Bus wiring: iEM3135 / iEM3175 / iEM3235 / iEM3275 / iEM3335 / iEM3375 | 30 |
| Meter sealing points | 30 |
| Dismounting the meter from a DIN rail | 31 |
| Considerations for iEM3100 series and iEM3300 series devices associated with a contactor | 31 |
| Front panel display and meter setup | 32 |
| Overview | 32 |
| Data display | 32 |
| Data display screen overview | 32 |
| Example: navigating the display screens | 32 |
| Meter status information | 33 |
| Backlight and error / alert icon | 33 |
| Data display screens | 33 |
| Resets | 35 |
| Resetting accumulated energy using the display | 35 |
| Multi Tariff feature | 36 |
| Meter information | 36 |
| The device clock | 36 |
| Date/time format | 37 |
| Setting the clock initially | 37 |

| | |
|---|-----------|
| Device configuration | 37 |
| Entering configuration mode | 38 |
| The front panel display in configuration mode | 38 |
| Com. Protection setting | 38 |
| Modifying parameters | 39 |
| Selecting a value from a list | 39 |
| Modifying a numerical value | 39 |
| Cancelling an entry | 40 |
| Configuration mode menus | 40 |
| Configuration menu for iEM3100 / iEM3110 / iEM3115 / iEM3300 / iEM3310 | 41 |
| Configuration menu for iEM3150 / iEM3350 | 42 |
| Configuration menu for iEM3135 / iEM3155 / iEM3165 / iEM3175 / iEM3335 / iEM3355 / iEM3365 / iEM3375 | 44 |
| Configuration menu for iEM3200 / iEM3210 / iEM3215 | 46 |
| Configuration menu for iEM3250 | 48 |
| Configuration menu for iEM3235 / iEM3255 / iEM3265 / iEM3275 | 50 |
| Communications via Modbus | 53 |
| Modbus communication overview | 53 |
| Modbus communications settings | 53 |
| Communications LED indicator for Modbus devices | 53 |
| Modbus functions | 53 |
| Function list | 53 |
| Table format | 54 |
| Command interface | 55 |
| Command interface overview | 55 |
| Command request | 55 |
| Command list | 56 |
| Modbus register list | 60 |
| System | 60 |
| Meter Setup and Status | 60 |
| Energy Pulse Output Setup (iEM3155 / iEM3255 / iEM3355) | 61 |
| Command Interface | 61 |
| Communication | 62 |
| Input Metering Setup (iEM3155 / iEM3255 / iEM3355) | 62 |
| Digital Input (iEM3155 / iEM3255 / iEM3355) | 63 |
| Digital Output (iEM3155 / iEM3255 / iEM3355) | 63 |
| PF firmware updates (iEM3155 / iEM3255 / iEM3355) | 63 |
| 1PH4W Multi LN updates (iEM3155 / iEM3255 / iEM3355) | 63 |
| Meter Data | 64 |
| Overload Alarm (iEM3155 / iEM3255 / iEM3355) | 67 |
| Read Device Identification | 67 |
| Communications via LonWorks | 69 |
| LonWorks communications overview | 69 |
| LonWorks communication implementation | 69 |
| External interface file (XIF) | 69 |
| The LonMaker plug-ins | 69 |
| LED indicators for LonWorks meters | 69 |
| Location of the service pin and Neuron ID | 70 |

| | |
|---|------------|
| Standard network variable types and configuration properties for reading data | 70 |
| Meter configuration properties | 74 |
| Echelon LonMaker plug-in for data display and meter configuration..... | 78 |
| Communications via M-Bus..... | 80 |
| M-Bus communications overview..... | 80 |
| Configuring basic communications settings..... | 80 |
| Key terms..... | 80 |
| M-Bus protocol support..... | 81 |
| M-Bus protocol implementation..... | 81 |
| M-Bus tool for viewing data and configuring the meter | 81 |
| Communications LED indicator for M-Bus meters | 81 |
| Variable data structure telegram information | 82 |
| Fixed data header..... | 82 |
| Decoding secondary address and M-Bus serial number..... | 82 |
| Data record header information..... | 83 |
| Telegram information for data records | 85 |
| Meter information..... | 85 |
| Energy and energy by tariff measurements (INT64 and FLOAT32) | 86 |
| Instantaneous measurements..... | 87 |
| Meter status information | 87 |
| Telegram decode information (all values are in hexadecimal) | 90 |
| Telegram information for meter configuration | 101 |
| Supported VIFE codes for meter configuration | 101 |
| Date/time setup | 101 |
| Power system setup..... | 101 |
| Multi Tariff setup..... | 102 |
| Communications setup..... | 102 |
| Digital input setup | 103 |
| Digital output setup | 103 |
| Overload alarm setup and acknowledgment..... | 103 |
| Resets | 104 |
| M-Bus tool for data display and meter configuration..... | 104 |
| Installing the M-Bus tool | 104 |
| Accessing the meter using the tool | 105 |
| Viewing meter data using the M-Bus tool | 106 |
| Configuring the meter using the M-Bus tool..... | 107 |
| Communications via BACnet | 109 |
| BACnet communications overview | 109 |
| BACnet protocol support | 109 |
| BACnet communications implementation | 110 |
| Configuring basic communication parameters | 110 |
| Communications LED indicator for BACnet meters | 111 |
| Change of Value (COV) subscriptions..... | 111 |
| BACnet object and property information | 111 |
| Device object..... | 111 |
| Analog Input objects..... | 113 |
| Analog value object..... | 116 |
| Binary input objects..... | 116 |

| | |
|--|-----|
| Power, energy and power factor | 118 |
| Power (PQS)..... | 118 |
| Power and the PQ coordinate system | 118 |
| Power flow | 118 |
| Energy delivered (imported) / energy received (exported) | 118 |
| Power factor (PF) | 119 |
| PF lead / lag convention | 119 |
| PF sign convention | 120 |
| Power factor register format | 121 |
| Troubleshooting | 123 |
| Overview | 123 |
| Diagnosis screen..... | 123 |
| Diagnostic codes | 123 |
| Specifications | 125 |
| Electrical characteristics..... | 125 |
| Power system inputs: iEM3100 series | 125 |
| Power system inputs: iEM3300 series | 125 |
| Power system inputs: iEM3200 series | 126 |
| Inputs and outputs | 126 |
| Mechanical characteristics | 127 |
| Environmental characteristics | 128 |
| Safety, EMI/EMC and product standards | 128 |
| Measurement accuracy..... | 128 |
| MID/MIR | 129 |
| Internal clock..... | 129 |
| Modbus communications..... | 129 |
| LonWorks communications | 130 |
| M-Bus communications..... | 130 |
| BACnet communications | 130 |
| China Standard Compliance | 131 |

Safety precautions

Installation, wiring, testing and service must be performed in accordance with all local and national electrical codes.

| |
|---|
|  DANGER |
| <p>HAZARD OF ELECTRIC SHOCK, EXPLOSION, OR ARC FLASH</p> <ul style="list-style-type: none"> • Apply appropriate Personal Protective Equipment (PPE) and follow safe electrical work practices. See NFPA 70E, CSA Z462 or other local standards. • Turn off all power supplying this device and the equipment in which it is installed before working on or in the equipment. • Always use a properly rated voltage sensing device to confirm that all power is off. • Assume communications and I/O wiring are hazardous live until determined otherwise. • Do not exceed the maximum ratings of this device. • Do not short secondary terminals of Voltage Transformer (VT). • Do not open secondary terminals of Current Transformer (CT). • Ground secondary circuit of CTs. • Do not use the data from the meter to confirm power is off. • Replace all devices, doors and covers before turning on power to this equipment. • Do not install CTs or LPCTs in equipment where they exceed 75% of the wiring space of any cross-sectional area in the equipment. • Do not install CTs or LPCTs in areas where ventilation openings may be blocked or in areas of breaker arc venting. • Secure CT or LPCT secondary conductors to ensure they do not contact live circuits. • Do not use water or any liquid material to clean the product. Use a cleaning cloth to remove dirt. If dirt cannot be removed, contact local Technical Support representative. • The installer is responsible for co-ordinating the rating and the characteristics of the supply side over current protection devices with the maximum current rating. <p>Failure to follow these instructions will result in death or serious injury.</p> |

NOTE: See IEC 60950-1, Annex W for more information on communications and I/O wiring connected to multiple devices.

| |
|--|
|  WARNING |
| <p>UNINTENDED OPERATION</p> <p>Do not use this device for critical control or protection of persons, animals, property or equipment.</p> <p>Failure to follow these instructions can result in death, serious injury, or equipment damage.</p> |

⚠ WARNING**INACCURATE DATA RESULTS**

- Do not rely solely on data displayed on the display or in software to determine if this device is functioning correctly or complying with all applicable standards.
- Do not use data displayed on the display or in software as a substitute for proper workplace practices or equipment maintenance.

Failure to follow these instructions can result in death, serious injury, or equipment damage.

Meter overview

Overview of meter functions

The meters provide the essential measurement capabilities (for example, current, voltage, and energy) required to monitor a 1-phase or 3-phase electrical installation.

The key features of the meters are:

- Measurement of active and reactive energy
- Multi Tariffs (up to 4) controlled by internal clock, digital inputs or communication
- MID/MIR compliance for many of the meters
- Pulse outputs
- Display (current, voltage, and energy measurements)
- Communications via Modbus, LonWorks, M-Bus or BACnet protocols

Main characteristics

iEM3100 series: 63 A meters

| Function | | iEM3100 | iEM3110 | iEM3115 | iEM3135 | iEM3150 | iEM3155 | iEM3165 | iEM3175 |
|--|--|---------|---------|---------|---------|---------|---------|---------|---------|
| Direct measurement (up to 63 A) | | √ | √ | √ | √ | √ | √ | √ | √ |
| Active Energy measurement accuracy class (total and partial kWh) | | 1 | 1 | 1 | 1 | 1 | 1 | 1 | 1 |
| Four Quadrant Energy measurements | | — | — | — | √ | — | √ | √ | √ |
| Electrical measurements (I, V, P, ...) | | — | — | — | √ | √ | √ | √ | √ |
| Multi Tariff | Controlled by internal clock | — | — | 4 | 4 | — | 4 | 4 | 4 |
| | Controlled by digital input(s) | — | — | 4 | 2 | — | 2 | 2 | 2 |
| | Controlled by communications | — | — | — | 4 | — | 4 | 4 | 4 |
| Measurement display (number of lines) | | 3 | 3 | 3 | 3 | 3 | 3 | 3 | 3 |
| Digital inputs | Programmable (status, tariff control, or input monitoring) | — | — | — | 1 | — | 1 | 1 | 1 |
| | Tariff control only | — | — | 2 | — | — | — | — | — |
| Digital outputs | Programmable (energy pulsing or overload alarm) | — | — | — | 1 | — | 1 | 1 | — |
| | Pulse output only | — | 1 | — | — | — | — | — | — |
| Overload alarm | | — | — | — | √ | — | √ | √ | √ |
| Communications | Modbus | — | — | — | — | √ | √ | — | — |
| | LonWorks | — | — | — | — | — | — | — | √ |
| | M-Bus | — | — | — | √ | — | — | — | — |
| | BACnet | — | — | — | — | — | — | √ | — |
| MID/MIR compliant | | — | √ | √ | √ | — | √ | √ | √ |
| Width (18 mm module in DIN rail mounting) | | 5 | 5 | 5 | 5 | 5 | 5 | 5 | 5 |

iEM3300 series: 125 A meters

| Function | | iEM3300 | iEM3310 | iEM3335 | iEM3350 | iEM3355 | iEM3365 | iEM3375 |
|---|---|---------|---------|---------|---------|---------|---------|---------|
| Direct measurement (up to 125 A) | | √ | √ | √ | √ | √ | √ | √ |
| Active Energy measurement accuracy class (total and partial kWh) | | 1 | 1 | 1 | 1 | 1 | 1 | 1 |
| Four Quadrant Energy measurements | | — | — | √ | — | √ | √ | √ |
| Electrical measurements (I, V, P, ...) | | — | — | √ | √ | √ | √ | √ |
| Multi Tariff | Controlled by internal clock | — | — | 4 | — | 4 | 4 | 4 |
| | Controlled by digital input(s) | — | — | 2 | — | 2 | 2 | 2 |
| | Controlled by communications | — | — | 4 | — | 4 | 4 | 4 |
| Measurement display (number of lines) | | 3 | 3 | 3 | 3 | 3 | 3 | 3 |
| Digital inputs (programmable for status, tariff control, or input monitoring) | | — | — | 1 | — | 1 | 1 | 1 |
| Digital outputs | Programmable (energy pulsing or overload alarm) | — | — | 1 | — | 1 | 1 | — |
| | Pulse output only | — | 1 | — | — | — | — | — |
| Overload alarm | | — | — | √ | — | √ | √ | √ |
| Communications | Modbus | — | — | — | √ | √ | — | — |
| | LonWorks | — | — | — | — | — | — | √ |
| | M-Bus | — | — | √ | — | — | — | — |
| | BACnet | — | — | — | — | — | √ | — |
| MID/MIR compliant | | — | √ | √ | — | √ | √ | √ |
| Width (18 mm module in DIN rail mounting) | | 7 | 7 | 7 | 7 | 7 | 7 | 7 |

iEM3200 series: 1 A / 5 A meters

| Function | | iEM3200 | iEM3210 | iEM3215 | iEM3235 | iEM3250 | iEM3255 | iEM3265 | iEM3275 |
|---|--|---------|---------|---------|---------|---------|---------|---------|---------|
| Measurement inputs through CTs (1 A, 5 A) | | √ | √ | √ | √ | √ | √ | √ | √ |
| Measurement inputs through VTs | | — | — | — | √ | √ | √ | √ | √ |
| 1 A: Active Energy measurement accuracy class (total and partial kWh) | | 1 | 1 | 1 | 1 | 1 | 1 | 1 | 1 |
| 5 A: Active Energy measurement accuracy class (total and partial kWh) | | 0.5S | 0.5S | 0.5S | 0.5S | 0.5S | 0.5S | 0.5S | 0.5S |
| Four Quadrant Energy measurements | | — | — | — | √ | — | √ | √ | √ |
| Electrical measurements (I, V, P, ...) | | — | — | — | √ | √ | √ | √ | √ |
| Multi Tariff | Controlled by internal clock | — | — | 4 | 4 | — | 4 | 4 | 4 |
| | Controlled by digital input(s) | — | — | 4 | 2 | — | 2 | 2 | 2 |
| | Controlled by communications | — | — | — | 4 | — | 4 | 4 | 4 |
| Measurement display (number of lines) | | 3 | 3 | 3 | 3 | 3 | 3 | 3 | 3 |
| Digital inputs | Programmable (status, tariff control, or input monitoring) | — | — | — | 1 | — | 1 | 1 | 1 |
| | Tariff control only | — | — | 2 | — | — | — | — | — |

| Function | | iEM3200 | iEM3210 | iEM3215 | iEM3235 | iEM3250 | iEM3255 | iEM3265 | iEM3275 |
|---|---|---------|---------|---------|---------|---------|---------|---------|---------|
| Digital outputs | Programmable (energy pulsing or overload alarm) | — | — | — | 1 | — | 1 | 1 | — |
| | Pulse output only | — | 1 | — | — | — | — | — | — |
| Overload alarm | | — | — | — | √ | — | √ | √ | √ |
| Communications | Modbus | — | — | — | — | √ | √ | — | — |
| | LonWorks | — | — | — | — | — | — | — | √ |
| | M-Bus | — | — | — | √ | — | — | — | — |
| | BACnet | — | — | — | — | — | — | √ | — |
| MID/MIR compliant | | — | √ | √ | √ | — | √ | √ | √ |
| Width (18 mm module in DIN rail mounting) | | 5 | 5 | 5 | 5 | 5 | 5 | 5 | 5 |

Functions

These meters can monitor energy consumption by usage, by zone or by feeder in the cabinet. They can be used to monitor feeders in a main switchboard or to monitor the main in a distribution cabinet.

iEM3100 and iEM3300 series

| Functions | Advantages |
|---|---|
| Can directly measure feeders up to: iEM3100 series: 63 A iEM3300 series: 125 A Embedded current transformers (CTs) | Saves installation time and space in the cabinet No wiring to manage Clear distribution network |
| Adapted to be installed with Acti9 iC60 (iEM3100 series) or Acti9 C120, NG125 (iEM3300 series) circuit breakers | Can be used in three-phase systems with or without neutral |
| Can be used for single-phase multi-circuit monitoring | 3 single feeders can be monitored with a single meter |

iEM3200 series

| Functions | Advantages |
|------------------------|--|
| CT and VT connection | Can be used in low or medium voltage applications |
| Flexible configuration | Can be adapted to any distribution network with or without neutral |

Typical applications

The following table presents some of the functions of the different meters, the advantages and main applications.

| Functions | Advantages | Applications | Meter |
|---|---|--|---|
| Total and partial energy counters | Energy usage monitoring | Sub-billing management Metering applications | iEM3100 / iEM3200 / iEM3300 series |
| Internal clock | Saves the date and time of last reset | Provides the timestamp of the last reset of the partial energy accumulation | All (except iEM3100 / iEM3200 / iEM3300) |
| Pulse output with a configurable pulse weight of up to 1 pulse per 1 Wh | Collect pulses from the meter with a Smartlink system, PLC or any basic acquisition system | Remote monitoring of energy consumption Integrate the meter in to a system monitoring of a large number of devices | iEM3110 / iEM3210 / iEM3310 |
| Manages up to four tariffs, controlled by the digital input(s), internal clock or communications (depending on meter model) | Categorize energy consumption into On Peak and Off Peak, working days and weekends, or by different electricity sources (for example, from the utility and an electrical generator) | Energy demand management Sub-billing management Identification of local energy consumption behavior by zone, by usage or by feeder | iEM3115 / iEM3135 / iEM3155 / iEM3165 / iEM3175 / iEM3215 / iEM3235 / iEM3255 / iEM3265 / iEM3275 / iEM3335 / iEM3355 / iEM3365 / iEM3375 |
| Measures essential electrical parameters like current, average voltage and total power | Instantaneous measurements help you monitor the imbalance between phases Total power allows you to monitor the feeder load level | Monitoring of feeders or any sub-cabinet | iEM3100 / iEM3200 / iEM3300 series |
| M-Bus communications | Communicate advanced parameters using M-Bus protocol | M-Bus network integration | iEM3135 / iEM3235 / iEM3335 |
| Modbus communications | Communicate advanced parameters using Modbus protocol | Modbus network integration | iEM3150 / iEM3155 / iEM3250 / iEM3255 / iEM3350 / iEM3355 |
| BACnet communications | Communicate advanced parameters using BACnet MS/TP protocol | BACnet network integration | iEM3165 / iEM3265 / iEM3365 |
| LonWorks communications | Communicate advanced parameters using LonWorks communications | LonWorks network integration | iEM3175 / iEM3275 / iEM3375 |
| Four quadrant calculation | Identification of imported and exported active and reactive energy allows you to monitor energy flow in both directions: delivered from the utility and produced on-site | Ideal for facilities with back-up generators or green power capabilities (for example, solar panels or wind turbines) | iEM3135 / iEM3155 / iEM3165 / iEM3175 / iEM3235 / iEM3255 / iEM3265 / iEM3275 / iEM3335 / iEM3355 / iEM3365 / iEM3375 |
| Measurement of active energy | Allows you to monitor energy consumption and production | Manage energy consumption and make informed investment to reduce your energy bill or penalties (for example, installing capacitor banks) | iEM3100 / iEM3200 / iEM3300 series |
| Measurement of reactive energy | Allows you to monitor energy consumption and production | Manage energy consumption and make informed investment to reduce your energy bill or penalties (for example, installing capacitor banks) | iEM3135 / iEM3155 / iEM3165 / iEM3175 / iEM3235 / iEM3255 / iEM3265 / iEM3275 / iEM3335 / iEM3355 / iEM3365 / iEM3375 |

| Functions | Advantages | Applications | Meter |
|-----------------------------|---|--|--|
| Programmable digital input | Can be programmed to: <ul style="list-style-type: none"> • Count pulses from other meters (gas, water, etc.) • Monitor an external status • Reset the partial energy accumulation and start a new period of accumulation | This allows for monitoring of: <ul style="list-style-type: none"> • WAGES • Intrusion (for example, doors opening) or equipment status • Energy usage | iEM3135 / iEM3155 / iEM3165 / iEM3175 / iEM3235 / iEM3255 / iEM3265 / iEM3275 / iEM3335 / iEM3355 / iEM3365 / iEM3375 |
| Programmable digital output | Can be programmed to: <ul style="list-style-type: none"> • Be an active energy (kWh) pulse output, with a configurable pulse weight • Alarm on a power overload at a configurable pickup setpoint | This allows you to: <ul style="list-style-type: none"> • Collect pulses from the meter with a Smartlink system, PLC or any basic acquisition system • Monitor power levels at a detailed level and to help detect an overload before the circuit breaker trips | iEM3135 / iEM3155 / iEM3165 / iEM3235 / iEM3255 / iEM3265 / iEM3335 / iEM3355 / iEM3365 |

Hardware and installation

Safety precautions

Installation, wiring, testing and service must be performed in accordance with all local and national electrical codes.

⚡ ⚠ DANGER

HAZARD OF ELECTRIC SHOCK, EXPLOSION, OR ARC FLASH

- Apply appropriate Personal Protective Equipment (PPE) and follow safe electrical work practices. See NFPA 70E, CSA Z462 or other local standards.
- Turn off all power supplying this device and the equipment in which it is installed before working on or in the equipment.
- Always use a properly rated voltage sensing device to confirm that all power is off.
- Replace all devices, doors and covers before turning on power to this equipment.
- Do not exceed the maximum ratings of this device.
- Do not touch the current terminal when the meter is energized.

Failure to follow these instructions will result in death or serious injury.

Dimensions

iEM3100 series

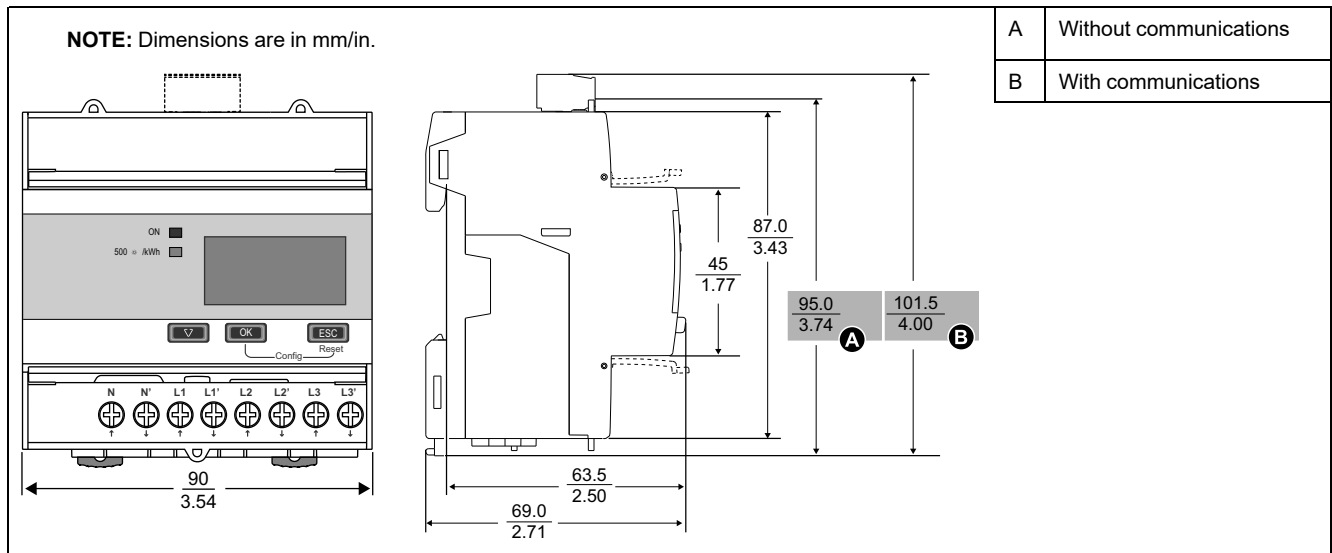

iEM3200 series

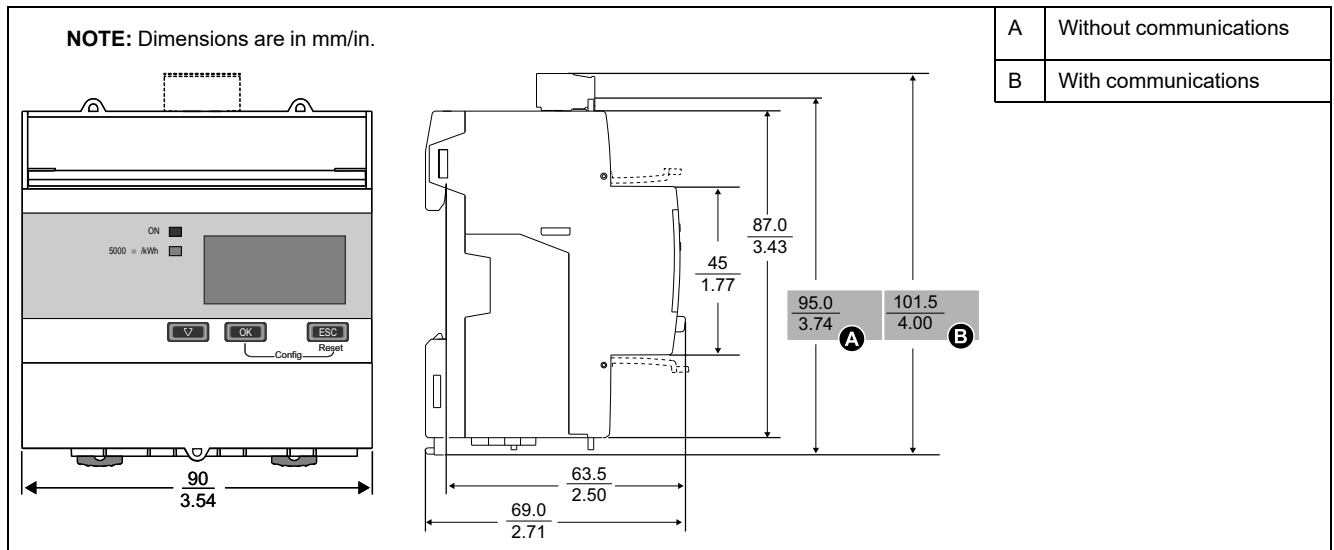

iEM3300 series

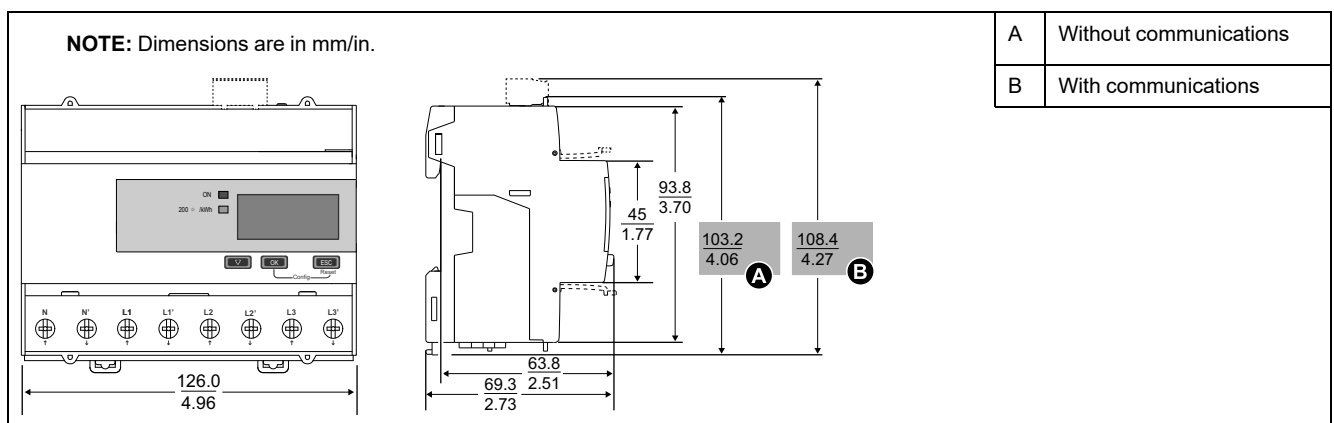

Meter description

Meter overview: iEM3100 series

| | |
|---|--|
| A | Modbus communication port (iEM3150) |
| B | Modbus communication LED (iEM3150) |
| C | Display with white backlight for measurement and configuration |
| D | Scroll through screens or a list of options |
| E | Confirm entry or access more screens |
| F | Cancel and go back to previous screen |
| G | L1, L2, L3, N |
| H | Energy pulse LED |
| I | Status LED: on / off / error |
| J | Sealing points (3) |
| K | Sealable covers (2) |

NOTE: The sealable covers must be installed and sealed to the sealing points with the steel cable. Use steel cable with 1.6 mm (1/16 in) diameter and 152.4 mm (6 in) adjustable length for sealing.

| | |
|---|--|
| A | Digital input (iEM3115 / iEM3135 / iEM3155 / iEM3165 / iEM3175) |
| B | Digital output (iEM3135 / iEM3155 / iEM3165) |
| C | M-Bus communication port (iEM3135) Modbus communication port (iEM3155 / iEM3165) LonWorks communication port (iEM3175) |
| D | M-Bus communication LED (iEM3135) Modbus communication LED (iEM3155 / iEM3165) LonWorks communication LED (iEM3175) |
| E | Display with white backlight for measurement and configuration |
| F | Scroll through screens or a list of options |
| G | Confirm entry or access more screens |
| H | Cancel and go back to previous screen |
| I | L1, L2, L3, N |
| J | Energy pulse LED |
| K | Status LED: on / off / error |
| L | LonWorks service pin (iEM3175) |
| M | Pulse output (iEM3110) |
| N | Sealing points (3) |
| O | Sealable covers (2) |

NOTE: The sealable covers must be installed and sealed to the sealing points with the steel cable. Use steel cable with 1.6 mm (1/16 in) diameter and 152.4 mm (6 in) adjustable length for sealing.

Meter overview: iEM3200 series

The diagram illustrates the iEM3250 and iEM3200 meters. The top-left view shows the iEM3250 with callouts A (Modbus port), B (Modbus LED), C (display), D (OK button), E (ESC button), F (Reset button), G (terminals), H (Energy pulse LED), and I (Status LED). The top-right view shows the iEM3250 / iEM3200 with callouts J (sealing points) and K (sealable covers). The bottom-left view shows the iEM3200 with callouts C, D, E, F, G, H, and I. The terminal block includes V1, V2, V3, Vn, (11), (12), (13) and S1, S2, S1, S2, S1, S2.

| | |
|---|--|
| A | Modbus communication port (iEM3250) |
| B | Modbus communication LED (iEM3250) |
| C | Display with white backlight for measurement and configuration |
| D | Scroll through screens or a list of options |
| E | Confirm entry or access more screens |
| F | Cancel and go back to previous screen |
| G | V1, V2, V3, Vn, I1, I2, I3 |
| H | Energy pulse LED |
| I | Status LED: on / off / error |
| J | Sealing points (3) |
| K | Sealable covers (2) |

NOTE: The sealable covers must be installed and sealed to the sealing points with the steel cable. Use steel cable with 1.6 mm (1/16 in) diameter and 152.4 mm (6 in) adjustable length for sealing.

iEM3235 / iEM3255 / iEM3265

iEM3275

iEM3215

iEM3210

iEM3210 / iEM3215 / iEM3235 / iEM3255 / iEM3265 / iEM3275

| | |
|---|--|
| A | Digital input (iEM3215 / iEM3235 / iEM3255 / iEM3265 / iEM3275) |
| B | Digital output (iEM3235 / iEM3255 / iEM3265) |
| C | M-Bus communication port (iEM3235) Modbus communication port (iEM3255 / iEM3265) LonWorks communication port (iEM3275) |
| D | M-Bus communication LED (iEM3235) Modbus communication LED (iEM3255 / iEM3265) LonWorks communication LED (iEM3275) |
| E | Display with white backlight for measurement and configuration |
| F | Scroll through screens or a list of options |
| G | Confirm entry or access more screens |
| H | Cancel and go back to previous screen |
| I | V1, V2, V3, Vn, I1, I2, I3 |
| J | Energy pulse LED |
| K | Status LED: on / off / error |
| L | LonWorks service pin (iEM3275) |
| M | Pulse output (iEM3210) |
| N | Sealing points (3) |
| O | Sealable covers (2) |

NOTE: The sealable covers must be installed and sealed to the sealing points with the steel cable. Use steel cable with 1.6 mm (1/16 in) diameter and 152.4 mm (6 in) adjustable length for sealing.

Meter overview: iEM3300 series

The diagram illustrates the hardware components of the iEM3300 series meters. It includes two front views (iEM3350 and iEM3300) and one back view (iEM3350 / iEM3300). Callouts A through K identify specific features: A (Modbus port), B (Modbus LED), C (display), D (navigation buttons), E (confirm button), F (cancel button), G (terminals), H (energy pulse LED), I (status LED), J (sealing points), and K (sealable covers).

| | |
|---|--|
| A | Modbus communication port (iEM3350) |
| B | Modbus communication LED (iEM3350) |
| C | Display with white backlight for measurement and configuration |
| D | Scroll through screens or a list of options |
| E | Confirm entry or access more screens |
| F | Cancel and go back to previous screen |
| G | L1, L2, L3, N |
| H | Energy pulse LED |
| I | Status LED: on / off / error |
| J | Sealing points (4) |
| K | Sealable covers (2) |

NOTE: The sealable covers must be installed and sealed to the sealing points with the steel cable. Use steel cable with 1.6 mm (1/16 in) diameter and 152.4 mm (6 in) adjustable length for sealing.

iEM3335 / iEM3355 / iEM3365

iEM3310

iEM3375

iEM3335 / iEM3355 / iEM3365 / iEM3375 / iEM3310

| | |
|---|--|
| A | Digital input (iEM3335 / iEM3355 / iEM3365 / iEM3375) |
| B | Digital output (iEM3335 / iEM3355 / iEM3365) |
| C | M-Bus communication port (iEM3335) Modbus communication port (iEM3355 / iEM3365) LonWorks communication port (iEM3375) |
| D | M-Bus communication LED (iEM3335) Modbus communication LED (iEM3355 / iEM3365) LonWorks communication LED (iEM3375) |
| E | Display with white backlight for measurement and configuration |
| F | Scroll through screens or a list of options |
| G | Confirm entry or access more screens |
| H | Cancel and go back to previous screen |
| I | L1, L2, L3, N |
| J | Energy pulse LED |
| K | Status LED: on / off / error |
| L | LonWorks service pin (iEM3375) |
| M | Pulse output (iEM3310) |
| N | Sealing points (4) |
| O | Sealable covers (2) |

NOTE: The sealable covers must be installed and sealed to the sealing points with the steel cable. Use steel cable with 1.6 mm (1/16 in) diameter and 152.4 mm (6 in) adjustable length for sealing.

Wiring

Power system wiring: iEM3100 / iEM3300 series

⚡⚠ DANGER

HAZARD OF ELECTRIC SHOCK, EXPLOSION, OR ARC FLASH

Do not connect N' to the load when setting the wiring type on the meter to 1PH4W Multi L-N.

Failure to follow these instructions will result in death or serious injury.

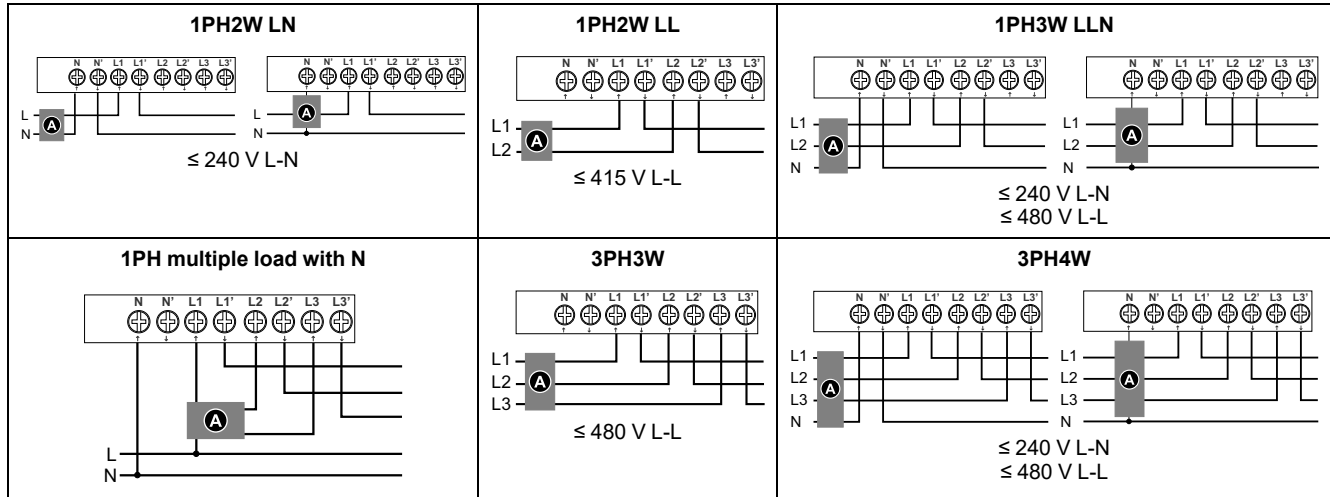

A Fuses and disconnect switch

Clearly label the device's disconnect circuit mechanism and install it within easy reach of the operator.

Fuses / circuit breakers must be:

- Installed in accordance with all local and national electrical codes and standards.
- Rated for the installation voltage, available fault current, and sized for connected loads.

Fuse for neutral is required if the source neutral is not grounded.

Power system wiring: iEM3200 series

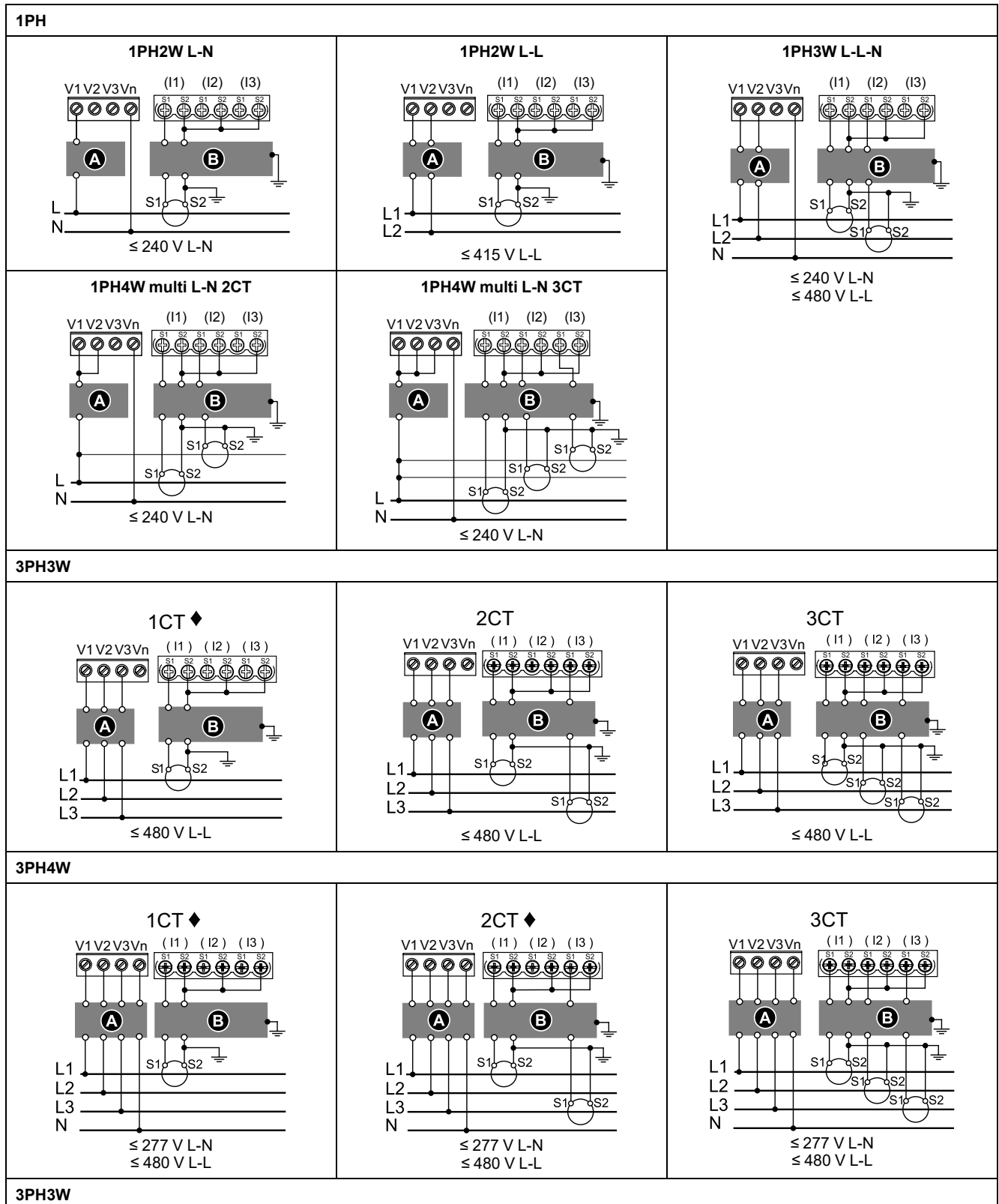

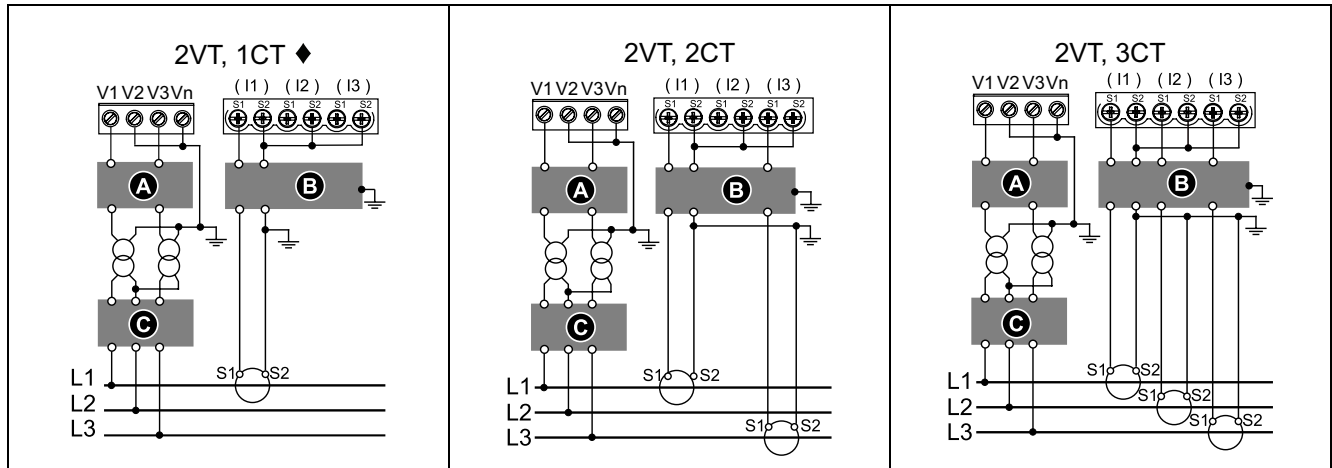

3PH4W

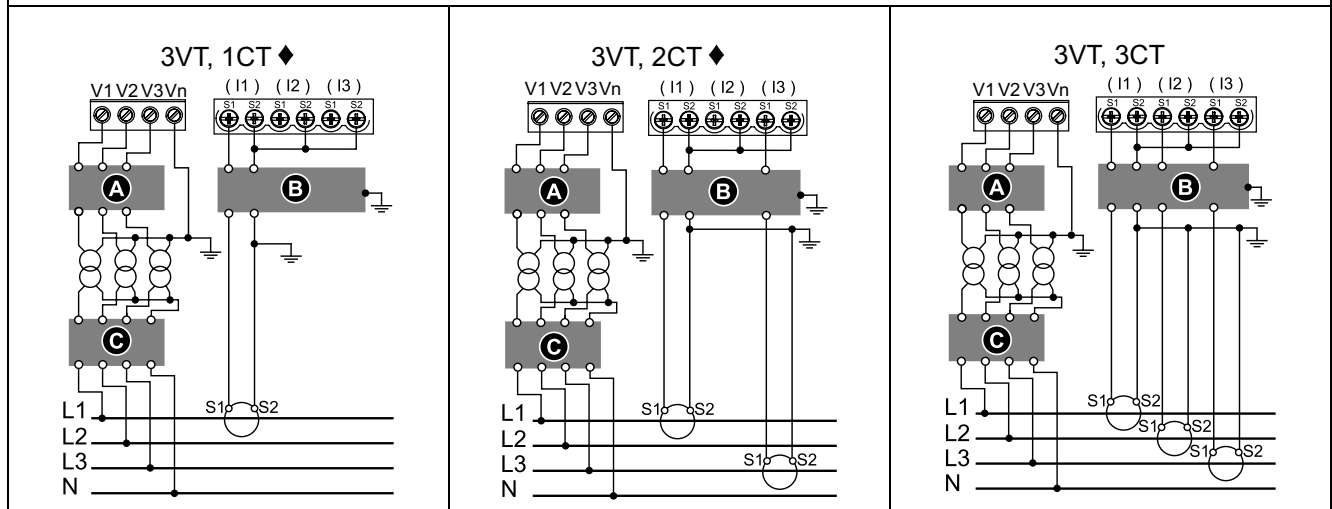

A 250 mA fuses and disconnect switch

B Shorting block

C VT primary fuses and disconnect switch

◆ indicates wiring for a balanced system

Clearly label the device's disconnect circuit mechanism and install it within easy reach of the operator.

Fuses / circuit breakers must be:

- Installed in accordance with all local and national electrical codes and standards.
- Rated for the installation voltage, available fault current, and sized for connected loads.

Fuse for neutral is required if the source neutral is not grounded.

Input, output and communications wiring considerations

The pulse output is compatible with S0 format, and the programmable digital output is compatible with S0 format when configured as a pulse output.

The digital input and output are electrically independent.

The digital output is polarity-independent.

Digital input

Programmable (status, tariff control, or input monitoring): iEM3135 / iEM3155 / iEM3165 / iEM3175 / iEM3235 / iEM3255 / iEM3265 / iEM3275 / iEM3335 / iEM3355 / iEM3365 / iEM3375

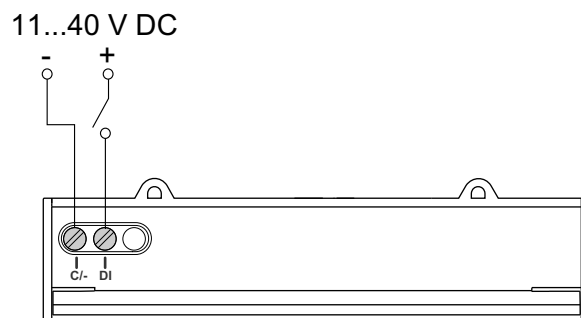

Tariff control only: iEM3115 / iEM3215

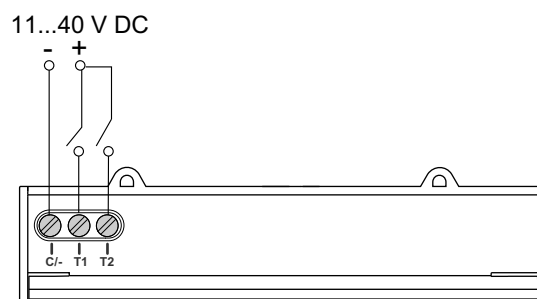

Digital output

Programmable (energy pulsing or overload alarm): iEM3135 / iEM3155 / iEM3165 / iEM3235 / iEM3255 / iEM3265 / iEM3335 / iEM3355 / iEM3365

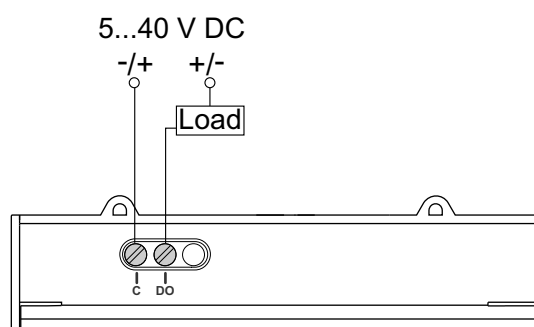

Pulse output: iEM3110 / iEM3210 / iEM3310

The pulse output indicates the primary consumption with consideration of transformer ratios.

It can be directly connected to a 24 V DC (< 30 V DC) input on a Zelio or Twido PLC.

For other concentrators, if $V_{DC} / R_{in} > 15 \text{ mA}$, add a resistor $R_{add} = (V_{DC} / 0.01) - R_{in} \Omega$

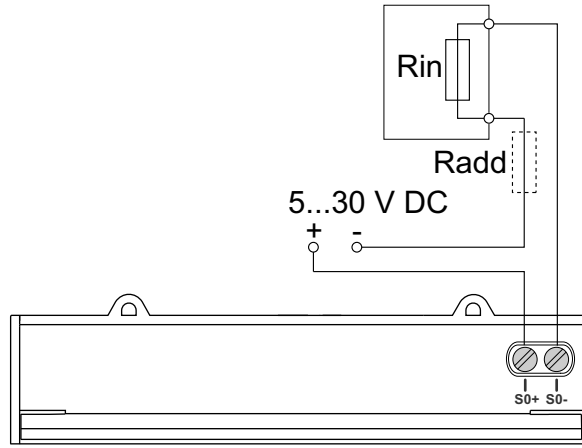

Modbus / BACnet RS-485 wiring: iEM3150 / iEM3155 / iEM3165 / iEM3250 / iEM3255 / iEM3265 / iEM3350 / iEM3355 / iEM3365

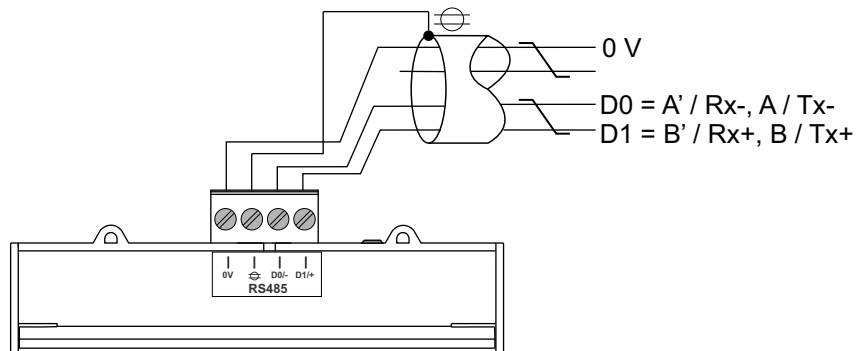

LonWorks / M-Bus wiring: iEM3135 / iEM3175 / iEM3235 / iEM3275 / iEM3335 / iEM3375

The Lon and M-Bus ports are polarity-independent.

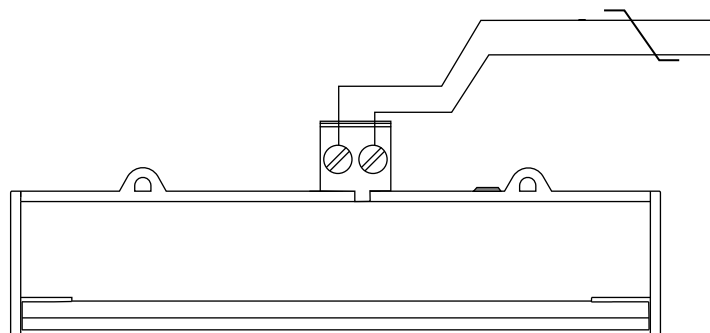

Meter sealing points

All meters have sealing covers and sealing points to help prevent access to inputs and outputs and current and voltage connections.

Dismounting the meter from a DIN rail

1. Use a flat-tip screwdriver (≤ 6.5 mm / 0.25 in) to lower the locking mechanism and release the meter.

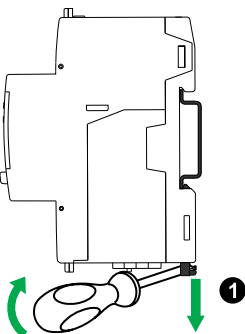

2. Lift the meter out and up to free it from the DIN rail.

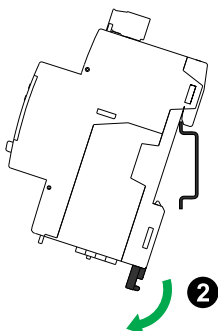

Considerations for iEM3100 series and iEM3300 series devices associated with a contactor

Connection requirements for iEM3100 / iEM3110 / iEM3115 / iEM3135 / iEM3150 / iEM3155 / iEM3165 / iEM3175 / iEM3300 / iEM3310 / iEM3335 / iEM3350 / iEM3355 / iEM3365 / iEM3375:

- When the meter is associated with a contactor, connect the meter upstream of the contactor.
- The meter must be protected by a circuit breaker.

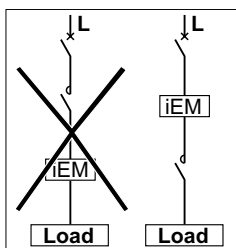

Front panel display and meter setup

Overview

The meter features a front panel with signaling LEDs, a graphical display, and menu buttons that allow you to access the information required to operate the meter and modify parameter settings.

The front panel also allows you to display, configure and reset parameters.

Some meters have the Multi Tariff feature, which allows you to configure different tariffs.

Data display

Data display screen overview

The diagram shows a screen with the following text: "Total Ea Import", "1234.5", "T1 23 Apr 2014 12:00 kWh", and a warning icon. Below the screen are three buttons: a down arrow, "OK", and "ESC".

| | |
|---|--|
| A | Measurement |
| B | Ea / Er = active / reactive energy (if available) |
| C | Value |
| D | Active tariff (if applicable) |
| E | Scroll through the available screens |
| F | View more screens related to the measurement category (if available) |
| G | Go back to previous screen |
| H | Date and time (if applicable) |
| I | Unit |
| J | Icon indicating date / time are not set |

Example: navigating the display screens

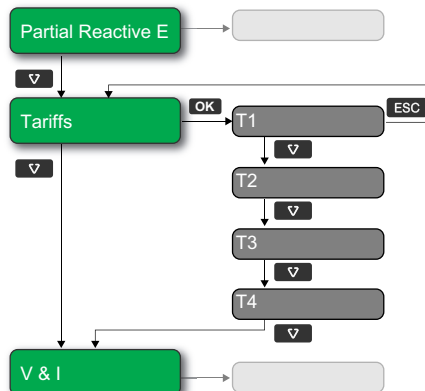















1. Press **▼** to scroll through the main display screens; then press **▼** to move from **Partial Reactive E** to **Tariffs** to **V & I**.
2. Press **OK** to access additional screens related to main screen (if available); then press **OK** to access screens for each of the available tariffs.
3. Press **▼** to scroll through these additional screens.

Meter status information

Two LEDs on the front panel indicate the current status of the device: the green status LED and the yellow energy pulsing LED.















The icons in the table below indicate the LED state:

-  = LED is off
-  = LED is on
-  = LED is flashing

| Status LED | Energy pulsing LED | Description |
|---|---|-------------------------------|
|  |  | Off |
|  |  1 s >  | On, no pulse counting |
|  |  | On, with pulse counting |
|  |  | Error, pulse counting stopped |
|  |  | Abnormal, with pulse counting |

Backlight and error / alert icon

The backlight (display screen) and error / alert icon on the top right corner of the display screen indicate the meter status.

|  Backlight |  Error / Alert icon | Description |
|---|--|--|
|  OFF | - | Device not powered ON or device is OFF |
|  ON / Dim |  OFF | LCD is in power saving mode. |
|  ON / Normal |  OFF | Normal working status. |
|  Flashing |  Flashing | Alarm / diagnosis is active. |
|  ON / Dim |  Flashing | Alarm / diagnosis is active for 3 hours and LCD is in power saving mode. |
|  ON / Normal  ON / Dim |  ON | Not active alarm. Logged alarms are not acknowledged by the user. |

Data display screens

The following sections outline the data display screens available on the various meter models.

Data display screens: iEM3100 / iEM3110 / iEM3115 / iEM3200 / iEM3210 / iEM3215 / iEM3300 / iEM3310

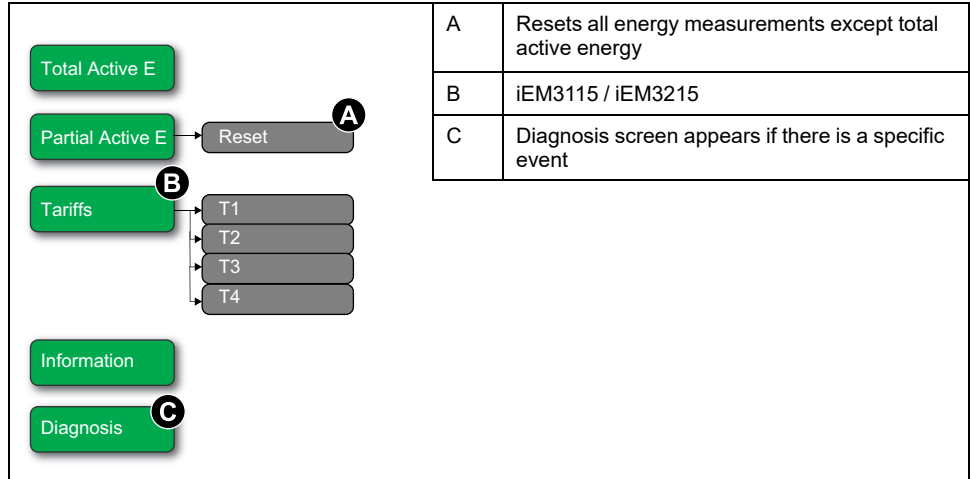

Data display screens: iEM3150 / iEM3250 / iEM3350

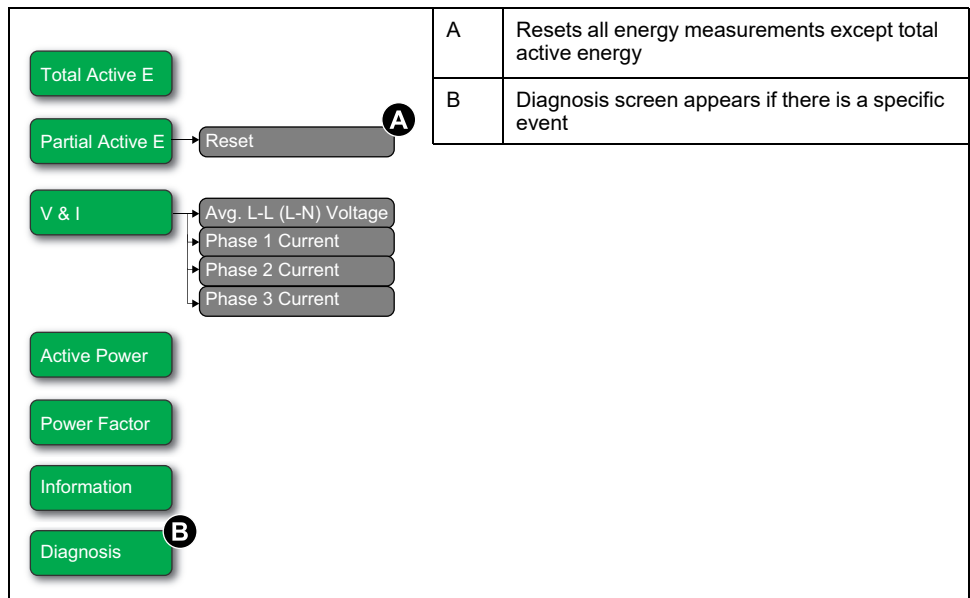

Data display screens: iEM3135 / iEM3155 / iEM3165 / iEM3175 / iEM3235 / iEM3255 / iEM3265 / iEM3275 / iEM3335 / iEM3355 / iEM3365 / iEM3375

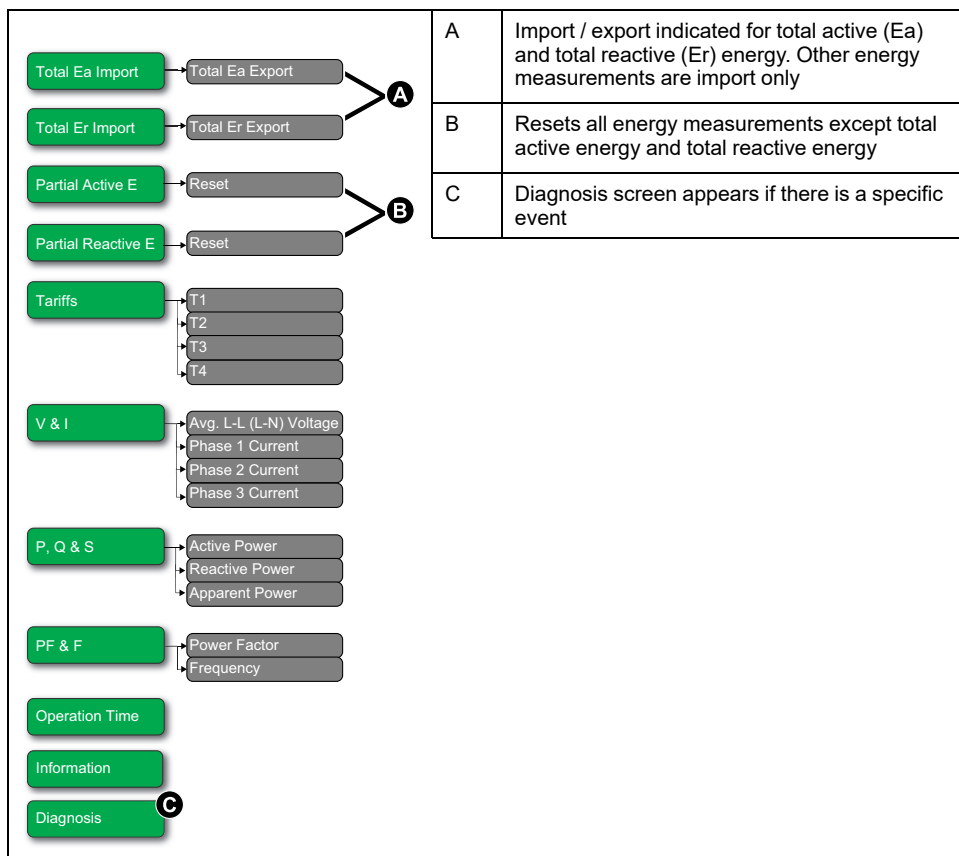

Resets

The following resets are available:

| Reset | Description |
|----------------|--|
| Partial energy | Clears all active and reactive energy accumulated since the last reset. This does not reset the total active and reactive energy accumulation. |
| Input metering | Clears all input metering energy data. You can only reset the input metering accumulation using software. |

Resetting accumulated energy using the display

1. Navigate to the **Partial Active E** or **Partial Reactive E** screen. The screen displays the date of the last reset. For example:

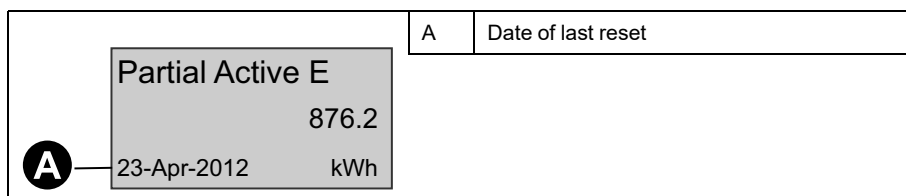

2. Press and hold **ESC**. The **Reset** screen appears.

3. Press **OK** to confirm the reset and enter the meter password when prompted.

NOTE: Regardless of the screen you use to access this reset, accumulations of both Partial Active Energy and the Partial Reactive Energy (if available) are cleared.

Multi Tariff feature

The Multi Tariff feature is available on iEM3115 / iEM3135 / iEM3155 / iEM3165 / iEM3175 / iEM3215 / iEM3235 / iEM3255 / iEM3265 / iEM3275 / iEM3335 / iEM3355 / iEM3365 / iEM3375 meter models.

The table below illustrates how the tariffs operate according to the tariff selection (2, 3 or 4 tariffs). These tariffs are stored in 4 different registers: T1, T2, T3 and T4.

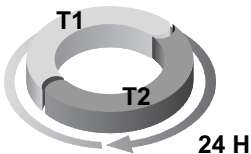
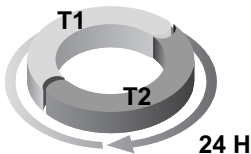
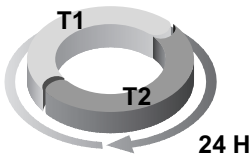
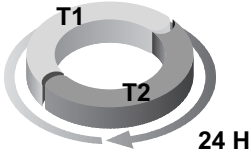
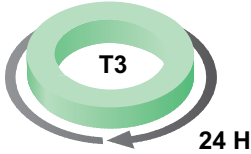
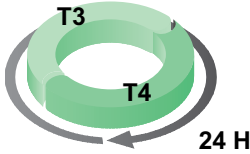
| | 2 tariffs | 3 tariffs | 4 tariffs |
|---------|--|---|--|
| Weekday |  |  |  |
| Weekend |  |  |  |

NOTE: If the tariff Control Mode is set to by Internal Clock, the start time of the next tariff is the end time of the current tariff. For example, T2 start equals the end of T1.

Meter information

Meter information (for example, model and firmware version) is available on the information screen. In display mode, press the down arrow until you reach the information screen:

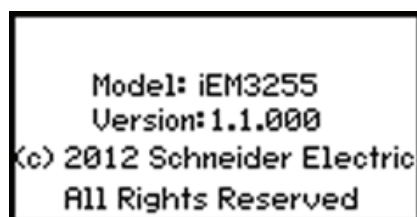

The device clock

Not applicable for iEM3100 / iEM3200 / iEM3300 meter models.

You must reset the time to account for any time change (for example, to switch the time from standard time to daylight savings time).

Clock behavior: iEM3110 / iEM3210 / iEM3150 / iEM3250 / iEM3310 / iEM3350:

You are not prompted to set the date and time when the meter is powered up. You can enter configuration mode to set the date and time. If you have not set the clock, the following icon appears on the display: .

When power is interrupted, the date and time are reset and you must enter configuration mode to configure the clock, if you require time information.

Clock behavior: iEM3115 / iEM3135 / iEM3155 / iEM3165 / iEM3175 / iEM3215 / iEM3235 / iEM3255 / iEM3265 / iEM3275 / iEM3335 / iEM3355 / iEM3365 / iEM3375:

You are prompted to set the date and time when the meter is powered up. Press  to skip this step if you do not want to set the clock (you can enter configuration mode and set the date and time later, if required).

When the power is interrupted, the device retains its date and time information for 3 days. If power is interrupted for longer than 3 days, the device automatically displays the screen to set **Date & Time** when power is restored.

Date/time format

The date is displayed in the following format: DD-MMM-YYYY.

The time is displayed using the 24-hour clock in the following format: hh:mm:ss.

Setting the clock initially

The image below illustrates how to set the clock when you initially power up the device or after a power failure. To set the clock during normal operation, refer to Device configuration, page 37.

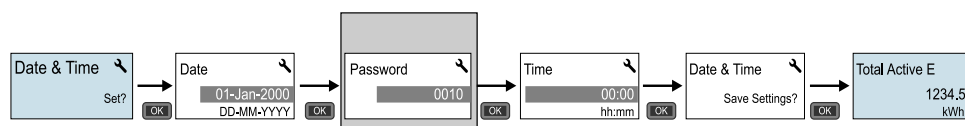

NOTE: Password entry is only required for meters that support a password.

Device configuration

The default factory settings (as applicable based on your model) are listed in the table below:

| Menu | Factory settings |
|---------------|--|
| Wiring | iEM3100 series: 3PH4W iEM3200 series: 3PH4W; 3 CTs on I1, I2, and I3; Direct-No VT iEM3300 series: 3PH4W |
| CT Ratio | Varies depending on meter model |
| CT & VT Ratio | Varies depending on meter model |
| Frequency | 50 Hz |

| Menu | Factory settings |
|----------------|------------------------------|
| Date | 1-Jan-2000 |
| Time | 00:00:00 |
| Multi Tariffs | Disable |
| Overload Alarm | Disable |
| Digital Output | Disable |
| Digital Input | Input Status |
| Pulse Output | 100 imp/kWh |
| Communication | Varies depending on protocol |
| Com.Protection | Enable |
| Contrast | 5 |
| Password | 0010 |

Entering configuration mode

1. Press and hold **OK** and **ESC** at the same time for about 2 seconds.
2. Enter the meter password, if prompted. The **Access Counter** screen displays, indicating the number of times the configuration mode has been accessed.

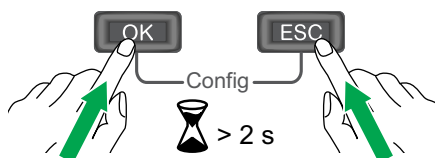

The front panel display in configuration mode

The image below illustrates the various elements of the display in configuration mode:

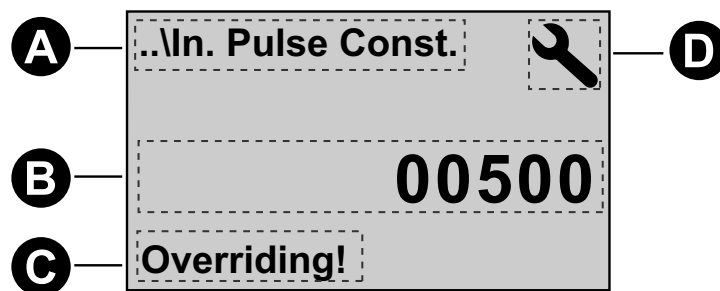

| | |
|---|---|
| A | Parameter |
| B | Setting |
| C | Indicates that the setting impacts the Multi Tariff feature |
| D | Configuration mode icon |

Com. Protection setting

For meters with communications capabilities, you can enable or disable the Com. Protection setting. If this setting is enabled, you must use the display to configure

certain settings (for example, wiring or frequency, etc.) and perform resets; you cannot use communications.

The protected settings and resets are:

- Power system settings (for example, wiring, frequency, CT ratios)
- Date and time settings
- Multi Tariff settings
- Communications settings
- Partial energy reset



Modifying parameters

There are two methods for modifying a parameter, depending on the type of parameter:

- Selecting a value in a list (for example, selecting 1PH2W L-N from a list of available power systems), or
- Modifying a numerical value, digit by digit (for example, entering a value for the date, time or VT primary).

NOTE: Before you modify any parameters, ensure that you are familiar with the HMI functionality and navigation structure of your device in configuration mode.





Selecting a value from a list

1. Use the  button to scroll through the parameter values until you reach the desired value.
2. Press  to confirm the new parameter value.

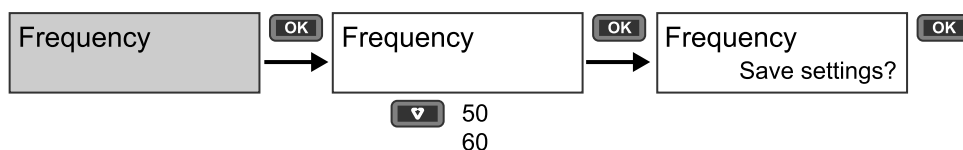
Example: Configuring a list value

To set the nominal frequency of the meter:



1. Enter configuration mode and press the  button until you reach **Frequency** then press  to access the frequency configuration.
2. Press the  button to select the frequency you want then click . Press  again to save your changes.

Modifying a numerical value



When you modify a numerical value, the digit on the far right side is selected by default (except for Date/Time).

The parameters listed below are the only ones for which you set a numerical value (if the parameter is available on your device):

- Date
- Time
- Pick Up Value for an overload alarm

- Voltage Transformer (VT) Primary
- Current Transformer (CT) Primary
- Password
- Address of the meter

To modify a numerical value:





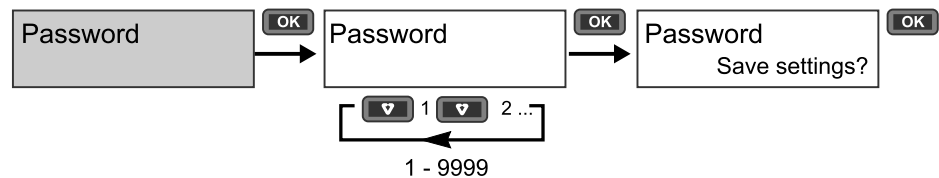

1. Use the  button to modify the selected digit.
2. Press  to shift to next digit. Modify the next digit, if needed, or press okay to move to the next digit. Continue to move through the digits until you reach the last digit then press  again to confirm the new parameter value.

If you enter an invalid setting for the parameter, when you press  after setting the left-most number, the cursor shifts back to the right-most number so you can enter a valid value.

Example: configuring a numeric value

To set the password:



1. Enter configuration mode and press the  button until you reach **Password** then press  to access the password configuration.
2. Press the  button to increment the selected digit or press  to move to the next digit to the left. When you reach the left-most digit, press  to move to the next screen. Press  again to save your changes.

Cancelling an entry

To cancel the current entry, press the  button. The change is cancelled and the screen reverts to the previous display.

Configuration mode menus

The images below show the configuration navigation for each device.

Configuration menu for iEM3100 / iEM3110 / iEM3115 / iEM3300 / iEM3310

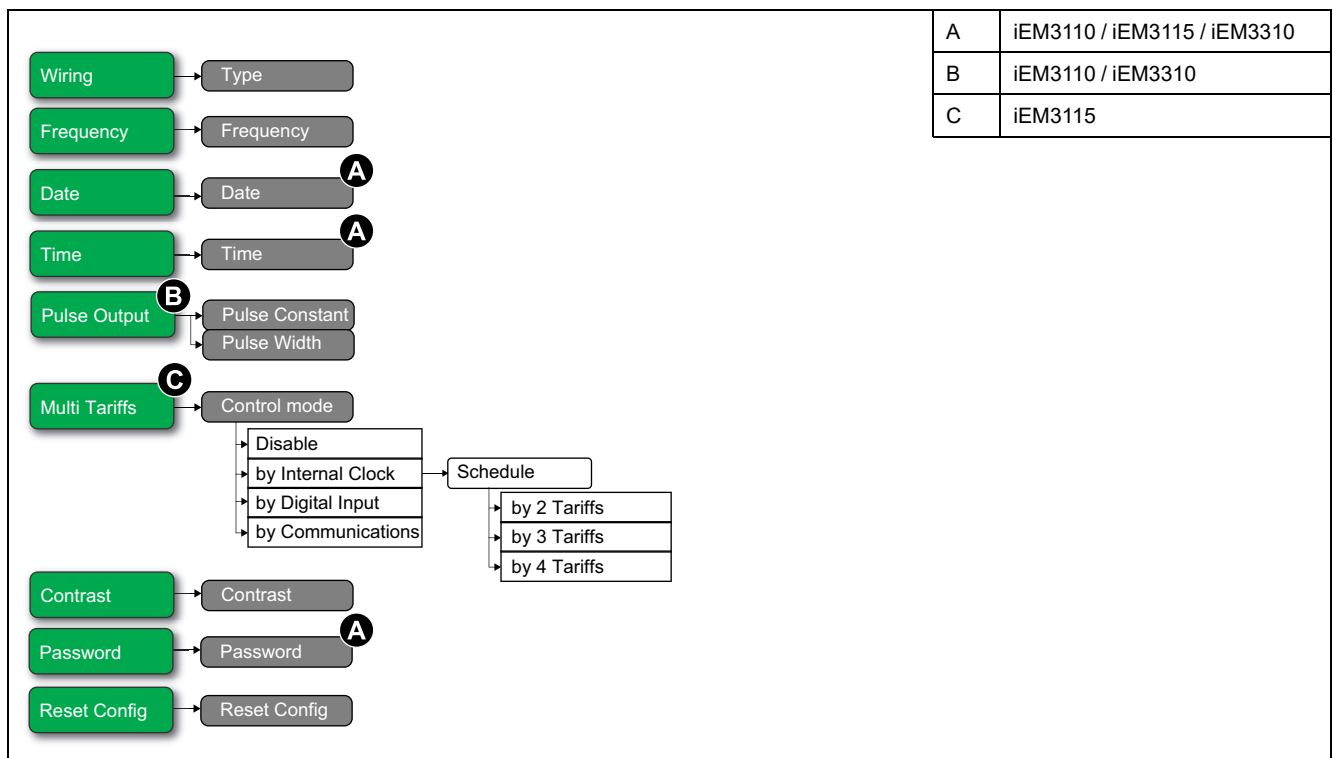

| Section | Parameter | Options | Description |
|---|-----------------------------|---|---|
| Wiring | Type | 3PH3W 3PH4W 1PH2W L-N 1PH2W L-L 1PH3W L-L-N | Select the power system type the meter is wired to. |
| Frequency | Frequency | 50 60 | Select the frequency of the electrical power system, in Hz. |
| Date (iEM3110 / iEM3115 / iEM3310) | Date | DD-MMM-YYYY | Set the current date using the specified format. |
| Time (iEM3110 / iEM3115 / iEM3310) | Time | hh:mm | Use the 24-hour format to set the time. |
| Pulse Output (iEM3110 / iEM3310) | Pulse Constant (imp/kWh) | 100 200 1000 1 10 20 | Set the pulses per kWh for the pulse output. |
| | Pulse Width (ms) | 50 100 200 300 | Set the pulse width (ON time). |

| Section | Parameter | Options | Description |
|--|--------------|--|---|
| Multi Tariffs (iEM3115) | Control Mode | Disable by Digital Input by Internal Clock | Select the tariff control mode: <ul style="list-style-type: none"> • Disable: the Multi Tariff function is disabled. • by Digital Input: the digital input is associated with the Multi Tariff function. A signal to the digital input changes the active tariff. • by Internal Clock: the device clock controls the active tariff. If you set the Control Mode to by Internal Clock, you must also configure the schedule. Set the time when each tariff period starts, using the 24 hour clock format (00:00 to 23:59). The start time of the next tariff is the end time of the current tariff. For example, T2 start equals the end of T1. |
| Contrast | Contrast | 1 – 9 | Increase or decrease the value to increase or decrease the display contrast. |
| Password (iEM3110 / iEM3115 / iEM3310) | Password | 0 – 9999 | Sets the password for accessing the meter configuration screens and resets. |
| Reset Config | Reset Config | — | Settings are reset to their defaults, except for Password. Meter restarts. |

Configuration menu for iEM3150 / iEM3350

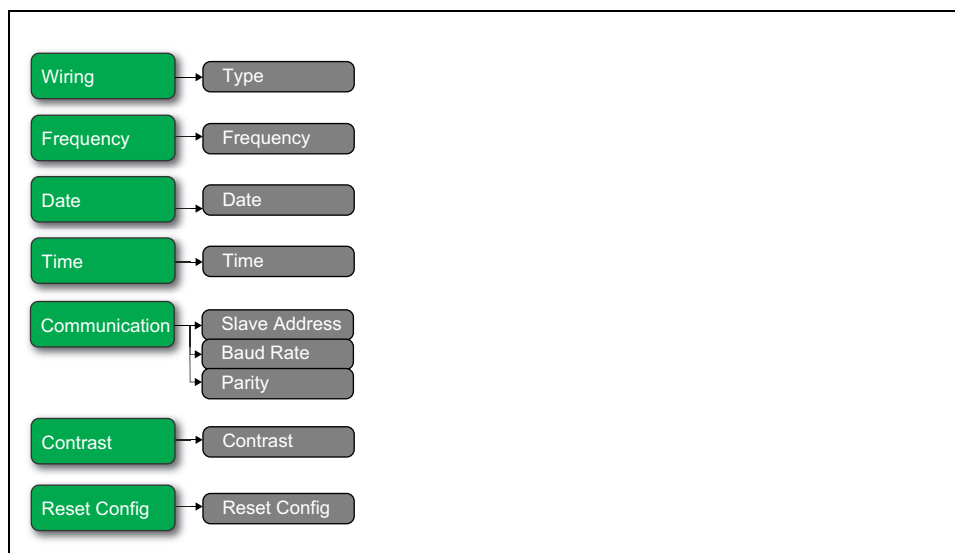

| Section | Parameter | Options | Description |
|-----------|-----------|--|---|
| Wiring | Type | 3PH4W 1PH2W L-N 1PH2W L-L 1PH3W L-L-N 3PH3W 1PH4W Multi L-N | Select the power system type the meter is wired to. |
| Frequency | Frequency | 50 60 | Select the frequency of the electrical power system, in Hz. |
| Date | Date | DD-MMM-YYYY | Set the current date using the specified format. |
| Time | Time | hh:mm | Set the time using the 24-hour format. |

| Section | Parameter | Options | Description |
|---------------|---------------|------------------------|---|
| Communication | Slave Address | 1 – 247 | Set the address for this device. The address must be unique for each device in a communications loop. |
| | Baud Rate | 19200 38400 9600 | Select the speed for data transmission. The baud rate must be the same for all devices in a communications loop. |
| | Parity | Even Odd None | Select None if the parity bit is not used. The parity setting must be the same for all devices in a communications loop. NOTE: Number of stop bits = 1. |
| Contrast | Contrast | 1 – 9 | Increase or decrease the value to increase or decrease the display contrast. |
| Reset Config | Reset Config | — | Settings are reset to their defaults, except for Password. Meter restarts. |

Configuration menu for iEM3135 / iEM3155 / iEM3165 / iEM3175 / iEM3335 / iEM3355 / iEM3365 / iEM3375

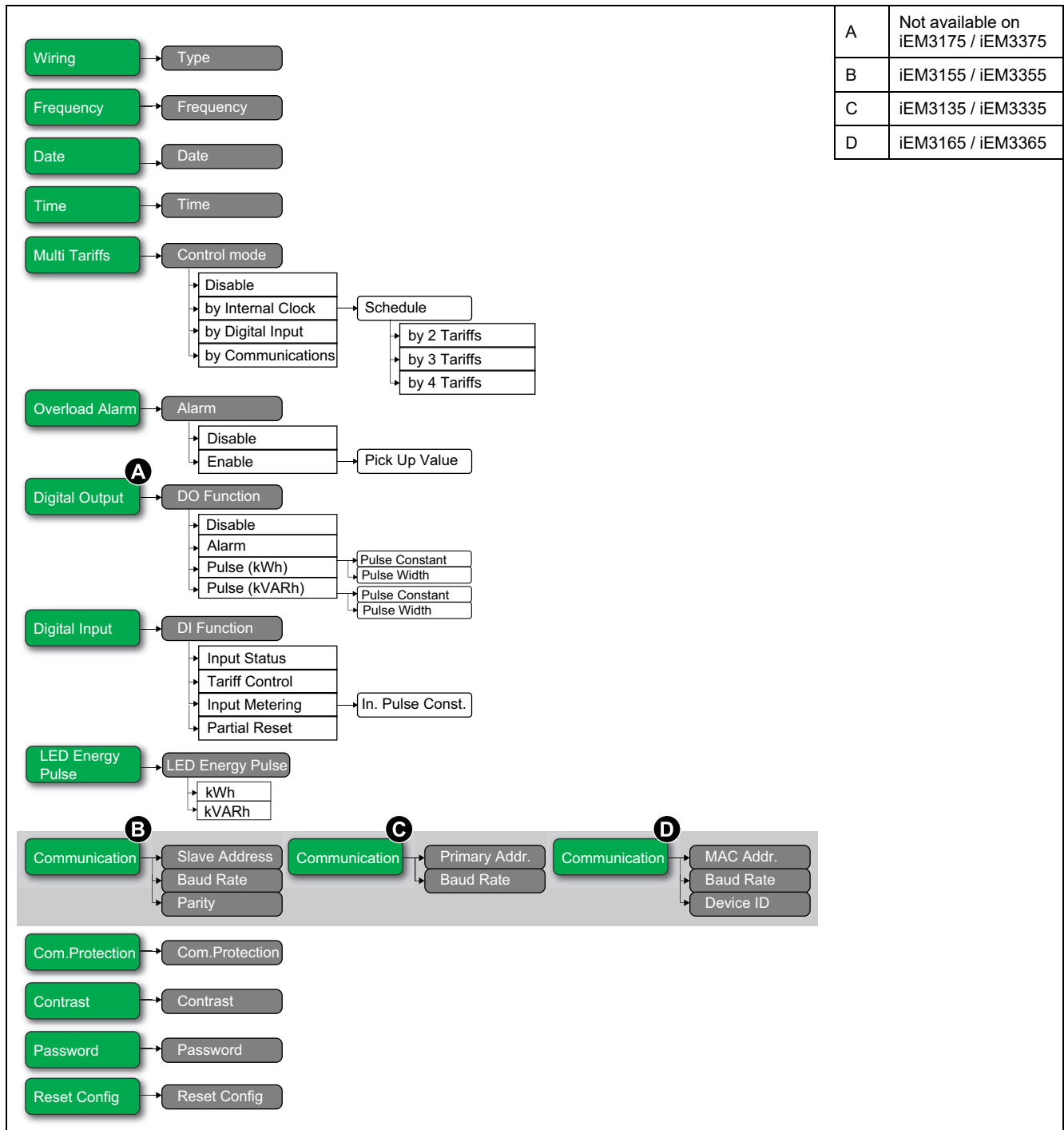

| Section | Parameter | Options | Description |
|-----------|-----------|--|---|
| Wiring | Type | 3PH4W 1PH2W L-N 1PH2W L-L 1PH3W L-L-N 3PH3W 1PH4W Multi L-N | Select the power system type the meter is wired to. |
| Frequency | Frequency | 50 60 | Select the frequency of the electrical power system, in Hz. |
| Date | Date | DD-MMM-YYYY | Set the current date using the specified format. |
| Time | Time | hh:mm | Set the time using the 24-hour format. |

| Section | Parameter | Options | Description |
|--|---------------|--|--|
| Multi Tariffs | Control Mode | Disable by Communication by Digital Input by Internal Clock | Select the tariff control mode: <ul style="list-style-type: none"> Disable: the Multi Tariff function is disabled. by Communication: the active tariff is control by communications. See the chapter for the applicable protocol for more information. by Digital Input: the digital input is associated with the Multi Tariff function. A signal to the digital input changes the active tariff. by Internal Clock: the device clock controls the active tariff. If you set the Control Mode to by Internal Clock, you must also configure the schedule. Set the time when each tariff period starts, using the 24 hour clock format (00:00 to 23:59). The start time of the next tariff is the end time of the current tariff. For example, T2 start equals the end of T1. |
| Overload Alarm | Alarm | Disable Enable | Select whether or not the Overload Alarm is enabled: <ul style="list-style-type: none"> Disable: the alarm is disabled. Enable: the alarm is enabled. If you enabled the Overload Alarm, you must also configure the Pick Up Value in kW from 1 - 9999999. |
| Digital Output (Not available on iEM3175 / iEM3375) | DO Function | Disable Alarm Pulse (kWh) Pulse (kVARh) | Select how the digital output functions: <ul style="list-style-type: none"> Disable: the digital output is disabled. Alarm: the digital output is associated with the overload alarm. In the event of trigger, the digital output remains in the ON state until the alarm drop out point is crossed. Pulse (kWh): The digital output is associated with energy pulsing (active energy). When this mode is selected, you can select the energy parameter and set the Pulse Constant (imp/kWh) and the Pulse Width (ms). Pulse (kVARh): The digital output is associated with energy pulsing (reactive energy). When this mode is selected, you can select the energy parameter and set the Pulse Constant (imp/kVARh) and the Pulse Width (ms). |
| Digital Input | DI Function | Input Status Tariff Control Input Metering Partial Reset | Select how the digital input functions: <ul style="list-style-type: none"> Input status: the digital input records the status of the input, for example, OF, SD of a circuit breaker. Tariff Control: the digital input is associated with the Multi Tariff function. A signal to the digital input changes the active tariff. Input Metering: the digital input is associated with input metering. The meter counts and records the number of incoming pulses. If you set the DI Function to Input Metering, you must also configure In. Pulse Constant. Partial Reset: a signal to the digital input initiates a partial reset. |
| LED Energy Pulse | Energy | kWh kVARh | Set the active energy and reactive energy. |
| Communication (iEM3155 / iEM3355) | Slave Address | 1 – 247 | Set the address for this device. The address must be unique for each device in a communications loop. |
| | Baud Rate | 19200 38400 9600 | Select the speed for data transmission. The baud rate must be the same for all devices in a communications loop. |
| | Parity | Even Odd None | Select None if the parity bit is not used. The parity setting must be the same for all devices in a communications loop. NOTE: Number of stop bits = 1. |
| Communication (iEM3135 / iEM3335) | Primary Addr. | 0 – 255 | Set the address for this device. The address must be unique for each device in a communications loop. |
| | Baud Rate | 2400 4800 9600 300 600 1200 | Select the speed for data transmission. The baud rate must be the same for all devices in a communications loop. |

| Section | Parameter | Options | Description |
|---|----------------|--|--|
| Communication (iEM3165 / iEM3365) | MAC Addr. | 1 – 127 | Set the address for this device. The address must be unique for each device in a communications loop. |
| | Baud Rate | 9600 19200 38400 57600 76800 | Select the speed for data transmission. The baud rate must be the same for all devices in a communications loop. |
| | Device ID | 0 – 4194303 | Set the Device ID for this device. Make sure the Device ID is unique in your BACnet network. |
| Com.Protection | Com.Protection | Enable Disable | Protects selected settings and resets from configuration via communications. |
| Contrast | Contrast | 1 – 9 | Increase or decrease the value to increase or decrease the display contrast. |
| Password | Password | 0 – 9999 | Sets the password for accessing the meter configuration screens and resets. |
| Reset Config | Reset Config | — | Settings are reset to their defaults, except for Password. Meter restarts. |

Configuration menu for iEM3200 / iEM3210 / iEM3215

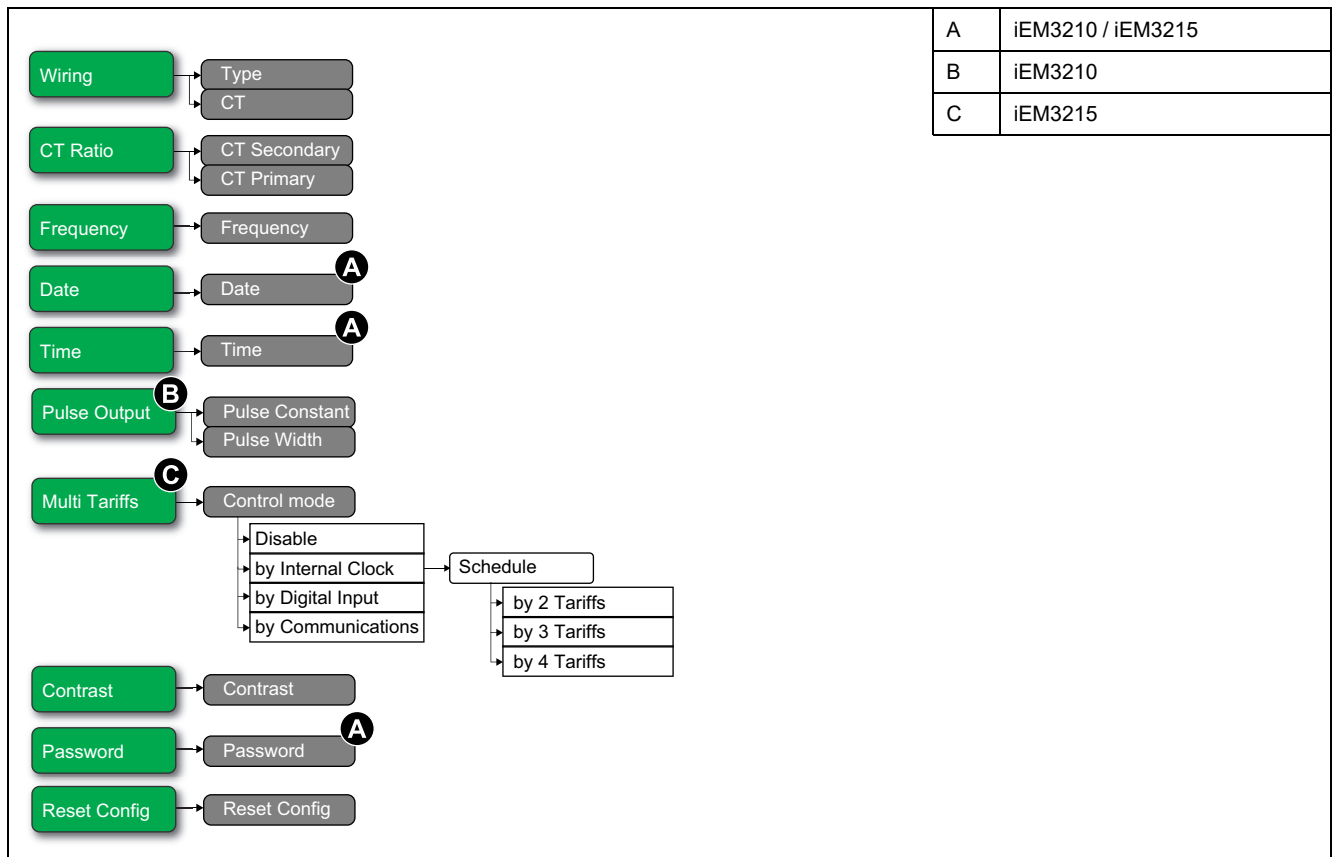

| Section | Parameter | Options | Description |
|------------------------------------|-----------------------------|--|--|
| Wiring | Type | 3PH3W 3PH4W 1PH2W L-N 1PH2W L-L 1PH3W L-L-N | Select the power system type the meter is wired to. |
| | CT | 3CTs on I1, I2, I3 1 CT on I1 2 CTs on I1, I3 | Define how many current transformers (CT) are connected to the meter and which terminals they are connected to. |
| CT Ratio | CT Secondary | 1 5 | Select the size of the CT secondary, in Amps. |
| | CT Primary | 1 to 32767 | Enter the size of the CT primary, in Amps. |
| Frequency | Frequency | 50 60 | Select the frequency of the electrical power system, in Hz. |
| Date (iEM3210 / iEM3215) | Date | DD-MMM-YYYY | Set the current date using the specified format. |
| Time (iEM3210 / iEM3215) | Time | hh:mm | Set the time using the 24-hour format. |
| Pulse Output (iEM3210) | Pulse Constant (imp/kWh) | 0.01 0.1 1 10 100 500 | Set the pulses per kWh for the pulse output. |
| | Pulse Width (ms) | 50 100 200 300 | Set the pulse width (ON time). |
| Multi Tariffs (iEM3215) | Control Mode | Disable by Digital Input by Internal Clock by Communication | Select the tariff control mode: <ul style="list-style-type: none"> • Disable: the Multi Tariff function is disabled. • by Communication: the active tariff is control by communications. See the chapter for the applicable protocol for more information. • by Digital Input: the digital input is associated with the Multi Tariff function. A signal to the digital input changes the active tariff. • by Internal Clock: the device clock controls the active tariff. If you set the Control Mode to by Internal Clock, you must also configure the schedule. Set the time when each tariff period starts, using the 24 hour clock format (00:00 to 23:59). The start time of the next tariff is the end time of the current tariff. For example, T2 start equals the end of T1. |
| Contrast | Contrast | 1 – 9 | Increase or decrease the value to increase or decrease the display contrast. |
| Password (iEM3210 / iEM3215) | Password | 0 – 9999 | Sets the password for accessing the meter configuration screens and resets. |
| Reset Config | Reset Config | — | Settings are reset to their defaults, except for Password. Meter restarts. |

Configuration menu for iEM3250

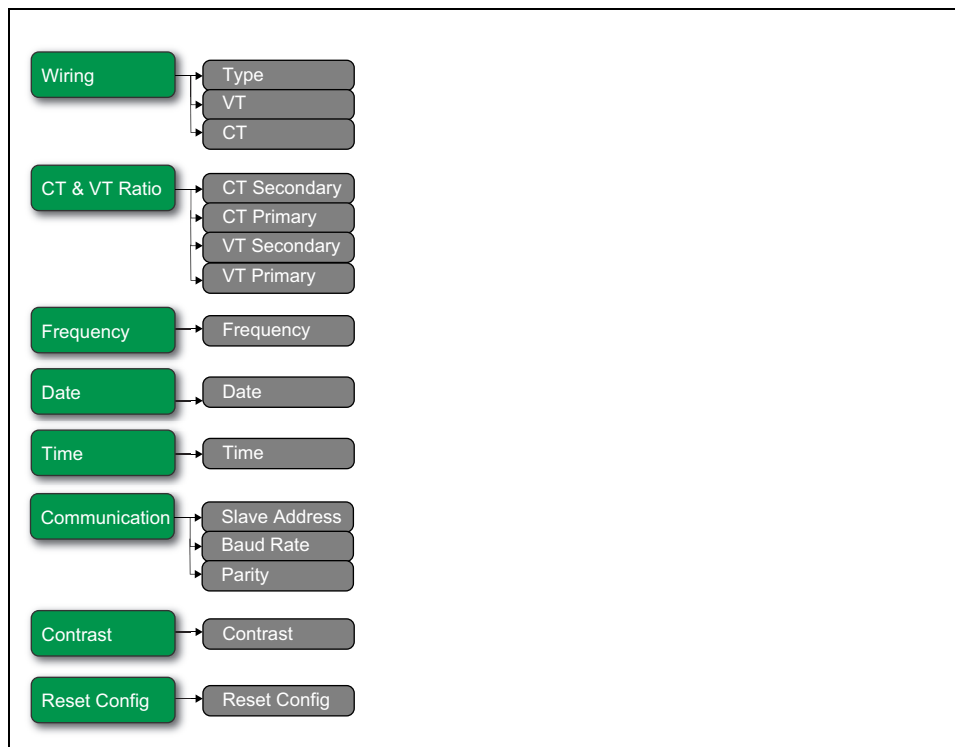

| Section | Parameter | Options | Description |
|---------------|--------------|--|---|
| Wiring | Type | 3PH4W 1PH2W L-N 1PH2W L-L 1PH3W L-L-N 3PH3W 1PH4W Multi L-N | Select the power system type the meter is wired to. |
| | VT | Direct-NoVT Wye (3VTs) Delta (2VTs) | Select how many voltage transformers (VT) are connected to the electrical power system. |
| | CT | 3CTs on I1, I2, I3 1 CT on I1 2 CTs on I1, I3 | Define how many current transformers (CT) are connected to the meter and which terminals they are connected to. |
| CT & VT Ratio | CT Secondary | 1 5 | Select the size of the CT secondary, in Amps. |
| | CT Primary | 1 to 32767 | Enter the size of the CT primary, in Amps. |
| | VT Secondary | 100 110 115 120 | Select the size of the VT secondary, in Volts. |
| | VT Primary | 1 to 1000000 | Enter the size of the VT primary, in Volts. |
| Frequency | Frequency | 50 60 | Select the frequency of the electrical power system, in Hz. |
| Date | Date | DD-MMM-YYYY | Set the current date using the specified format. |
| Time | Time | hh:mm | Set the time using the 24-hour format. |

| Section | Parameter | Options | Description |
|---------------|---------------|------------------------|---|
| Communication | Slave Address | 1 – 247 | Set the address for this device. The address must be unique for each device in a communications loop. |
| | Baud Rate | 19200 38400 9600 | Select the speed for data transmission. The baud rate must be the same for all devices in a communications loop. |
| | Parity | Even Odd None | Select None if the parity bit is not used. The parity setting must be the same for all devices in a communications loop. NOTE: Number of stop bits = 1. |
| Contrast | Contrast | 1 – 9 | Increase or decrease the value to increase or decrease the display contrast. |
| Reset Config | Reset Config | — | Settings are reset to their defaults, except for Password. Meter restarts. |

Configuration menu for iEM3235 / iEM3255 / iEM3265 / iEM3275

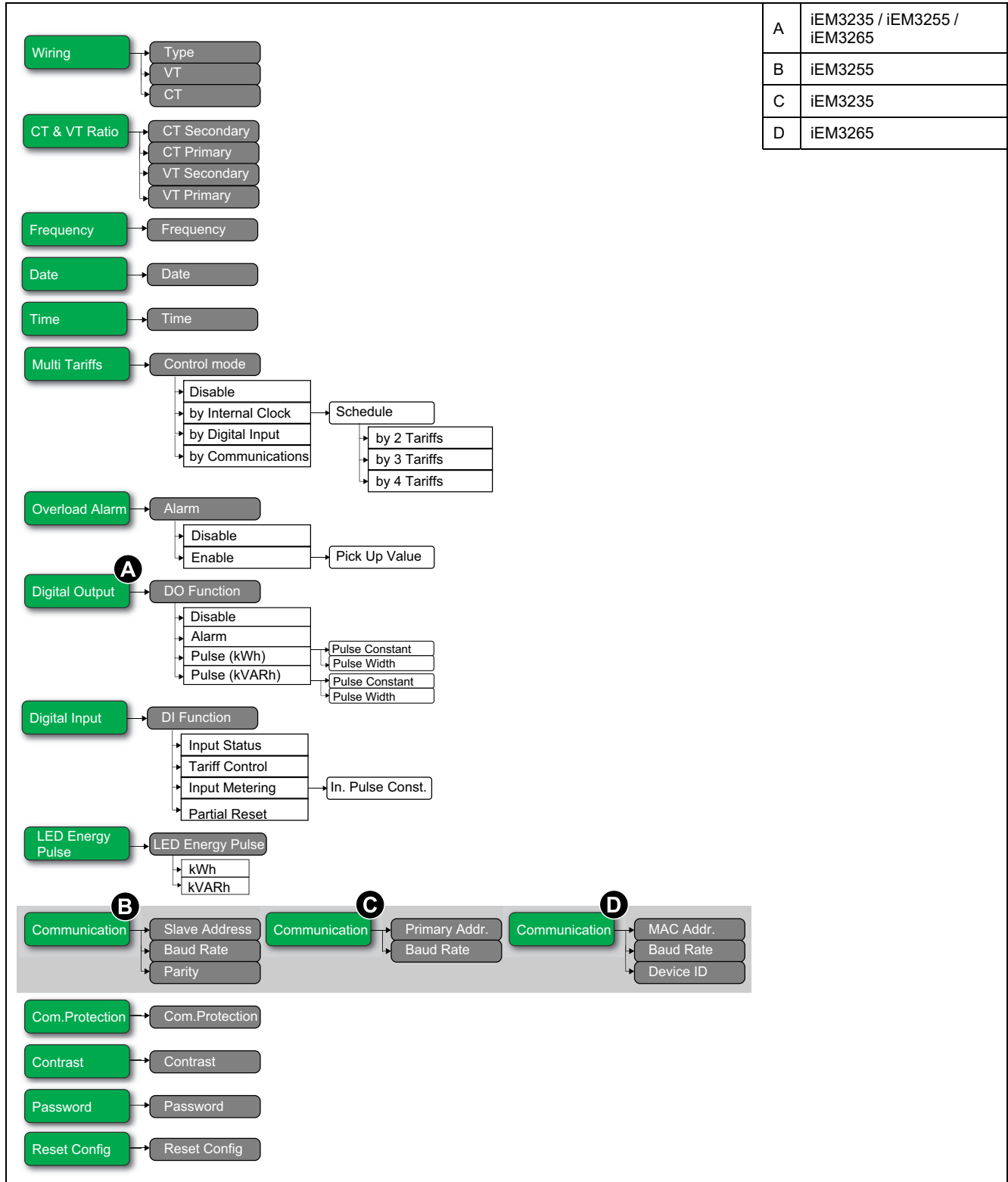

| Section | Parameter | Options | Description |
|---|--------------|--|--|
| Wiring | Type | 3PH3W 3PH4W 1PH2W L-N 1PH2W L-L 1PH3W L-L-N 1PH4W Multi L-N | Select the power system type the meter is wired to. |
| | VT | Direct-NoVT Wye (3VTs) Delta (2VTs) | Select how many voltage transformers (VT) are connected to the electrical power system. |
| | CT | 3CTs on I1, I2, I3 1 CT on I1 2 CTs on I1, I3 | Define how many current transformers (CT) are connected to the meter and which terminals they are connected to. |
| CT & VT Ratio | CT Secondary | 1 5 | Select the size of the CT secondary, in Amps. |
| | CT Primary | 1 to 32767 | Enter the size of the CT primary, in Amps. |
| | VT Secondary | 100 110 115 120 | Select the size of the VT secondary, in Volts. |
| | VT Primary | 1 to 1000000 | Enter the size of the VT primary, in Volts. |
| Frequency | Frequency | 50 60 | Select the frequency of the electrical power system, in Hz. |
| Date | Date | DD-MMM-YYYY | Set the current date using the specified format. |
| Time | Time | hh:mm | Set the time using the 24-hour format. |
| Multi Tariffs | Control Mode | Disable by Communication by Digital Input by Internal Clock | Select the tariff control mode: <ul style="list-style-type: none"> Disable: the Multi Tariff function is disabled. by Communication: the active tariff is control by communications. See the chapter for the applicable protocol for more information. by Digital Input: the digital input is associated with the Multi Tariff function. A signal to the digital input changes the active tariff. by Internal Clock: the device clock controls the active tariff. If you set the Control Mode to by Internal Clock, you must also configure the schedule. Set the time when each tariff period starts, using the 24 hour clock format (00:00 to 23:59). The start time of the next tariff is the end time of the current tariff. For example, T2 start equals the end of T1. |
| Overload Alarm | Alarm | Disable Enable | Select whether or not the Overload Alarm is enabled: <ul style="list-style-type: none"> Disable: the alarm is disabled. Enable: the alarm is enabled. If you enabled the Overload Alarm, you must also configure the Pick Up Value in kW from 1 - 9999999. |
| Digital Output (iEM3235 / iEM3255 / iEM3265) | DO Function | Disable Alarm Pulse (kWh) Pulse (kVARh) | Select how the digital output functions: <ul style="list-style-type: none"> Disable: the digital output is disabled. Alarm: the digital output is associated with the overload alarm. In the event of trigger, the digital output remains in the ON state until the alarm drop out point is crossed. Pulse (kWh): The digital output is associated with energy pulsing (active energy). When this mode is selected, you can select the energy parameter and set the Pulse Constant (imp/kWh) and the Pulse Width (ms). Pulse (kVARh): The digital output is associated with energy pulsing (reactive energy). When this mode is selected, you can select the energy parameter and set the Pulse Constant (imp/kVARh) and the Pulse Width (ms). <p>NOTE: The iEM3275 does not have a digital output.</p> |

| Section | Parameter | Options | Description |
|-------------------------|----------------|---|---|
| Digital Input | DI Function | Input Status Tariff Control Input Metering Partial Reset | Select how the digital input functions: <ul style="list-style-type: none"> Input status: the digital input records the status of the input, for example, OF, SD of a circuit breaker. Tariff Control: the digital input is associated with the Multi Tariff function. A signal to the digital input changes the active tariff. Input Metering: the digital input is associated with input metering. The meter counts and records the number of incoming pulses. If you set the DI Function to Input Metering, you must also configure In. Pulse Constant. Partial Reset: a signal to the digital input initiates a partial reset. |
| LED Energy Pulse | Energy | kWh kVARh | Set the active energy and reactive energy. |
| Communication (iEM3255) | Slave Address | 1 – 247 | Set the address for this device. The address must be unique for each device in a communications loop. |
| | Baud Rate | 19200 38400 9600 | Select the speed for data transmission. The baud rate must be the same for all devices in a communications loop. |
| | Parity | Even Odd None | Select None if the parity bit is not used. The parity setting must be the same for all devices in a communications loop. NOTE: Number of stop bits = 1. |
| Communication (iEM3235) | Primary Addr. | 0 – 255 | Set the address for this device. The address must be unique for each device in a communications loop. |
| | Baud Rate | 2400 4800 9600 300 600 1200 | Select the speed for data transmission. The baud rate must be the same for all devices in a communications loop. |
| Communication (iEM3265) | MAC Addr. | 1 – 127 | Set the address for this device. The address must be unique for each device in a communications loop. |
| | Baud Rate | 9600 19200 38400 57600 76800 | Select the speed for data transmission. The baud rate must be the same for all devices in a communications loop. |
| | Device ID | 0 – 4194303 | Set the Device ID for this device. Make sure the Device ID is unique in your BACnet network. |
| Com.Protection | Com.Protection | Enable Disable | Protects selected settings and resets from configuration via communications. |
| Contrast | Contrast | 1 – 9 | Increase or decrease the value to increase or decrease the display contrast. |
| Password | Password | 0 – 9999 | Sets the password for accessing the meter configuration screens and resets. |
| Reset Config | Reset Config | — | Settings are reset to their defaults, except for Password. Meter restarts. |

Communications via Modbus

Modbus communication overview

Modbus RTU protocol is available on iEM3150 / iEM3155 / iEM3250 / iEM3255 / iEM3350 / iEM3355 meter models.

The information in this section assumes that you have an advanced understanding of Modbus communications, your communications network and the power system that your meter is connected to.

There are three different ways of using Modbus communication:

- By sending commands using the command interface
- By reading the Modbus registers
- By reading Device Identification

Modbus communications settings

Before communicating with the device using Modbus protocol, use the display to configure the following settings:

| Settings | Possible values |
|-----------|---|
| Baud rate | 9600 Baud 19200 Baud 38400 Baud |
| Parity | Odd Even None NOTE: Number of stop bits = 1 |
| Address | 1 – 247 |

Communications LED indicator for Modbus devices

The yellow communications LED indicates the status of communication between the meter and the master as follows:

| If... | Then... |
|---------------------|--|
| The LED is flashing | Communication with the device has been established. NOTE: If there is an error online, the LED also flashes. |
| The LED is off | There is no active communication between the master and the slave |

Modbus functions

Function list

The table below lists the supported Modbus functions:

| Function code | | Function name |
|---------------|-------------|----------------------------|
| Decimal | Hexadecimal | |
| 3 | 0x03 | Read Holding Registers |
| 16 | 0x10 | Write Multiple Registers |
| 43/14 | 0x2B/0x0E | Read Device Identification |

For example:

- To read different parameters from the meter, use function 3 (Read).
- To change the tariff, use function 16 (Write) to send a command to the meter.

Table format

Register tables have the following columns:

| Address | Register | Action (R/W/WC) | Size | Type | Units | Range | Description |
|---------|----------|-----------------|------|------|-------|-------|-------------|
|---------|----------|-----------------|------|------|-------|-------|-------------|

- **Address:** A 16-bit register address in hexadecimal. The address is the data used in the Modbus frame.
- **Register:** A 16-bit register number in decimal (register = address + 1).
- **Action:** The read/write/write by command property of the register.
- **Size:** The data size in Int16.
- **Type:** The encoding data type.
- **Units:** The unit of the register value.
- **Range:** The permitted values for this variable, usually a subset of what the format allows.
- **Description:** Provides information about the register and the values that apply.

Unit table

The following data types appear in the Modbus register list:

| Type | Description | Range |
|----------|-------------------------|---|
| UInt16 | 16 bit unsigned integer | 0 to 65535 |
| Int16 | 16 bit signed integer | -32768 to +32767 |
| UInt32 | 32 bit unsigned integer | 0 to 4 294 967 295 |
| Int64 | 64 bit unsigned integer | 0 to 18 446 744 073 709 551 615 |
| UTF8 | 8 bit field | Multi byte character encoding for Unicode |
| Float32 | 32 bit value | Standard representation IEEE for floating number (with single precision)) |
| Bitmap | — | — |
| DATETIME | See below table | — |

DATETIME format:

| Word | Bits | | | | | | | | | | | | | | | | |
|------|----------|----|----|---------------|----------------|----|---|----|--------|-----------------|---|---|--------------|---|---|---|--|
| | 15 | 14 | 13 | 12 | 11 | 10 | 9 | 8 | 7 | 6 | 5 | 4 | 3 | 2 | 1 | 0 | |
| 1 | Reserved | | | | | | | | R4 (0) | Year (0 – 127) | | | | | | | |
| 2 | 0 | | | | Month (1 – 12) | | | | WD (0) | | | | Day (1 – 31) | | | | |
| 3 | SU (0) | 0 | | Hour (0 – 23) | | | | iV | 0 | Minute (0 – 59) | | | | | | | |

DATETIME format: (Continued)

| Word | Bits | | | | | | | | | | | | | | | |
|----------------------------------|---|----|----|----|----|----|---|---|---|---|---|---|---|---|---|---|
| | 15 | 14 | 13 | 12 | 11 | 10 | 9 | 8 | 7 | 6 | 5 | 4 | 3 | 2 | 1 | 0 |
| 4 | Millisecond (0 – 59999) | | | | | | | | | | | | | | | |
| R4 : | Reserved Bit | | | | | | | | | | | | | | | |
| Year : | 7 bits (year from 2000) | | | | | | | | | | | | | | | |
| Month : | 4 bits | | | | | | | | | | | | | | | |
| Day : | 5 bits | | | | | | | | | | | | | | | |
| Hour : | 5 bits | | | | | | | | | | | | | | | |
| Minute : | 6 bits | | | | | | | | | | | | | | | |
| Millisecond : | 2 octets | | | | | | | | | | | | | | | |
| WD (day of the week) : | 1 – 7: Sunday – Saturday | | | | | | | | | | | | | | | |
| SU (summer time) : | Bit to 0 if this parameter is not used | | | | | | | | | | | | | | | |
| iV (validity of received data) : | Bit to 0 if this parameter is not valid or not used | | | | | | | | | | | | | | | |

Command interface

Command interface overview

The command interface allows you to configure the meter by sending specific command requests using Modbus function 16.

Command request

The table below describes a Modbus command request:

| Slave Number | Function Code | Command block | | CRC |
|--------------|---------------|-------------------|--|----------|
| | | Register Address | Command Description | |
| 1 – 247 | 16 | 5250 (up to 5374) | The command is made of a command number and a set of parameters. See the detailed description of each command in the command list. NOTE: All the reserved parameters can be considered as any value, e.g. 0. | Checking |

The command result can be obtained by reading registers 5375 and 5376.

The table below describes the Command result:

| Register Address | Content | Size (Int16) | Data (example) |
|------------------|--|--------------|---------------------|
| 5375 | Requested Command Number | 1 | 2008 (Set Tariff) |
| 5376 | Result Command result codes: <ul style="list-style-type: none"> • 0 = Valid Operation • 3000 = Invalid Command • 3001 = Invalid Parameter • 3002 = Invalid Number of Parameters • 3007 = Operation Not Performed | 1 | 0 (Valid Operation) |

Command list

Set Date/Time

| Command Number | Action (R/W) | Size | Type | Unit | Range | Description |
|----------------|--------------|------|--------|------|-------------|-------------|
| 1003 | W | 1 | UInt16 | — | — | (Reserved) |
| | W | 1 | UInt16 | — | 2000 – 2099 | Year |
| | W | 1 | UInt16 | — | 1 – 12 | Month |
| | W | 1 | UInt16 | — | 1 – 31 | Day |
| | W | 1 | UInt16 | — | 0 – 23 | Hour |
| | W | 1 | UInt16 | — | 0 – 59 | Minute |
| | W | 1 | UInt16 | — | 0 – 59 | Second |
| | W | 1 | UInt16 | — | — | (Reserved) |

Set Wiring

| Command Number | Action (R/W) | Size | Type | Unit | Range | Description |
|----------------|--------------|------|---------|------|--------------------|---|
| 2000 | W | 1 | UInt16 | — | — | (Reserved) |
| | W | 1 | UInt16 | — | 1, 3 | Number of phases |
| | W | 1 | UInt16 | — | 2, 3, 4 | Number of wires |
| | W | 1 | UInt16 | — | 0, 1, 2, 3, 11, 13 | Power System Configuration: 0 = 1PH2W L-N 1 = 1PH2W L-L 2 = 1PH3W L-L-N 3 = 3PH3W 11 = 3PH4W 13 = 1PH4W L-N |
| | W | 1 | UInt16 | Hz | 50, 60 | Nominal Frequency |
| | W | 2 | Float32 | — | — | (Reserved) |
| | W | 2 | Float32 | — | — | (Reserved) |
| | W | 2 | Float32 | — | — | (Reserved) |
| | W | 1 | UInt16 | — | — | (Reserved) |
| | W | 1 | UInt16 | — | — | (Reserved) |
| | W | 2 | Float32 | V | 1000000.0 | VT Primary NOTE: For iEM3250 / iEM3255. Reserved by iEM3150 / iEM3155 / iEM3350 / iEM3355 |
| | W | 1 | UInt16 | V | 100, 110, 115, 120 | VT Secondary NOTE: For iEM3250 / iEM3255. Reserved by iEM3150 / iEM3155 / iEM3350 / iEM3355 |
| | W | 1 | UInt16 | — | 1, 2, 3 | Number of CTs NOTE: For iEM3250 / iEM3255. Reserved by iEM3150 / iEM3155 / iEM3350 / iEM3355 |
| | W | 1 | UInt16 | A | 1 to 32767 | CT Primary NOTE: For iEM3250 / iEM3255. Reserved by iEM3150 / iEM3155 / iEM3350 / iEM3355 |
| | W | 1 | UInt16 | — | — | (Reserved) |
| | W | 1 | UInt16 | — | — | (Reserved) |
| | W | 1 | UInt16 | — | — | (Reserved) |

| Command Number | Action (R/W) | Size | Type | Unit | Range | Description |
|----------------|--------------|------|--------|------|---------|--|
| | W | 1 | UInt16 | — | — | (Reserved) |
| | W | 1 | UInt16 | — | 0, 1, 2 | VT Connection type: 0 = Direct Connect 1 = 3PH3W (2 VTs) 2 = 3PH4W (3 VTs) NOTE: For iEM3250 / iEM3255. Reserved by iEM3150 / iEM3155 / iEM3350 / iEM3355 |

Set Pulse Output (iEM3155 / iEM3255 / iEM3355)

| Command Number | Action (R/W) | Size | Type | Unit | Range | Description |
|----------------|--------------|------|---------|----------------------|---|---|
| 2003 | W | 1 | UInt16 | — | — | (Reserved) |
| | W | 1 | UInt16 | kWh kVARh | 3, 6 | Digital Output Control Mode Status: 3 = kWh 6 = kVARh |
| | W | 1 | UInt16 | — | 0, 1 | Pulse Output enable / disable: 0 = Disable 1 = Enable |
| | W | 2 | Float32 | pulse/kWh | iEM3155 / iEM3355: 1, 10, 20, 100, 200, 1000 iEM3255: 0.01, 0.1, 1, 10, 100, 500 | Pulse constant |
| | W | 1 | UInt16 | — | — | (Reserved) |
| | W | 1 | UInt16 | — | — | (Reserved) |
| | W | 2 | Float32 | — | — | (Reserved) |
| | W | 1 | UInt16 | — | — | (Reserved) |
| | W | 1 | UInt16 | — | — | (Reserved) |
| | W | 2 | Float32 | — | — | (Reserved) |
| 2038 | W | 1 | UInt16 | — | — | (Reserved) |
| | W | 1 | UInt16 | — | — | (Reserved) |
| | W | 1 | UInt16 | ms | 50, 100, 200, 300 | Pulse width |
| 2039 | W | 1 | UInt16 | — | — | (Reserved) |
| | W | 1 | UInt16 | imp/kWh imp/KVARh | 0, 1 | LED energy pulse: 0 = kWh 1 = kVARh |

Set Tariff (iEM3155 / iEM3255 / iEM3355)

| Command Number | Action (R/W) | Size | Type | Unit | Range | Description |
|----------------|--------------|------|--------|------|------------|--|
| 2060 | W | 1 | UInt16 | — | — | (Reserved) |
| | W | 1 | UInt16 | — | 0, 1, 2, 4 | Multi Tariff Mode: 0 = Disable Multi Tariff 1 = Use COM as Tariff Control (maximum 4 tariffs) 2 = Use Digital Input as Tariff Control (2 tariffs) |

| Command Number | Action (R/W) | Size | Type | Unit | Range | Description |
|----------------|--------------|------|--------|------|-------|--|
| | | | | | | 4 = Use Internal Clock as Tariff Control (maximum 4 tariffs) |
| 2008 | W | 1 | UInt16 | — | — | (Reserved) |
| | W | 1 | UInt16 | — | 1 – 4 | Tariff: 1 = T1 2 = T2 3 = T3 4 = T4 NOTE: You can only set the tariff using this method if the Tariff Mode is set to by Communication. |

Set Digital Input as Partial Energy Reset (iEM3155 / iEM3255 / iEM3355)

| Command Number | Action (R/W) | Size | Type | Unit | Range | Description |
|----------------|--------------|------|--------|------|-------|--|
| 6017 | W | 1 | UInt16 | — | — | (Reserved) |
| | W | 1 | UInt16 | — | 0, 1 | Digital Input to Associate: 0 = Disable 1 = Enable |

Input Metering Setup (iEM3155 / iEM3255 / iEM3355)

| Command Number | Action (R/W) | Size | Type | Unit | Range | Description |
|----------------|--------------|------|---------|------|------------------|---|
| 6014 | W | 1 | UInt16 | — | — | (Reserved) |
| | W | 1 | UInt16 | — | 1 | Input Metering Channel |
| | W | 20 | UTF8 | — | String size ≤ 40 | Label |
| | W | 2 | Float32 | — | 1 – 10000 | Pulse Weight |
| | W | 1 | UInt16 | — | — | (Reserved) |
| | W | 1 | UInt16 | — | 0, 1 | Digital Input Association: 0 = Disable 1 = Enable |

Overload Alarm Setup (iEM3155 / iEM3255 / iEM3355)

| Command Number | Action (R/W) | Size | Type | Unit | Range | Description |
|----------------|--------------|------|---------|------|------------|---------------------------|
| 7000 | W | 1 | UInt16 | — | — | (Reserved) |
| | W | 1 | UInt16 | — | 9 | Alarm ID |
| | W | 1 | UInt16 | — | — | (Reserved) |
| | W | 1 | UInt16 | — | — | (Reserved) |
| | W | 1 | UInt16 | — | — | (Reserved) |
| | W | 1 | UInt16 | — | 0, 1 | 0 = Disable 1 = Enable |
| | W | 2 | Float32 | — | 0.0 – 1e10 | Pickup value |
| | W | 2 | UInt32 | — | — | (Reserved) |

| Command Number | Action (R/W) | Size | Type | Unit | Range | Description |
|----------------|--------------|------|---------|------|-------|--|
| | W | 2 | Float32 | — | — | (Reserved) |
| | W | 2 | UInt32 | — | — | (Reserved) |
| | W | 1 | UInt16 | — | — | (Reserved) |
| | W | 4 | UInt16 | — | — | (Reserved) |
| | W | 1 | UInt16 | — | — | (Reserved) |
| | W | 1 | UInt16 | — | — | (Reserved) |
| 20000 | W | 1 | UInt16 | — | — | (Reserved) |
| | W | 2 | Float32 | — | — | (Reserved) |
| | W | 2 | UInt32 | — | — | (Reserved) |
| | W | 1 | Bitmap | — | 0, 1 | Digital Output to Associate: 0 = Unassociated 1 = Associated |
| 20001 | W | 1 | UInt16 | — | — | Acknowledge the Overload Alarm |

Communications Setup

| Command Number | Action (R/W) | Size | Type | Unit | Range | Description |
|----------------|--------------|------|--------|------|---------|--|
| 5000 | W | 1 | UInt16 | — | — | (Reserved) |
| | W | 1 | UInt16 | — | — | (Reserved) |
| | W | 1 | UInt16 | — | — | (Reserved) |
| | W | 1 | UInt16 | — | 1 – 247 | Address |
| | W | 1 | UInt16 | — | 0, 1, 2 | Baud Rate: 0 = 9600 1 = 19200 2 = 38400 |
| | W | 1 | UInt16 | — | 0, 1, 2 | Parity: 0 = Even 1 = Odd 2 = None |
| | W | 1 | UInt16 | — | — | (Reserved) |

Reset Partial Energy Counters

| Command Number | Action (R/W) | Size | Type | Unit | Range | Description |
|----------------|--------------|------|--------|------|-------|--|
| 2020 | W | 1 | UInt16 | — | — | (Reserved) iEM3150 / iEM3250 / iEM3350: Partial Active Energy and Phase Energy registers will be reset iEM3155 / iEM3255 / iEM3355: Partial Active / Reactive Energy, Energy by tariff and Phase Energy registers will be reset. |

Reset Input Metering Counter (iEM3155 / iEM3255 / iEM3355)

| Command Number | Action (R/W) | Size | Type | Unit | Range | Description |
|----------------|--------------|------|--------|------|-------|-------------|
| 2023 | W | 1 | UInt16 | — | — | (Reserved) |

Modbus register list

System

| Address | Register | Action (R/W/WC) | Size | Type | Units | Description |
|--------------------|----------------|-----------------|-------|----------|-------|---|
| 0x001D | 30 | R | 20 | UTF8 | — | Meter Name |
| 0x0031 | 50 | R | 20 | UTF8 | — | Meter Model |
| 0x0045 | 70 | R | 20 | UTF8 | — | Manufacturer |
| 0x0081 | 130 | R | 2 | UInt32 | — | Serial Number |
| 0x0083 | 132 | R | 4 | DATETIME | — | Date of Manufacture |
| 0x0087 | 136 | R | 5 | UTF8 | — | Hardware Revision |
| 0x0664 | 1637 | R | 1 | UInt16 | — | Present Firmware Version (DLF format): X.Y.ZTT |
| 0x0734 – 0x0737 | 1845 – 1848 | R/WC | 1 X 4 | UInt16 | — | Date/Time: Reg. 1845: Year (b6:b0) 0 – 99 (year from 2000 to 2099) Reg. 1846: Month (b11:b8), Weekday (b7:b5), Day (b4:b0) Reg. 1847: Hour (b12:b8), Minute (b5:b0) Reg. 1848: Millisecond |
| 0xAFC7 | 45000 | R | 1 | Bitmap | — | Diagnostics error status 0 = Inactive 1 = Active Bit0 = Code 101 Bit1 = Code 102 Bit2 = Code 201 Bit3 = Code 202 Bit4 = Code 203 Bit5 = Code 204 Bit6 = Code 205 Bit7 = Code 206 Bit8 = Code 207 |

Meter Setup and Status

| Address | Register | Action (R/W/WC) | Size | Type | Units | Description |
|---------|----------|-----------------|------|--------|--------|--|
| 0x07D3 | 2004 | R | 2 | UInt32 | Second | Meter Operation Timer NOTE: Not applicable for iEM3150 / iEM3250 / iEM3350 |
| 0x07DD | 2014 | R | 1 | UInt16 | — | Number of Phases |
| 0x07DE | 2015 | R | 1 | UInt16 | — | Number of Wires |
| 0x07DF | 2016 | R/WC | 1 | UInt16 | — | Power System: 0 = 1PH2W L-N |

| Address | Register | Action (R/W/WC) | Size | Type | Units | Description |
|---------|----------|-----------------|------|---------|-------|--|
| | | | | | | 1 = 1PH2W L-L 2 = 1PH3W L-L with N 3 = 3PH3W 11 = 3PH4W 13 = 1PH4W multi L with N |
| 0x07E0 | 2017 | R/WC | 1 | UInt16 | Hz | Nominal Frequency |
| 0x07E8 | 2025 | R | 1 | UInt16 | — | Number VTs NOTE: Not applicable for iEM3150 / iEM3155 / iEM3350 / iEM3355 |
| 0x07E9 | 2026 | R/WC | 2 | Float32 | V | VT Primary NOTE: Not applicable for iEM3150 / iEM3155 / iEM3350 / iEM3355 |
| 0x07EB | 2028 | R/WC | 1 | UInt16 | V | VT Secondary NOTE: Not applicable for iEM3150 / iEM3155 / iEM3350 / iEM3355 |
| 0x07EC | 2029 | R/WC | 1 | UInt16 | — | Number CTs NOTE: Not applicable for iEM3150 / iEM3155 / iEM3350 / iEM3355 |
| 0x07ED | 2030 | R/WC | 1 | UInt16 | A | CT Primary NOTE: Not applicable for iEM3150 / iEM3155 / iEM3350 / iEM3355 |
| 0x07EE | 2031 | R/WC | 1 | UInt16 | A | CT Secondary NOTE: Not applicable for iEM3150 / iEM3155 / iEM3350 / iEM3355 |
| 0x07F3 | 2036 | R/WC | 1 | UInt16 | — | VT Connection Type: 0 = Direct Connect 1 = 3PH3W (2 VTs) 2 = 3PH4W (3 VTs) NOTE: Not applicable for iEM3150 / iEM3155 / iEM3350 / iEM3355 |

Energy Pulse Output Setup (iEM3155 / iEM3255 / iEM3355)

| Address | Register | Action (R/W/WC) | Size | Type | Units | Description |
|---------|----------|-----------------|------|---------|-------------|--|
| 0x0850 | 2129 | R/WC | 1 | UInt16 | Millisecond | Energy Pulse Duration |
| 0x0852 | 2131 | R/WC | 1 | UInt16 | — | Digital Output Association 0 = Disable 1 = DO1 enable for active energy pulse output |
| 0x0853 | 2132 | R/WC | 2 | Float32 | pulse/kWh | Pulse Weight |

Command Interface

| Address | Register | Action (R/W/WC) | Size | Type | Units | Description |
|---------|----------|-----------------|------|--------|-------|-----------------------|
| 0x1481 | 5250 | R/W | 1 | UInt16 | — | Requested Command |
| 0x1483 | 5252 | R/W | 1 | UInt16 | — | Command Parameter 001 |
| 0x14FD | 5374 | R/W | 1 | UInt16 | — | Command Parameter 123 |
| 0x14FE | 5375 | R | 1 | UInt16 | — | Command Status |

| Address | Register | Action (R/W/WC) | Size | Type | Units | Description |
|---------|----------|-----------------|------|--------|-------|---|
| 0x14FF | 5376 | R | 1 | UInt16 | — | Command Result codes: 0 = Valid Operation 3000 = Invalid Command 3001 = Invalid Parameter 3002 = Invalid Number of Parameters 3007 = Operation Not Performed |
| 0x1500 | 5377 | R/W | 1 | UInt16 | — | Command Data 001 |
| 0x157A | 5499 | R | 1 | UInt16 | — | Command Data 123 |

Communication

| Address | Register | Action (R/W/WC) | Size | Type | Units | Description |
|---------|----------|-----------------|------|--------|-------|--|
| 0x1963 | 6500 | R | 1 | UInt16 | — | Protocol 0 = Modbus |
| 0x1964 | 6501 | R/WC | 1 | UInt16 | — | Address |
| 0x1965 | 6502 | R/WC | 1 | UInt16 | — | Baud Rate: 0 = 9600 1 = 19200 2 = 38400 |
| 0x1966 | 6503 | R/WC | 1 | UInt16 | — | Parity: 0 = Even 1 = Odd 2 = None NOTE: Number of stop bits = 1 |

Input Metering Setup (iEM3155 / iEM3255 / iEM3355)

| Address | Register | Action (R/W/WC) | Size | Type | Units | Description |
|---------|----------|-----------------|------|---------|------------|---|
| 0x1B77 | 7032 | R/WC | 20 | UTF8 | — | Label |
| 0x1B8B | 7052 | R/WC | 2 | Float32 | pulse/unit | Pulse Constant |
| 0x1B8E | 7055 | R/WC | 1 | UInt16 | — | Digital Input Association: 0 = Disable for input metering 1 = Enable for input metering |

Digital Input (iEM3155 / iEM3255 / iEM3355)

| Address | Register | Action (R/W/WC) | Size | Type | Units | Description |
|---------|----------|-----------------|------|--------|-------|--|
| 0x1C69 | 7274 | R | 1 | UInt16 | — | Digital Input Control Mode: 0 = Normal (Input Status) 2 = Multi Tariff Control 3 = Input Metering 5 = All Energy Reset |
| 0x22C8 | 8905 | R | 2 | Bitmap | — | Digital Input Status (only Bit 1 is used): Bit 1 = 0, relay open Bit 1 = 1, relay closed |

Digital Output (iEM3155 / iEM3255 / iEM3355)

| Address | Register | Action (R/W/WC) | Size | Type | Units | Description |
|---------|----------|-----------------|------|--------|-------|--|
| 0x25C8 | 9673 | R | 1 | UInt16 | — | Digital Output Control Mode Status: 2 = Alarm 3 = Pulse (kWh) 6 = Pulse (kVARh) 0xFFFF = Disable |

PF firmware updates (iEM3155 / iEM3255 / iEM3355)

Addition to PF Registers: Values ranging from +1 to -1

| Address | Register | Action (R/W/WC) | Size | Type | Units | Description |
|---------|----------|-----------------|------|---------|-------|-----------------------------|
| 0x0C77 | 3192 | R | 2 | Float32 | — | Power Factor Total IEC |
| 0x0C79 | 3194 | R | 2 | Float32 | — | Power Factor Total Lead Lag |
| 0x0C7B | 3196 | R | 1 | UInt16 | — | Power Factor Total IEC |
| 0x0C7C | 3197 | R | 1 | UInt16 | — | Power Factor Total Lead Lag |

1PH4W Multi LN updates (iEM3155 / iEM3255 / iEM3355)

Addition of each phase reactive energy import register

| Address | Register | Action (R/W/WC) | Size | Type | Units | Description |
|---------|----------|-----------------|------|---------|-------|-----------------------------------|
| 0xB047 | 45128 | R | 2 | Float32 | kVARh | Reactive Energy Delivered Phase A |
| 0xB049 | 45130 | R | 2 | Float32 | kVARh | Reactive Energy Delivered Phase B |
| 0xB04B | 45132 | R | 2 | Float32 | kVARh | Reactive Energy Delivered Phase C |

You can access each phase reactive energy import values using INT64 or Float 32 register format.

Addition of each phase name register

| Address | Register | Action (R/W/WC) | Size | Type | Units | Description | Default value |
|---------|----------|-----------------|------|------|-------|--------------|---------------|
| 0xDEA7 | 57000 | R | 5 | UTF8 | — | Phase 1 Name | PH1 Eng Impt |
| 0xDEAC | 57005 | R | 5 | UTF8 | — | Phase 2 Name | PH2 Eng Impt |
| 0xDEB1 | 57010 | R | 5 | UTF8 | — | Phase 3 Name | PH3 Eng Impt |

Addition of one command to set the each phase name

| Command Number | Action (R/W/WC) | Size | Type | Units | Range | Description |
|----------------|-----------------|------|--------|-------|------------------|--------------------|
| 6018 | W | 1 | UInt16 | — | — | (Reserved) |
| | W | 5 | UTF8 | — | String size ≤ 10 | Phase 1 name Label |
| | W | 5 | UTF8 | — | String size ≤ 10 | Phase 2 name Label |
| | W | 5 | UTF8 | — | String size ≤ 10 | Phase 3 name Label |

Addition to display: Each phase active/reactive values are added to HMI

NOTE: When the wiring configuration is 1PH4W Multi LN, the partial energy reset through Digital Input or Command is not possible.

Meter Data

Current, voltage, power, power factor and frequency

| Address | Register | Action (R/W/WC) | Size | Type | Units | Description |
|----------------|----------|-----------------|------|---------|-------|----------------------|
| Current | | | | | | |
| 0x0BB7 | 3000 | R | 2 | Float32 | A | I1: phase 1 current |
| 0x0BB9 | 3002 | R | 2 | Float32 | A | I2: phase 2 current |
| 0x0BBB | 3004 | R | 2 | Float32 | A | I3: phase 3 current |
| 0x0BC1 | 3010 | R | 2 | Float32 | A | Current Avg |
| Voltage | | | | | | |
| 0x0BCB | 3020 | R | 2 | Float32 | V | Voltage L1-L2 |
| 0x0BCD | 3022 | R | 2 | Float32 | V | Voltage L2-L3 |
| 0x0BCF | 3024 | R | 2 | Float32 | V | Voltage L3-L1 |
| 0x0BD1 | 3026 | R | 2 | Float32 | V | Voltage L-L Avg |
| 0x0BD3 | 3028 | R | 2 | Float32 | V | Voltage L1-N |
| 0x0BD5 | 3030 | R | 2 | Float32 | V | Voltage L2-N |
| 0x0BD7 | 3032 | R | 2 | Float32 | V | Voltage L3-N |
| 0x0BDB | 3036 | R | 2 | Float32 | V | Voltage L-N Avg |
| Power | | | | | | |
| 0x0BED | 3054 | R | 2 | Float32 | kW | Active Power Phase 1 |
| 0x0BEF | 3056 | R | 2 | Float32 | kW | Active Power Phase 2 |

| Address | Register | Action (R/W/WC) | Size | Type | Units | Description |
|---------------------|----------|-----------------|------|---------|-------|--|
| 0x0BF1 | 3058 | R | 2 | Float32 | kW | Active Power Phase 3 |
| 0x0BF3 | 3060 | R | 2 | Float32 | kW | Total Active Power |
| 0x0BFB | 3068 | R | 2 | Float32 | kVAR | Total Reactive Power NOTE: Not applicable for iEM3150 / iEM3250 / iEM3350 |
| 0x0C03 | 3076 | R | 2 | Float32 | kVA | Total Apparent Power NOTE: Not applicable for iEM3150 / iEM3250 / iEM3350 |
| Power Factor | | | | | | |
| 0x0C0B | 3084 | R | 2 | Float32 | — | Total Power Factor: -1 < PF < 0 = Quad 2, active power negative, capacitive -2 < PF < -1 = Quad 3, active power negative, inductive 0 < PF < 1 = Quad 1, active power positive, inductive 1 < PF < 2 = Quad 4, active power positive, capacitive |
| Frequency | | | | | | |
| 0x0C25 | 3110 | R | 2 | Float32 | Hz | Frequency |

Energy, energy by tariff and input metering

Most energy values are available in both signed 64-bit integer and 32-bit floating point format.

The energy and energy by tariff measurements listed below are preserved through power failures.

| Energy reset and active tariff information | | | | | | |
|--|----------|-----------------|------|-----------|-------|---|
| Address | Register | Action (R/W/WC) | Size | Type | Units | Description |
| 0x0CB3 | 3252 | R | 4 | DATE TIME | — | Energy Reset Date and Time |
| 0x0DE1 | 3554 | R | 4 | DATE TIME | — | Input Metering Accumulation Reset Date and Time NOTE: Not applicable for iEM3150 / iEM3250 / iEM3350 |
| 0x105E | 4191 | R/WC | 1 | UInt16 | — | Multi Tariffs Energy Active Rate: 0: Multi Tariff disabled 1 to 4: rate A to rate D NOTE: You can only set the tariff using this method if the Tariff Mode is set to by Communication. NOTE: Not applicable for iEM3150 / iEM3250 / iEM3350 |

| Energy values – 64-bit integer | | | | | | |
|---------------------------------------|----------|-----------------|------|-------|-------|---|
| Address | Register | Action (R/W/WC) | Size | Type | Units | Description |
| Total Energy (cannot be reset) | | | | | | |
| 0x0C83 | 3204 | R | 4 | Int64 | Wh | Total Active Energy Import |
| 0x0C87 | 3208 | R | 4 | Int64 | Wh | Total Active Energy Export NOTE: Not applicable for iEM3150 / iEM3250 / iEM3350 |

| Energy values – 64-bit integer | | | | | | |
|--|----------|-----------------|------|-------|-------|---|
| Address | Register | Action (R/W/WC) | Size | Type | Units | Description |
| 0x0C93 | 3220 | R | 4 | Int64 | VARh | Total Reactive Energy Import NOTE: Not applicable for iEM3150 / iEM3250 / iEM3350 |
| 0x0C97 | 3224 | R | 4 | Int64 | VARh | Total Reactive Energy Export NOTE: Not applicable for iEM3150 / iEM3250 / iEM3350 |
| Partial Energy | | | | | | |
| 0x0CB7 | 3256 | R | 4 | Int64 | Wh | Partial Active Energy Import |
| 0x0CC7 | 3272 | R | 4 | Int64 | VARh | Partial Reactive Energy Import NOTE: Not applicable for iEM3150 / iEM3250 / iEM3350 |
| Phase Energy | | | | | | |
| 0x0DBD | 3518 | R | 4 | Int64 | Wh | Active Energy Import Phase 1 |
| 0x0DC1 | 3522 | R | 4 | Int64 | Wh | Active Energy Import Phase 2 |
| 0x0DC5 | 3526 | R | 4 | Int64 | Wh | Active Energy Import Phase 3 |
| Input Metering Counter | | | | | | |
| 0x0DE5 | 3558 | R | 4 | Int64 | Unit | Input Metering Accumulation NOTE: Not applicable for iEM3150 / iEM3250 / iEM3350 |
| Energy by Tariff (iEM3155 / iEM3255 / iEM3355 only) | | | | | | |
| 0x1063 | 4196 | R | 4 | Int64 | Wh | Rate A Active Energy Import |
| 0x1067 | 4200 | R | 4 | Int64 | Wh | Rate B Active Energy Import |
| 0x106B | 4204 | R | 4 | Int64 | Wh | Rate C Active Energy Import |
| 0x106F | 4208 | R | 4 | Int64 | Wh | Rate D Active Energy Import |

| Energy values – 32-bit floating point | | | | | | |
|---------------------------------------|----------|-----------------|------|---------|-------|---|
| Address | Register | Action (R/W/WC) | Size | Type | Units | Description |
| Total Energy (cannot be reset) | | | | | | |
| 0xB02B | 45100 | R | 2 | Float32 | kWh | Total Active Energy Import |
| 0xB02D | 45102 | R | 2 | Float32 | kWh | Total Active Energy Export NOTE: Not applicable for iEM3150 / iEM3250 / iEM3350 |
| 0xB02F | 45104 | R | 2 | Float32 | kVARh | Total Reactive Energy Import NOTE: Not applicable for iEM3150 / iEM3250 / iEM3350 |
| 0xB031 | 45106 | R | 2 | Float32 | kVARh | Total Reactive Energy Export NOTE: Not applicable for iEM3150 / iEM3250 / iEM3350 |
| Partial Energy | | | | | | |
| 0xB033 | 45108 | R | 2 | Float32 | kWh | Partial Active Energy Import |
| 0xB035 | 45110 | R | 2 | Float32 | kVARh | Partial Reactive Energy Import NOTE: Not applicable for iEM3150 / iEM3250 / iEM3350 |
| Phase Energy | | | | | | |
| 0xB037 | 45112 | R | 2 | Float32 | kWh | Active Energy Import Phase 1 |
| 0xB039 | 45114 | R | 2 | Float32 | kWh | Active Energy Import Phase 2 |

| Energy values – 32-bit floating point | | | | | | |
|--|----------|-----------------|------|---------|-------|--|
| Address | Register | Action (R/W/WC) | Size | Type | Units | Description |
| 0xB03B | 45116 | R | 2 | Float32 | kWh | Active Energy Import Phase 3 |
| Input Metering Counter | | | | | | |
| 0xB03D | 45118 | R | 2 | Float32 | Unit | Input Metering Accumulation NOTE: Not applicable for iEM3150 / iEM3250 / iEM3350 |
| Energy by Tariff (iEM3155 / iEM3255 / iEM3355 only) | | | | | | |
| 0xB03F | 45120 | R | 2 | Float32 | kWh | Rate A Active Energy Import |
| 0xB041 | 45122 | R | 2 | Float32 | kWh | Rate B Active Energy Import |
| 0xB043 | 45124 | R | 2 | Float32 | kWh | Rate C Active Energy Import |
| 0xB045 | 45126 | R | 2 | Float32 | kWh | Rate D Active Energy Import |

Overload Alarm (iEM3155 / iEM3255 / iEM3355)

| Address | Register | Action (R/W/WC) | Size | Type | Units | Description |
|---------|----------|-----------------|------|----------|-------|--|
| 0xAFC8 | 45001 | R/WC | 1 | Bitmap | — | Overload Alarm Setup: 0x0000 = Disabled 0x0100 = Enabled |
| 0xAFC9 | 45002 | R/WC | 2 | Float32 | kW | Pickup Setpoint |
| 0xAFCB | 45004 | R/WC | 1 | Bitmap | — | Digital Output to Associate: 0x0000 = Digital Output unassociated to overload alarm 0x0100 = Digital Output associated to overload alarm |
| 0xAFCC | 45005 | R | 1 | Bitmap | — | Activated Status: 0x0000 = Alarm is inactive 0x0100 = Alarm is active |
| 0xAFCD | 45006 | R | 1 | Bitmap | — | Unacknowledged Status: 0x0000 = Historic alarm is acknowledged by the user 0x0100 = Historic alarm is unacknowledged by the user |
| 0xAFCE | 45007 | R | 4 | DATETIME | — | Last Alarm - Time Stamp |
| 0xAFD2 | 45011 | R | 2 | Float32 | kW | Last Alarm - Value |

Read Device Identification

The meters supports the Read Device Identification function with the mandatory objects Vendor Name, Product Code, Firmware Revision, Vendor URL, Product Range, Product Model and User Application Name.

| Object ID | Name / Description | Length | Value | Note |
|-----------|--------------------|--------|----------------------|--|
| 0x00 | Vendor Name | 20 | Schneider Electric | — |
| 0x01 | Product Code | 20 | Commercial reference | The ProductCode value is identical to the catalog number of each device Ex: A9MEM3x55 |
| 0x02 | Firmware Revision | 06 | XXX.YYY.ZZZ | — |

| Object ID | Name / Description | Length | Value | Note |
|-----------|-----------------------|--------|-------------------|-------------------------|
| 0x03 | Vendor URL | 20 | www.se.com | — |
| 0x04 | Product Range | 20 | iEM3000 | — |
| 0x05 | Product Model | 20 | Product Model | Ex: A9MEM3x55 |
| 0x06 | User Application Name | 20 | User configurable | Default = Product model |

The Read Device ID codes 01, 02 and 04 are supported:

- 01 = request to get basic device identification (stream access)
- 02 = request to get regular device identification (stream access)
- 04 = request to get one specific identification object (individual access)

The Modbus request and response are compliant with the Modbus Application Protocol Specification.

Communications via LonWorks

LonWorks communications overview

LonWorks communications is available on iEM3175 / iEM3275 / iEM3375 meter models.

The information in this section assumes that you have an advanced understanding of LonWorks communications, your communications network and the power system that your device is connected to.

LonWorks communication implementation

External interface file (XIF)

The variables and configuration properties for the meter are documented in the external interface file (XIF). The XIF file is loaded onto the meter where your LNS (LonWorks Network Services) software can download it. You can also download the XIF file from www.se.com if you need to manually add the XIF file to your software.

The LonMaker plug-ins

The plug-ins allow you to configure the meter and view meter data in Echelon LonMaker.

LED indicators for LonWorks meters

The LonWorks meters have two LonWorks status LEDs: the red service LED and the green communications LED.

Red service LED

This LED provides the status of LonWorks operations.

| LED state | Description |
|---------------------|---|
| The LED is off | The meter is configured. It may be online or offline. |
| The LED is flashing | The meter is not configured but has an application. |
| The LED is on | <ul style="list-style-type: none"> The meter is not configured and without an application, or There is a defective internal memory issue. |

Green communications LED

This LED provides the status of the meter's communications with the network.

| LED state | Description |
|---------------------|------------------------------|
| The LED is off | Communication is not active. |
| The LED is flashing | Communication is active. |

Location of the service pin and Neuron ID

The service pin is located on the front panel. Press this when requested by your LNS software in order to identify the meter to your LonWorks network.

You can also find the Neuron ID on the meter label if you need to manually enter it into your LNS software.

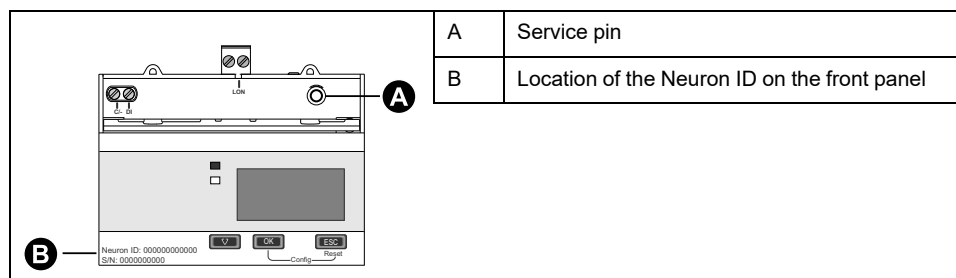

Standard network variable types and configuration properties for reading data

The following sections outline the Standard Network Variable Types (SNVTs), the Standard Configuration Property Types (SCPTs), and User Configuration Property Types (UCPTs) that you can access to read data from the meter.

General variables

| Network variable label | Type | Description |
|------------------------|----------------|-------------------------------------|
| nviRequest | SCPTpartNumber | For LonWorks internal communication |
| nvoStatus | SCPToemType | For LonWorks internal communication |

System variables

| Network variable label | Type | Description |
|------------------------|----------------------------------|--|
| nvoFileDirectory | SNVT_address | Configuration parameter file directory address (LonMark) |
| nvoResponse | SNVT_count | Command result (LonMark) |
| nvoErrors | SNVT_state | Device error status Error bitmap: each bit of the bitmap provides error information about the device. If value of the bit = 1, that error is active. Bit0 = Code 101: EEPROM error Bit1 = Code 102: No calibration table Bit2 = Code 201: mismatch between frequency settings and frequency measurements Bit3 = Code 202: mismatch between wiring settings and wiring inputs Bit4 = Code 203: phase sequence reversed Bit5 = Not used Bit6 = Code 205: Date and time have been reset due to a power failure Bit7 = Not used Bit8 = Code 207: Abnormal internal clock function Bit9 = Internal data bus communications error Bit10 – 15: Not used |
| nciMeterModel | SNVT_str_asc (SCPTpartNumber) | Device model, stored as an ASCII string (for example, iEM3275) |
| nciMeterManf | SNVT_str_asc | Manufacturer name (Schneider Electric) |

| Network variable label | Type | Description |
|------------------------|------------------------------------|--|
| | (SCPToemType) | |
| nciSerialNumber | SNVT_str_asc (SCPTserialNumber) | Device serial number |
| nciManfDateTime | SNVT_time_stamp (SCPTmanfDate) | Date of manufacture |
| nciDevMajVer | SCPTdevMajVer | LonWorks firmware major version (for example, 2.xx) This variable functions with nciDevMinVer to provide the device's LonWorks firmware version |
| nciDevMinVer | SCPTdevMinVer | LonWorks firmware minor version (for example, x.34) This variable functions with nciDevMajVer to provide the device's LonWorks firmware version |
| nciMeterVersion | SNVT_str_asc (UCPTMeterVersion) | Device firmware version, stored as an ASCII text string |

Energy and energy by tariff measurements

Most energy values are available in both signed 32-bit integer and floating point format. The SNVT is appended with `_l` for 32-bit integer values and `_f` for floating point values.

For example, the SNVTs for total active energy import are as follows:

- 32-bit integer: SNVT_elec_kwh_l
- Floating point: SNVT_elec_whr_f

The energy and energy by tariff measurements listed below are preserved through power failures.

| Network variable label | Type | Description |
|------------------------|-----------------|--|
| nvoTotkWhImp | SNVT_elec_kwh_l | Total active energy import |
| nvoTotkWhExp | SNVT_elec_kwh_l | Total active energy export |
| nvoTotkVARhImp | SNVT_elec_kwh_l | Total reactive energy import |
| nvoTotkVARhExp | SNVT_elec_kwh_l | Total reactive energy export |
| nvoTotWhImp | SNVT_elec_whr_f | Total active energy import |
| nvoTotWhExp | SNVT_elec_whr_f | Total active energy export |
| nvoTotVARhImp | SNVT_elec_whr_f | Total reactive energy import |
| nvoTotVARhExp | SNVT_elec_whr_f | Total reactive energy export |
| nvoPartialkWh | SNVT_elec_kwh_l | Partial active energy import |
| nvoPartialkVARh | SNVT_elec_kwh_l | Partial reactive energy import |
| nvoPartialWh | SNVT_elec_whr_f | Partial active energy import |
| nvoPartialVARh | SNVT_elec_whr_f | Partial reactive energy import |
| nvoPh1kWh | SNVT_elec_kwh_l | Active energy import phase 1 |
| nvoPh2kWh | SNVT_elec_kwh_l | Active energy import phase 2 |
| nvoPh3kWh | SNVT_elec_kwh_l | Active energy import phase 3 |
| nvoPh1Wh | SNVT_elec_whr_f | Active energy import phase 1 |
| nvoPh2Wh | SNVT_elec_whr_f | Active energy import phase 2 |
| nvoPh3Wh | SNVT_elec_whr_f | Active energy import phase 3 |
| nvoTariffActRate | SNVT_count | Active tariff: 0 = Multi Tariff feature is disabled 1 = rate A (tariff 1) active |

| Network variable label | Type | Description |
|------------------------|-----------------|--|
| | | 2 = rate B (tariff 2) active 3 = rate C (tariff 3) active 4 = rate D (tariff 4) active |
| nvoTariffAkWh | SNVT_elec_kwh_l | Rate A (tariff 1) active energy import |
| nvoTariffBkWh | SNVT_elec_kwh_l | Rate B (tariff 2) active energy import |
| nvoTariffCkWh | SNVT_elec_kwh_l | Rate C (tariff 3) active energy import |
| nvoTariffDkWh | SNVT_elec_kwh_l | Rate D (tariff 4) active energy import |
| nvoTariffAWh | SNVT_elec_whr_f | Rate A (tariff 1) active energy import |
| nvoTariffBWh | SNVT_elec_whr_f | Rate B (tariff 2) active energy import |
| nvoTariffCWh | SNVT_elec_whr_f | Rate C (tariff 3) active energy import |
| nvoTariffDWh | SNVT_elec_whr_f | Rate D (tariff 4) active energy import |
| nvoInMeterAcc | SNVT_count_f | Input metering accumulation |
| nvoRstEnergyDT | SNVT_time_stamp | Date and time of last energy reset |

Instantaneous (RMS) measurements

| Network variable label | Type | Description |
|------------------------|------------------|---------------------------------|
| nvoActPowerPh1 | SNVT_power_f | Active power Phase 1 |
| nvoActPowerPh2 | SNVT_power_f | Active power Phase 2 |
| nvoActPowerPh3 | SNVT_power_f | Active power Phase 3 |
| nvoActPowerSum | SNVT_power_f | Total active power |
| nvoRctPowerSum | SNVT_power_f | Total reactive power |
| nvoAppPowerSum | SNVT_power_f | Total apparent power |
| nvoVoltsL1N | SNVT_volt_f | Voltage L1-N |
| nvoVoltsL2N | SNVT_volt_f | Voltage L2-N |
| nvoVoltsL3N | SNVT_volt_f | Voltage L3-N |
| nvoVoltsLLNAvg | SNVT_volt_f | Average voltage line-to-neutral |
| nvoVoltsL1L2 | SNVT_volt_f | Voltage L1-L2 |
| nvoVoltsL2L3 | SNVT_volt_f | Voltage L2-L3 |
| nvoVoltsL3L1 | SNVT_volt_f | Voltage L3-L1 |
| nvoVoltsLLAvg | SNVT_volt_f | Average voltage line-to-line |
| nvoCurrentPh1 | SNVT_amp_f | Phase 1 current |
| nvoCurrentPh2 | SNVT_amp_f | Phase 2 current |
| nvoCurrentPh3 | SNVT_amp_f | Phase 3 current |
| nvoCurrentAvg | SNVT_amp_f | Average current |
| nvoAvgPwrFactor | SNVT_count_inc_f | Total power factor |
| nvoFrequency | SNVT_freq_f | Frequency |

Meter status information

You can read the following network variables to obtain configuration and status information about the meter. For information on configuring the meter, see the sections on meter configuration properties and the LonWorks plug-in.

| Network variable label | SNVT / UCPT type | Description |
|---|------------------|---|
| Basic information and meter configuration | | |
| nvoDateTime | SNVT_time_stamp | Meter date and time (DD/MM/YYYY hh:mm:ss) |
| nvoOpTimer | SNVT_count_32 | Meter operation timer: the time in seconds since the meter was last powered up |
| System configuration information | | |
| nciSystemType | SNVT_count | Power system configuration: 0 = 1PH2W L-N 1 = 1PH2W L-L 2 = 1PH3W L-L with N 3 = 3PH3W 11 = 3PH4W 13 = 1PH4 wire multi L-N |
| nciWireNum | SNVT_count | Number of wires 2, 3, 4 |
| nciPhaseNum | SNVT_count | Number of phases 1, 3 |
| nciCtNum | SNVT_count | Number of CTs 1, 2, 3 NOTE: Applicable only for iEM3275 |
| nciVtNum | SNVT_count | Number of VTs 0 – 10 NOTE: Applicable only for iEM3275 |
| nciVtPrimary | SNVT_count_32 | VT Primary NOTE: Applicable only for iEM3275 |
| nciVTSecondary | SNVT_count | VT Secondary NOTE: Applicable only for iEM3275 |
| nciCtPrimary | SNVT_count | CT Primary NOTE: Applicable only for iEM3275 |
| nciCtSecondary | SNVT_count | CT Secondary NOTE: Applicable only for iEM3275 |
| nciVtConnType | SNVT_count | VT connection type: 0 = Direct connection, no VTs 1 = 3PH3W (2VTs) 2 = 3PH4W (3VTs) |
| nciNominalFreq | SNVT_freq_hz | System frequency 50, 60 |
| Digital input configuration and status information | | |
| nciDICtrMode | SNVT_count | Digital input control mode: 0 = Normal (input status) 2 = Multi Tariff control 3 = Input metering 5 = All partial energy reset (configure to reset all partial energy logs) |
| nciDIPulseConst | SNVT_count_32 | Pulse constant (pulses/unit) |
| nvoDIStatus | SNVT_count | Digital input status (only Bit 1 is used): 0 = relay open 1 = relay closed NOTE: The information provided by this variable only applies if the digital input control mode is set to Input Status. |
| Alarm status | | |
| nvoAlmStatus | SNVT_count | Alarm status (only Bit 1 is used): 0 = Alarm is inactive |

| Network variable label | SNVT / UCPT type | Description |
|------------------------|------------------|--|
| | | 1 = Alarm is active |
| nvoAlmUnAckState | SNVT_count | Acknowledgement status (only Bit 1 is used): 0 = historic alarm is acknowledged by the user 1 = historic alarm is unacknowledged by the user |
| nvoAlmLastTime | SNVT_time_stamp | Timestamp of last alarm (DD/MM/YYYY hh:mm:ss) |
| nvoAlmLastValue | SNVT_power_f | Value at last alarm |
| nciAlmEnable | SNVT_count | Overload alarm configuration: 0 = disabled 1 = enabled |
| nciAlmPkUpSetPt | SNVT_power_f | Active power alarm pickup setpoint in kW |

Resets

| Network variable label | Type | Description | Action |
|------------------------|-------------|--|-------------------------------------|
| nciRstPartEnergy | SNVT_switch | Resets all partial energy accumulators to 0: Partial active energy import (nvoPartialkWh, nvoPartialWh) Partial reactive energy import (nvoPartialkVARh, nvoPartialVARh) Rate A active energy import (nvoTariffAkWh, nvoTariffAWh) Rate B active energy import (nvoTariffBkWh, nvoTariffBWh) Rate C active energy import (nvoTariffCkWh, nvoTariffCWh) Rate D active energy import (nvoTariffDkWh, nvoTariffDWh) Active energy import phase 1 (nvoPh1kWh, nvoPh1Wh) Active energy import phase 2 (nvoPh2kWh, nvoPh2Wh) Active energy import phase 3 (nvoPh3kWh, nvoPh3Wh) | To reset, set the state field to 1. |
| nciRstInMeterAcc | SNVT_switch | Resets input metering accumulation (nvoInMeterAcc) to 0 | To reset, set the state field to 1. |

Meter configuration properties

You can configure the meter using the configuration properties listed in this section. However, it is recommended that you use the Echelon LonMaker plug-in if you are configuring the meter using LonWorks communications.

NOTE: If Com. Protection is enabled, you may receive an error response when you try to configure the meter over communications.

Date/time setup

| Function profile | UCPT | Struct Members | Range / Options |
|------------------|--------------|----------------|-----------------|
| nciCfgDateTime | UCPTDateTime | year | 2000 – 2099 |
| | | month | 1 – 12 |
| | | day | 1 – 31 |
| | | hour | 0 – 23 |
| | | minute | 0 – 59 |

| Function profile | UCPT | Struct Members | Range / Options |
|------------------|------|----------------|-----------------|
| | | second | 0 – 59 |

Basic setup

| Function profile | UCPT | Struct Members | Range / Options | Description |
|------------------|------------|----------------|--------------------|--|
| nciCfgWiring | UCPTWiring | SystemType | 0, 1, 2, 3, 11, 13 | Power system configuration: 0 = 1PH2W L-N 1 = 1PH2W L-L 2 = 1PH3W L-L with N 3 = 3PH3W 11 = 3PH4W 13 = 1PH4 wire multi L with N |
| | | NominFreq | 50, 60 | Nominal frequency in Hz |
| | | VtPrimary | 0 to 1000000.0 | VT primary The minimum value for VtPrimary must be equal to or greater than the value set for VtSecondary NOTE: Applicable only for iEM3275 |
| | | VtSecondary | 100, 110, 115, 120 | VT secondary NOTE: Applicable only for iEM3275 |
| | | CtNum | 1, 2, 3 | Number of CTs NOTE: Applicable only for iEM3275 |
| | | CtPrimary | 1 to 32767 | CT primary NOTE: Applicable only for iEM3275 |
| | | CtSecondary | 1, 5 | CT secondary NOTE: Applicable only for iEM3275 |
| | | VtConnType | 0, 1, 2 | VT connection type: 0 = Direct connection 1 = 3PH3W (2VTs) 2 = 3PH4W (3VTs) NOTE: Applicable only for iEM3275 |

Digital input setup

| Function profile | UCPT | Struct Members | Range / Options | Description |
|------------------|------------------|----------------|-----------------|--|
| nciCfgDigitInpt | UCPTDigitalInput | — | 0, 1 | Associates the digital input to reset partial energy data: 0 = Digital input is not associated with the partial energy reset. 1 = Digital input is associated with the partial energy reset. Setting this property to 1 also updates nciDICTrlMode (UCPTDiCtrlMode) to All Energy Reset |

Input metering setup

| Function profile | UCPT | Struct Members | Range / Options | Description |
|------------------|-------------------|--------------------|-----------------|--|
| nciCfgInptMetAcc | UCPTInputMetering | PulseWeight | 1 – 10000 | Sets the pulse weight (1 – 10000 ms) Setting this property also sets nciDIPulseConst (UCPTDiPulseConst) to the same value. |
| | | DigitalAssociation | 0, 1 | Associates the digital input with input metering: 0 = Digital input is not associated with input metering 1 = The digital input is associated with input metering Setting this property to 1 also updates nciDICtrlMode (UCPTDiCtrlMode) to Input Metering. |

Overload alarm setup

| Function profile | UCPT | Struct Members | Range / Options | Description |
|------------------|--------------------|----------------|-----------------|--|
| nciCfgOvLoadAlm | UCPTOverLoadAlarm | AlmEnable | 0, 1 | Enable or disable the overload alarm: 0 = Disabled 1 = Enabled |
| | | PkUpSetpoint | 1 – 9999999 | The pickup value for the overload alarm |
| nciCfgOvLoadAck | UCPTOverLoadAlmAck | — | 0, 1 | Acknowledgement status (only Bit 1 is used): 0 = historic alarm is acknowledged by the user 1 = historic alarm is unacknowledged by the user |

Multi Tariff setup

| Function profile | UCPT | Struct Members | Range / Options | Description |
|------------------|------------------|----------------|-----------------|--|
| nciCfgCommTariff | UCPTTariffMode | — | 0, 1 | Set Multi Tariff control mode to Disabled or by Communication 0 = Disabled 1 = by Communication NOTE: To configure the Multi Tariff feature to be controlled by the digital input or device clock, use the HMI. |
| nciCfgTariffSel | UCPTTariffSelect | — | 1, 2, 3, 4 | Set the active tariff 1 = Rate A (tariff 1) 2 = Rate B (tariff 2) 3 = Rate C (tariff 3) 4 = Rate D (tariff 4) NOTE: You can only set the tariff using this method if the Tariff Mode is set to by Communication. |

Network propagation rate setup

The following configuration properties help control network traffic by controlling the rate at which variable values are sent to your LNS.

| nci variable | UCPTs / SCPTs | Applies to... | Description |
|-------------------|-----------------|---|--|
| nciMaxNvSntPerSec | UCPTNVUpdtLimit | <ul style="list-style-type: none"> • nciErrors • nciAllEnergy • nciAllPower • nciAllVoltage • nciAllCurrent • nciAllPowerFactor • nciFrequency. | <p>Limits the total number of updates sent per second for listed nci variables.</p> <p>If more than the specified number of updates are queued to be sent out in any 1 second period, the excess updates are delayed until the next second to reduce network traffic. The number of updates sent per second varies depending on the connection type updates from network variables that are not controlled by this configuration property.</p> |
| nciErrors | SCPTmaxSendTime | nvoErrors | <p>Maximum interval, in seconds, between transmissions of error values to the network.</p> <p>The value of the applicable variable is sent after the interval has elapsed, regardless of whether or not the value of the variable has changed. The counter is reset to 0.</p> |
| nciAllEnergy | SCPTminSendTime | <p>Floating-point energy values:</p> <ul style="list-style-type: none"> • nvoTotWhImp • nvoTotWhExp • nvoTotVARhImp • nvoTotVARhExp • nvoPartialWh • nvoPartialVARh • nvoPh1Wh • nvoPh2Wh • nvoPh3Wh • nvoTariffAWh • nvoTariffBWh • nvoTariffCWh • nvoTariffDWh | |
| nciAllPower | SCPTminSendTime | <ul style="list-style-type: none"> • nvoActPowerPh1 • nvoActPowerPh2 • nvoActPowerPh3 • nvoActPower-Sum • nvoRctPower-Sum • nvoAppPower-Sum | <p>The minimum interval, in seconds, between consecutive transmissions of the listed variable values to the network.</p> <p>No updates to the value of the applicable variables are sent over the network until the minimum interval has elapsed, regardless of whether or not the value of the variable has changed.</p> |
| nciAllVoltage | SCPTminSendTime | <ul style="list-style-type: none"> • nvoVoltsL1N • nvoVoltsL2N • nvoVoltsL3N • nvoVoltsLNAvg • nvoVoltsL1L2 • nvoVoltsL2L3 • nvoVoltsL3L1 • nvoVoltsLLAvg | <p>After an update is sent, the counter is reset to 0.</p> |
| nciAllCurrent | SCPTminSendTime | <ul style="list-style-type: none"> • nvoCurrentPh1 • nvoCurrentPh2 • nvoCurrentPh3 • nvoCurrentAvg | |
| nciAllPowerFactor | SCPTminSendTime | nvoAvgPwrFactor | |
| nciFrequency | SCPTminSendTime | nvoFrequency | |

Echelon LonMaker plug-in for data display and meter configuration

The information in this section assumes that you have an advanced understanding of system administration using Echelon LonMaker.

The LonMaker plug-in provides a graphical user interface where you can view meter values and configure meter settings. Once you install and register the plug-in with LonMaker, it opens instead of the default LonMaker browser when you browse the meter in LonMaker.

To add devices to LonMaker, you need access to the device service pin when commissioning the device or your need the device Neuron ID recorded in an accessible location.

Installing and registering the LonMaker plug-in

Before you install the plug-in:

- Download the plug-in and XIF file for your device from www.se.com or contact your sales representative to obtain these files.
- Make sure Echelon LonMaker is closed.

1. Navigate to the location where you saved the plug-in. Extract the files if they are in a .zip file.
2. Double-click setup.exe. A welcome screen appears. Click **Next**.
3. Select the installation folder where you want to install the plug-in. Click **Browse** if you want to select a different location. Click **Next**. A confirmation screen appears.
4. Click **Next** to begin the installation.

NOTE: If LonMaker is open, a message appears instructing you to close LonMaker and restart the plug-in installation.

A screen appears when the installation is complete. Click **Close**.

5. Navigate to **Start > Programs > Schneider Electric** and select the registration entry for the plug-in you installed (for example, **Schneider Electric iEM3275 Plugin Registration**). The **LNS Plugin Registration** dialog box appears, indicating that registration is complete.

Make sure that the plug-in appears in the list of registered plug-ins in LonMaker before you try to connect to a meter using the plug-in. If it does not appear, you may need to re-register the plug-in.

Once the plug-in is installed and registered, add the meter to LonMaker. You can either read the template (.XIF) from the device during commissioning or select the EnergyMeter5A or EnergyMeter63A template when you add the device to LonMaker.

Browsing the meter using the LonMaker plug-in

In order to use the plug-in to view data and configure the meter:

- The plug-in must be installed and registered.
- The meter must be added to LonMaker and commissioned.

1. Open LonMaker.
2. Right-click the meter icon and select **Browse**. The meter plug-in appears.

NOTE: If the meter-specific plug-in does not open, the plug-in may not be correctly registered or the meter may not be properly commissioned in LonMaker. Double-check the registration and meter commissioning. Refer to the Echelon LonMaker documentation for more information.

LonMaker plug-in interface

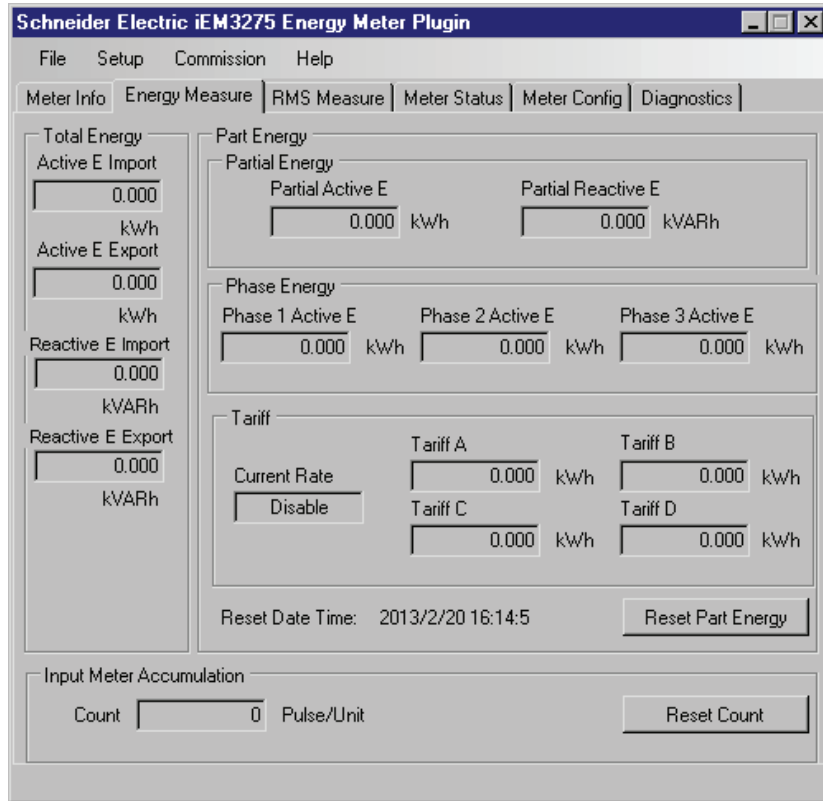

The plug-in has the following tabs:

| Tab name | Description |
|----------------|---|
| Meter Info | This tab provides basic information about the meter (for example, model and serial number) and any active error codes. |
| Energy Measure | This tab provides total and partial energy values as well as energy per phase and energy by tariff information. You can also reset energy and input metering accumulations on this tab. |
| RMS Measure | This tab provides power, current, and voltage values as well as frequency and power factor information. |
| Meter Status | This tab provides information on the settings and status of the digital input and alarms as well as existing power system settings. |
| Meter Config | This tab provides access to the meter configuration properties, allowing you to configure power system, digital input, alarm, Multi Tariff and time settings. NOTE: If you see a message that the configuration was unsuccessful, make sure: 1) the meter is properly commissioned in LonMaker and the plug-in is communicating with the meter, and 2) that Com. Protection is disabled on the meter. |
| Diagnostics | This tab provides LonMaker diagnostics information related to the meter. |

Communications via M-Bus

M-Bus communications overview

Communications via M-Bus protocol is available on iEM3135 / iEM3235 / iEM3335 meter models.

M-Bus is a master / slave communications protocol where the master initiates transactions and the slave(s) respond with the requested information or action. Data is transferred using hexadecimal telegrams.

The information in this section is intended for users with an advanced understanding of M-Bus protocol, their communications network and their power system.

Configuring basic communications settings

Before communicating with the meter via M-Bus protocol, use the HMI to configure the following settings:

| Setting | Possible values |
|-----------------|--|
| Baud rate | 300 600 1200 2400 4800 9600 |
| Primary address | 1 – 250 |

NOTE: For M-Bus communication, the device consumes 2 standard loads (2 Unit Loads or 2UL).

Key terms

| Term | Definition |
|-------------------|--|
| C-Field | The control or function field of the telegram. It provides information about the telegram, such as the direction of data flow (master to slave or slave to master), the status of the data flow and the function of the message. |
| CI-Field | The control information field of the telegram. It defines the type and sequence of data to be transmitted. |
| Fixed data header | Contains device and manufacturer identification information. |
| DIF | Data information field. The DIF contains information about the function of the data (for example, instantaneous versus maximum) and the data format (for example, 16-bit integer). |
| DIFE | Data information field extension. A DIFE contain additional information about the data, such as tariff and subunit. |
| Master | A device that issues commands and receives responses from slave devices. There can be only one master per serial network. |
| Slave | A device that provides information or performs actions in response to requests from the master. |
| VIF / VIFE | Value information field and value information field extension. The VIF and VIFE contain information about the value (for example, whether it is an energy or power value). The meter uses both primary VIFE (as detailed in the M-Bus protocol documentation) and manufacturer-specific VIFE. |

M-Bus protocol support

The meter supports the M-Bus protocol as follows:

- Mode 1 communications (least significant bit first).
- Telegram formats:
 - Single character
 - Short frame
 - Long frame
- Function codes (C-field bits 3-0):
 - SND_NKE: Initiates of communications between the master and slave.
 - SND_UD: The master sends user data to the slave.
 - REQ_UD2: The master requests Class 2 user data from the slave.
 - RSP_UD: The slave sends requested data to the master.
- Secondary addressing in accordance with the M-Bus standard.
- Broadcast telegrams.

M-Bus protocol implementation

M-Bus tool for viewing data and configuring the meter

The M-Bus tool provides a graphical user interface where you can view meter data and configure meter settings. To obtain the tool, go to www.se.com and search for your meter model then select Downloads or contact your local Schneider Electric representative.

Communications LED indicator for M-Bus meters

The communications LED indicates the status of the communications between the meter and the network as follows:

| LED state | Description |
|---------------------|---|
| The LED is flashing | Communication with the meter has been established. NOTE: The LED flashes even if there is a communications error. |
| The LED is off | There is no active communication. |

Variable data structure telegram information

Fixed data header

| Byte 1 – 4 | Byte 5 – 6 | Byte 7 | Byte 8 | Byte 9 | Byte 8 | Byte 11 – 12 |
|--|-------------------------------|--|----------------------|---------------------------------------|------------------------------------|--------------|
| Identification No. | Manufacturer | Version | Medium | Access No. | Status | Signature |
| Serial number of the meter in an 8-digit, BCD coded format The serial number can also be found on the meter front panel | 4CA3 hex = Schneider Electric | Firmware version of the communications board 10 = version 1.0 | 02 hex (electricity) | Counter of successful access attempts | Indicates M-Bus application errors | Not used |

Decoding secondary address and M-Bus serial number

Each M-Bus meter has a unique secondary address. The secondary address of a meter includes 4 parts: serial number, M-Bus firmware version, medium, and manufacturer.

The format of the secondary address is **SSSSSSSM AVVME**. The decoding of the secondary address is given below:

SSSSSSSS: Serial Number

MA: Manufacturer

VV: M-Bus Firmware Version

ME: Medium

Common Medium list:

01 = Oil

02 = Electricity

03 = Gas

04 = Heat

The main board serial number format is **YYWWDNNN**. The decoding of the M-Bus serial number is given below followed with an example:

YY: Year

WW: Week

D: Day

NNN: Number

The following example distinguishes the M-Bus serial number for iEM3135 / iEM3235 / iEM3335 meters.

| Main Board SN | M-Bus SN | | |
|------------------------|---------------------------|---------------------------|---------------------------|
| | iEM3135 | iEM3235 | iEM3335 |
| 14053100 └─┬─ YY | 01053100 └─┬─ YY-13 | 31053100 └─┬─ YY+17 | 61053100 └─┬─ YY+47 |

Data record header information

Data formats used by the meter (DIF bits 3 – 0)

NOTE: x in the hex value is determined by bits 7 – 4 of the DIF.

| Format | bin | hex |
|-----------------|------|-----|
| No data | 0000 | x0 |
| 8-bit integer | 0001 | x1 |
| 16-bit integer | 0010 | x2 |
| 24-bit integer | 0011 | x3 |
| 32-bit integer | 0100 | x4 |
| 32-bit real | 0101 | x5 |
| 48-bit integer | 0110 | x6 |
| 64-bit integer | 0111 | x7 |
| Variable length | 1101 | xD |

Data function types used by the meter (DIF bits 5 – 4)

| Function type | bin |
|---------------|-----|
| Instantaneous | 00 |
| Maximum | 01 |

Primary VIF used by the meter

NOTE: E denotes the extension bit; x in the hex value is determined by bits 7 – 4 of the VIF.

| Primary VIF | bin | hex | Description |
|----------------------------|-----------|-----|---|
| Energy | E000 0011 | x3 | Wh with a resolution of 10 ⁰ in int64 kWh with a resolution of 10 ³ in float32 |
| Power | E000 1110 | xE | kW with a resolution of 10 ³ |
| Time point | E110 1101 | xD | Date and time in data type F, as detailed in the M-Bus protocol documentation |
| Bus address | E111 1010 | xA | Data type C (unsigned integer), as detailed in the M-Bus protocol documentation |
| Primary VIFE | 1111 1101 | FD | Indicates that the first VIFE is a primary VIF extension |
| Manufacturer-specific VIFE | 1111 1111 | FF | Indicates that the next VIFE is manufacturer specific |

Primary VIFE codes used by the meter

The primary VIFE codes in the table below are used by the meter when the VIF equals FD hex (1111 1101 bin).

NOTE: E denotes the extension bit; x in the hex value is determined by bits 7-4 of the VIFE.

| Primary VIFE codes | bin | hex | Additional information |
|--------------------|-----------|-----|--|
| Manufacturer | E000 1010 | xA | — |
| Model | E000 1100 | xC | — |
| Voltage | E100 1001 | x9 | Volts with a resolution of 10 ⁰ |
| Current | E101 1100 | xC | Amps with a resolution of 10 ⁰ |
| Digital output | E001 1010 | xA | — |
| Digital input | E001 1011 | xB | — |
| Cumulation counter | E110 0001 | x1 | Input metering accumulation |
| Error flag | E001 0111 | x7 | — |

Manufacturer-specific VIFE codes

The manufacturer-specific VIFE codes in the table below are used by the meter when the VIF equals FF hex (1111 1111 bin).

NOTE: E denotes the extension bit; the hex value assumes E = 0.

| Description | bin | hex |
|------------------------------------|-----------|-----|
| L1 value | E000 0001 | 01 |
| L2 value | E000 0010 | 02 |
| L3 value | E000 0011 | 03 |
| Export energy value | E000 1001 | 09 |
| Partial energy value | E000 1101 | 0D |
| Average current | E000 0000 | 00 |
| L-N Avg | E000 0100 | 04 |
| L1-L2 | E000 0101 | 05 |
| L2-L3 | E000 0110 | 06 |
| L3-L1 | E000 0111 | 07 |
| L-L Avg | E000 1000 | 08 |
| Power Factor | E000 1010 | 0A |
| Frequency | E000 1011 | 0B |
| Energy reset date and time | E000 1100 | 0C |
| Input metering reset date and time | E000 1110 | 0E |
| Input metering accumulation | E000 1111 | 0F |
| Active tariff (Energy active rate) | E001 0000 | 10 |
| Tariff control mode | E001 0001 | 11 |
| Meter operation timer | E010 0000 | 20 |
| Number of phases | E010 0001 | 21 |
| Number of wires | E010 0010 | 22 |
| Power system configuration | E010 0011 | 23 |
| Nominal frequency | E010 0100 | 24 |
| Number of VTs | E010 0101 | 25 |
| VT primary | E010 0110 | 26 |
| VT secondary | E010 0111 | 27 |
| Number of CTs | E010 1000 | 28 |
| CT Primary | E010 1001 | 29 |

| Description | bin | hex |
|---|-----------|-----|
| CT Secondary | E010 1010 | 2A |
| VT connection type | E010 1011 | 2B |
| Energy pulse duration | E010 1100 | 2C |
| Digital output association with active energy pulsing | E010 1101 | 2D |
| Pulse weight | E010 1110 | 2E |
| Pulse constant | E010 1111 | 2F |
| Digital input association | E011 0000 | 30 |
| Digital input status | E011 0010 | 32 |
| Overload alarm setup | E011 0100 | 34 |
| Pickup setpoint | E011 0101 | 35 |
| Digital output association with overload alarm | E011 0110 | 36 |
| Activated status | E011 0111 | 37 |
| Acknowledgment | E011 1000 | 38 |
| Date and time of last alarm | E011 1001 | 39 |
| Value at last alarm | E011 1010 | 3A |

Telegram information for data records

The following sections outline the telegram information used in data records. The tables contain the following information (if applicable):

- Data format in hex (for example, 16-bit integer)
- Primary VIF in hex
- Primary VIFE codes in bin and hex
- Manufacturer-specific VIFE codes in bin and hex

Meter information

NOTE: E denotes the extension bit; the hex value assumes E = 0.

| Data format | Primary VIF Extension | | Description |
|-------------|-----------------------|-----|--|
| | bin | hex | |
| 0D | E000 1010 | 0A | Manufacturer 18-bit ASCII = Schneider Electric |
| 0D | E000 1100 | 0C | Model |
| 0D | E000 1110 | 0E | Firmware version |
| 03 | E0001 0111 | 17 | Meter error codes: 0 = Code 101: EEPROM error 1 = Code 102: No calibration table 2 = Code 201: Mismatch between frequency settings and frequency measurements 3 = Code 202: Mismatch between wiring settings and wiring inputs 4 = Code 203: Phase sequence reversed 5 = Code 204: Total active energy negative due to incorrect voltage or current connections 6 = Code 205: Date and time are reset due to a power failure 7 = Code 206: Pulse missing due to overspeed of energy pulse output 8 = Code 207: Abnormal internal clock function 9 = Internal data bus communications error |

Energy and energy by tariff measurements (INT64 and FLOAT32)

The energy and energy by tariff measurements listed below are preserved through power failures. An addition of energy values in FLOAT32 format have been provided with the existing 64-bit registers.

NOTE: E denotes the extension bit; the hex value assumes E = 0.

| Data format | DIFE | Primary VIF | Primary VIFE | | Manufacturer-specific VIFE | | Description |
|----------------|-------|-------------|--------------|-----|----------------------------|-----|---|
| | | | bin | hex | bin | hex | |
| INT64 | | | | | | | |
| 07 | — | 03 | — | — | — | — | Total active energy import |
| 07 | — | 83 | — | — | E000 1001 | 09 | Total active energy export |
| 87 | 40 | 03 | — | — | — | — | Total reactive energy import |
| 87 | 40 | 83 | — | — | E000 1001 | 09 | Total reactive energy export |
| 07 | — | 83 | — | — | E000 1101 | 0D | Partial active energy import |
| 87 | 40 | 83 | — | — | E000 1101 | 0D | Partial reactive energy import |
| 07 | — | 83 | — | — | E000 0001 | 01 | Active energy import phase 1 |
| 07 | — | 83 | — | — | E000 0010 | 02 | Active energy import phase 2 |
| 07 | — | 83 | — | — | E000 0011 | 03 | Active energy import phase 3 |
| 03 | — | — | — | — | E001 0000 | 10 | Active tariff 0 = Multi Tariff feature is disabled 1 = rate A (tariff 1) active 2 = rate B (tariff 2) active 3 = rate C (tariff 3) active 4 = rate D (tariff 4) active |
| 87 | 10 | 03 | — | — | — | — | Rate A (tariff 1) active energy import |
| 87 | 20 | 03 | — | — | — | — | Rate B (tariff 2) active energy import |
| 87 | 30 | 03 | — | — | — | — | Rate C (tariff 3) active energy import |
| 87 | 80 10 | 03 | — | — | — | — | Rate D (tariff 4) active energy import |
| 07 | — | — | E110 0001 | 61 | — | — | Input metering accumulation |
| 04 | — | ED | — | — | E000 1100 | 0C | Date and time of last partial energy reset |
| 04 | — | ED | — | — | E000 1110 | 0E | Date and time of last input metering reset |
| FLOAT32 | | | | | | | |
| 05 | — | 03 | — | — | — | — | Total active energy import |
| 05 | — | 83 | — | — | E000 1001 | 09 | Total active energy export |
| 85 | 40 | 83 | — | — | — | — | Total reactive energy import |
| 85 | 40 | 83 | — | — | E000 1001 | 09 | Total reactive energy export |
| 05 | — | 83 | — | — | E000 1101 | 0D | Partial active energy import |
| 85 | 40 | 83 | — | — | E000 1101 | 0D | Partial reactive energy import |
| 05 | — | 83 | — | — | E000 0001 | 01 | Active energy import phase 1 |
| 05 | — | 83 | — | — | E000 0010 | 02 | Active energy import phase 2 |
| 05 | — | 83 | — | — | E000 0011 | 03 | Active energy import phase 3 |
| 85 | 10 | 03 | — | — | — | — | Rate A (tariff 1) active energy import |
| 85 | 20 | 03 | — | — | — | — | Rate B (tariff 2) active energy import |
| 85 | 30 | 03 | — | — | — | — | Rate C (tariff 3) active energy import |

| Data format | DIFE | Primary VIF | Primary VIFE | | Manufacturer-specific VIFE | | Description |
|-------------|-------|-------------|--------------|-----|----------------------------|-----|--|
| | | | bin | hex | bin | hex | |
| 85 | 80 10 | 03 | — | | — | — | Rate D (tariff 4) active energy import |
| 05 | — | — | E110 0001 | 61 | — | — | Input metering accumulation |

NOTE: The unit of FLOAT32 energy value is kWh/kVARh.

Instantaneous measurements

NOTE: E denotes the extension bit; the hex value assumes E = 0.

| Data format | DIFE | Primary VIF | Primary VIFE | | Manufacturer-specific VIFE | | Description |
|-------------|-------|-------------|--------------|-----|----------------------------|-----|---------------------------------|
| | | | bin | hex | bin | hex | |
| 05 | — | AE | — | — | E000 0001 | 01 | Active power Phase 1 |
| 05 | — | AE | — | — | E000 0010 | 02 | Active power Phase 2 |
| 05 | — | AE | — | — | E000 0011 | 03 | Active power Phase 3 |
| 05 | — | 2E | — | — | — | — | Total active power |
| 85 | 40 | 2E | — | — | — | — | Total reactive power |
| 85 | 80 40 | 2E | — | — | — | — | Total apparent power |
| 05 | — | — | E100 1001 | C9 | E000 0001 | 01 | Voltage L1-N |
| 05 | — | — | E100 1001 | C9 | E000 0010 | 02 | Voltage L2-N |
| 05 | — | — | E100 1001 | C9 | E000 0011 | 03 | Voltage L3-N |
| 05 | — | — | E100 1001 | C9 | E000 0100 | 04 | Average voltage line-to-neutral |
| 05 | — | — | E100 1001 | C9 | E000 0101 | 05 | Voltage L1-L2 |
| 05 | — | — | E100 1001 | C9 | E000 0110 | 06 | Voltage L2-L3 |
| 05 | — | — | E100 1001 | C9 | E000 0111 | 07 | Voltage L3-L1 |
| 05 | — | — | E100 1001 | C9 | E000 1000 | 08 | Average voltage line-to-line |
| 05 | — | — | E101 1100 | DC | E000 0001 | 01 | Phase 1 current |
| 05 | — | — | E101 1100 | DC | E000 0010 | 02 | Phase 2 current |
| 05 | — | — | E101 1100 | DC | E000 0011 | 03 | Phase 3 current |
| 05 | — | — | E101 1100 | DC | E000 0000 | 00 | Average current |
| 05 | — | — | — | — | E000 1010 | 0A | Total power factor |
| 05 | — | — | — | — | E000 1011 | 0B | Frequency |

Meter status information

Use the following information to read system and status information from the meter. See the section regarding telegram information for meter configuration for more information on writing to the meter.

Date and time information

NOTE: E denotes the extension bit; the hex value assumes E = 0.

| Data format | Primary VIF | Manufacturer specific VIFE | | Description |
|-------------|-------------|----------------------------|-----|---|
| | | bin | hex | |
| 04 | 6D | — | — | Meter date and time (DD/MM/YYYY hh:mm:ss) |
| 06 | — | E010 0000 | 20 | Meter operation timer: the time in seconds since the device was last powered up |

Power system configuration information

NOTE: E denotes the extension bit; the hex value assumes E = 0.

| Data format | Manufacturer specific VIFE | | Description |
|-------------|----------------------------|-----|---|
| | bin | hex | |
| 03 | E010 0011 | 23 | Power system configuration: 0 = 1PH2W L-N 1 = 1PH2W L-L 2 = 1PH3W L-L with N 3 = 3PH3W 11 = 3PH4W 13 = 1PH4 wire multi L with N |
| 03 | E010 0010 | 22 | Number of wires 2, 3, 4 |
| 03 | E010 0001 | 21 | Number of phases 1, 3 |
| 03 | E010 1000 | 29 | Number of CTs 1, 2, 3 NOTE: Applicable only for iEM3235 |
| 03 | E010 0101 | 25 | Number of VTs 0 to 10 NOTE: Applicable only for iEM3235 |
| 03 | E010 0110 | 26 | VT Primary NOTE: Applicable only for iEM3235 |
| 03 | E010 0111 | 27 | VT Secondary NOTE: Applicable only for iEM3235 |
| 03 | E010 1001 | 29 | CT Primary NOTE: Applicable only for iEM3235 |
| 03 | E010 1010 | 2A | CT Secondary NOTE: Applicable only for iEM3235 |
| 03 | E010 1011 | 2B | VT connection type: 0 = Direct connection, no VTs 1 = 3PH3W (2VTs) 2 = 3PH4W (3VTs) |
| 03 | E010 0100 | 24 | Nominal frequency 50, 60 |

Digital input and output status information

NOTE: E denotes the extension bit; the hex value assumes E = 0.

| Data format | Primary VIFE | | Manufacturer specific VIFE | | Description |
|-------------|--------------|-----|----------------------------|-----|--|
| | bin | hex | bin | hex | |
| 03 | E001 1011 | 1B | — | — | Digital input control mode: 0 = Normal (Input Status) 2 = Multi Tariff control 3 = Input metering 5 = All partial energy logs reset |
| 05 | — | — | E010 1111 | 2F | Pulse constant (pulses/unit) |
| 02 | — | — | E011 0010 | 32 | Digital input status: 0 = relay open 1 = relay closed NOTE: This information only applies if the digital input control mode is set to Input Status. |
| 03 | — | — | E011 0000 | 30 | Digital input association with partial energy data reset 0 = Digital input is not associated with the partial energy reset 1 = Digital input is associated with the partial energy reset |
| 03 | — | — | E010 1100 | 2C | Energy pulse duration in milliseconds NOTE: This information only applies if the digital output mode is set to energy pulsing. |
| 05 | — | — | E010 1110 | 2E | Pulse weight of the digital output NOTE: This information only applies if the digital output mode is set to energy pulsing. |
| 03 | E001 1010 | 1A | — | — | Digital output control mode 2 = for Alarm 3 = for Pulse (kWh) 0xFFFF = Disabled |
| 03 | — | — | E010 1101 | 2D | Digital output association with energy pulsing: 0 = Digital output disabled 1 = for Pulse (digital output is associated with active energy pulse output) |
| 02 | — | — | E011 0110 | 36 | Digital output association with overload alarm: 0x0000 = digital output disabled 0x0100 = for Alarm (digital output is associated with the overload alarm) |

Alarm status information

NOTE: E denotes the extension bit; the hex value assumes E = 0.

| Data format | Primary VIF | Manufacturer specific VIFE | | Description |
|-------------|-------------|----------------------------|-----|---|
| | | bin | hex | |
| 02 | — | E011 0111 | 37 | Alarm status: 0x0000 = Alarm is inactive 0x0100 = Alarm is active |
| 02 | — | E011 1000 | 38 | Acknowledgement status: 0x0000 = historic alarm is acknowledged by the user 0x0100 = historic alarm is unacknowledged by the user |
| 04 | ED | E011 1001 | 39 | Timestamp of last alarm (DD/MM/YYYY hh:mm:ss) |
| 05 | — | E011 1010 | 3A | Value at last alarm |
| 02 | — | E011 0100 | 34 | Overload alarm configuration: 0x0000 = disabled 0x0100 = enabled |
| 05 | — | E011 0101 | 35 | The pickup setpoint in kW for the overload alarm |

Telegram decode information (all values are in hexadecimal)

1st telegram information

| Byte No | Size | Value | Description |
|---------|------|-----------------------|--|
| 1 | 1 | 68 | Start character |
| 2 | 1 | F4 | L-field, calculated from C field to last user data |
| 3 | 1 | F4 | L-field, repeated |
| 4 | 1 | 68 | Start character |
| 5 | 1 | 08 | C-field, RSP_UD |
| 6 | 1 | XX | A-field, address |
| 7 | 1 | 72 | CI-field, variable data respond, LSB first |
| 8 – 11 | 4 | XXXX | Identification number, 8 BCD digits |
| 12 – 13 | 2 | 4CA3 | Manufacturer: SCH |
| 14 | 1 | 00 | Version |
| 15 | 1 | 02 | Medium, 02 = Electricity |
| 16 | 1 | X | Number of accesses |
| 17 | 1 | X | Status |
| 18 – 19 | 2 | 0000 | Signature (0000 = no encryption) |
| 20 | 1 | 0D | DIF size, special function |
| 21 | 1 | FD | VIF extension of VIF-codes |
| 22 | 1 | 0A | Manufacturer name |
| 23 | 1 | 12 | String length |
| 24 – 41 | 18 | XXXXXXXXXXXXXXXX-XXXX | Schneider Electric |
| 42 | 1 | 0D | DIF size, special function |
| 43 | 1 | 0D | VIF extension of VIF-codes |
| 44 | 1 | FD | Model |
| 45 – 53 | 9 | 0C | Meter model |
| 54 | 1 | XXXXXXXX | DIF size, special function |
| 55 | 1 | 0D | VIF extension of VIF-codes |
| 56 | 1 | FD | Firmware version |
| 57 – 64 | 8 | 0E | Meter Firmware version |
| 65 | 1 | XXXXXXXX | DIF size, 24 Bit Integer |
| 66 | 1 | 03 | VIF extension of VIF-codes |
| 67 | 1 | FD | Error flags |
| 68 – 70 | 3 | 17 | Error flags (Diagnostics active bitmaps(1)) |
| 71 | 1 | XXX | DIF size, 32 Bit Real |
| 72 | 1 | 05 | VIF extension of VIF-codes |
| 73 | 1 | FD | Current |
| 74 | 1 | DC | VIF next byte is manufacturer specific |
| 75 | 1 | FF | L1 |
| 76 – 79 | 4 | 01 | Current per phase,l1 |
| 80 | 1 | XXXX | DIF size, 32 Bit Real |
| 81 | 1 | 05 | VIF extension of VIF-codes |
| 82 | 1 | FD | Current |

| Byte No | Size | Value | Description |
|-----------|------|-------|--|
| 83 | 1 | DC | VIF next byte is manufacturer specific |
| 84 | 1 | FF | L2 |
| 85 – 88 | 4 | 02 | Current per phase,I2 |
| 89 | 1 | XXXX | DIF size, 32 Bit Real |
| 90 | 1 | 05 | VIF extension of VIF-codes |
| 91 | 1 | FD | Current |
| 92 | 1 | DC | VIF next byte is manufacturer specific |
| 93 | 1 | FF | L3 |
| 94 – 97 | 4 | 03 | Current per phase,I3 |
| 98 | 1 | XXXX | DIF size, 32 Bit Real |
| 99 | 1 | 05 | VIF extension of VIF-codes |
| 100 | 1 | FD | Current |
| 101 | 1 | DC | VIF next byte is manufacturer specific |
| 102 | 1 | FF | Average |
| 103 – 106 | 4 | 00 | Average current |
| 107 | 1 | XXXX | DIF size, 32 Bit Real |
| 108 | 1 | 05 | VIF extension of VIF-codes |
| 109 | 1 | FD | Voltage |
| 110 | 1 | C9 | VIF next byte is manufacturer specific |
| 111 | 1 | FF | L1-L2 |
| 112 – 115 | 4 | 05 | Voltage,L1-L2 |
| 116 | 1 | XXXX | DIF size, 32 Bit Real |
| 117 | 1 | 05 | VIF extension of VIF-codes |
| 118 | 1 | C9 | Voltage |
| 119 | 1 | FF | VIF next byte is manufacturer specific |
| 120 | 1 | 06 | L2-L3 |
| 121 – 124 | 4 | XXXX | Voltage,L2-L3 |
| 125 | 1 | 05 | DIF size, 32 Bit Real |
| 126 | 1 | FD | VIF extension of VIF-codes |
| 127 | 1 | C9 | Voltage |
| 128 | 1 | FF | VIF next byte is manufacturer specific |
| 129 | 1 | 07 | L3-L1 |
| 130 – 133 | 4 | XXXX | Voltage,L3-L1 |
| 134 | 1 | 05 | DIF size, 32 Bit Real |
| 135 | 1 | FD | VIF extension of VIF-codes |
| 136 | 1 | C9 | Voltage |
| 137 | 1 | FF | VIF next byte is manufacturer specific |
| 138 | 1 | 08 | L-L Average |
| 139 – 142 | 4 | XXXX | Average voltage, L -L |
| 143 | 1 | 05 | DIF size, 32 Bit Real |
| 144 | 1 | FD | VIF extension of VIF-codes |
| 145 | 1 | C9 | Voltage |
| 146 | 1 | FF | VIF next byte is manufacturer specific |
| 147 | 1 | 01 | L1 |

| Byte No | Size | Value | Description |
|-----------|------|-------|--|
| 148 – 151 | 4 | XXXX | Voltage, L1 |
| 152 | 1 | 05 | DIF size, 32 Bit Real |
| 153 | 1 | FD | VIF extension of VIF-codes |
| 154 | 1 | C9 | Voltage |
| 155 | 1 | FF | VIF next byte is manufacturer specific |
| 156 | 1 | 02 | L2 |
| 157 – 160 | 4 | XXXX | Voltage, L2 |
| 161 | 1 | 05 | DIF size, 32 Bit Real |
| 162 | 1 | FD | VIF extension of VIF-codes |
| 163 | 1 | C9 | Voltage |
| 164 | 1 | FF | VIF next byte is manufacturer specific |
| 165 | 1 | 03 | L3 |
| 166 – 169 | 4 | XXXX | Voltage, L3 |
| 170 | 1 | 05 | DIF size, 32 Bit Real |
| 171 | 1 | FD | VIF extension of VIF-codes |
| 172 | 1 | C9 | Voltage |
| 173 | 1 | FF | VIF next byte is manufacturer specific |
| 174 | 1 | 04 | L-N, average |
| 175 – 178 | 4 | XXXX | Average, L-N |
| 179 | 1 | 05 | DIF size, 32 Bit Real |
| 180 | 1 | AE | Power |
| 181 | 1 | FF | VIF next byte is manufacturer specific |
| 182 | 1 | 01 | L1 |
| 183 – 186 | 4 | XXXX | Power,L1 |
| 187 | 1 | 05 | DIF size, 32 Bit Real |
| 188 | 1 | AE | Power |
| 189 | 1 | FF | VIF next byte is manufacturer specific |
| 190 | 1 | 02 | L2 |
| 191 – 194 | 4 | XXXX | Power,L2 |
| 195 | 1 | 05 | DIF size, 32 Bit Real |
| 196 | 1 | AE | Power |
| 197 | 1 | FF | VIF next byte is manufacturer specific |
| 198 | 1 | 03 | L3 |
| 199 – 202 | 4 | XXXX | Power,L3 |
| 203 | 1 | 05 | DIF size, 32 Bit Real |
| 204 | 1 | 2E | Power |
| 205 – 208 | 4 | XXXX | Total power |
| 209 | 1 | 85 | DIF size, 32 Bit Real |
| 210 | 1 | 40 | DIFE: Unit 1 |
| 211 | 1 | 2E | Power |
| 212 – 215 | 4 | XXXX | Reactive power |
| 216 | 1 | 85 | DIF size, 32 Bit Real |
| 217 | 1 | 80 | DIFE |
| 218 | 1 | 40 | DIFE: Unit 2 |

| Byte No | Size | Value | Description |
|-----------|------|----------|---|
| 219 | 1 | 2E | Power |
| 220 – 223 | 4 | XXXX | Apparent power |
| 224 | 1 | 05 | DIF size, 32 Bit Real |
| 225 | 1 | FF | VIF next byte is manufacturer specific |
| 226 | 1 | 0A | Power factor |
| 227 – 230 | 4 | XXXX | Power factor value |
| 231 | 1 | 05 | DIF size, 32 Bit Real |
| 232 | 1 | FF | VIF next byte is manufacturer specific |
| 233 | 1 | 0B | Frequency |
| 234 – 237 | 4 | XXXX | Frequency value |
| 238 | 1 | 07 | DIF size, 64 Bit Integer |
| 239 | 1 | 03 | Energy |
| 240 – 247 | 8 | XXXXXXXX | Total Active Energy Import |
| 248 | 1 | 1F | DIF, more records will follow in next telegram |
| 249 | 1 | X | CS checksum, calculated from C field to last data |
| 250 | 1 | 16 | Stop character |

NOTE: Error flags illustrate:

0 = Inactive

1 = Active

Bit0 = Code 101

Bit1 = Code 102

Bit2 = Code 201

Bit3 = Code 202

Bit4 = Code 203

Bit5 = Code 204

Bit6 = Code 205

Bit7 = Code 206

Bit8 = Code 207

2nd telegram information

| Byte No | Size | Value | Description |
|---------|------|-------|--|
| 1 | 1 | 68 | Start character |
| 2 | 1 | F6 | L-field, calculated from C field to last user data |
| 3 | 1 | F6 | L-field, repeated |
| 4 | 1 | 68 | Start character |
| 5 | 1 | 08 | C-field, RSP_UD |
| 6 | 1 | X | A-field, address |
| 7 | 1 | 72 | CI-field, variable data respond, LSB first |
| 8 – 11 | 4 | XXXX | Identification number, 8 BCD digits |
| 12 – 13 | 2 | 4CA3 | Manufacturer: SCH |
| 14 | 1 | 00 | Version |
| 15 | 1 | 02 | Medium, 02 = Electricity |
| 16 | 1 | X | Number of accesses |

| Byte No | Size | Value | Description |
|-----------|------|----------|--|
| 17 | 1 | 00 | Status |
| 18 – 19 | 2 | 0000 | Signature (0000 = no encryption) |
| 20 | 1 | 07 | DIF size, 64 Bit Integer |
| 21 | 1 | 83 | Energy |
| 22 | 1 | FF | VIF next byte is manufacturer specific |
| 23 | 1 | 09 | Export energy |
| 24 – 31 | 8 | XXXXXXXX | Total Active Energy Export |
| 32 | 1 | 87 | DIF size, 64 Bit Integer |
| 33 | 1 | 87 | DIFE: Unit1 |
| 34 | 1 | 40 | Energy |
| 35 – 42 | 8 | 03 | Total Reactive Energy Import |
| 43 | 1 | XXXXXXXX | DIF size, 64 Bit Integer |
| 44 | 1 | 87 | DIFE:Unit 1 |
| 45 | 1 | 40 | Energy |
| 46 | 1 | 83 | VIF next byte is manufacturer specific |
| 47 | 1 | FF | Export energy |
| 48 – 55 | 8 | 09 | Total Reactive Energy Export |
| 56 | 1 | XXXXXXXX | DIF size, 32 Bit Integer |
| 57 | 1 | 04 | Date/Time |
| 58 | 1 | ED | VIF next byte is manufacturer specific |
| 59 | 1 | FF | Energy Reset |
| 60 – 63 | 4 | 0C | Energy Reset Date/Time |
| 64 | 1 | XXXX | DIF size, 64 Bit Integer |
| 65 | 1 | 07 | Energy |
| 66 | 1 | 83 | VIF next byte is manufacturer specific |
| 67 | 1 | FF | Partial energy |
| 68 – 75 | 8 | 0D | Partial Active Energy Import |
| 76 | 1 | XXXXXXXX | DIF size, 64 Bit Integer |
| 77 | 1 | 87 | DIFE: Unit 1 |
| 78 | 1 | 40 | Energy |
| 79 | 1 | 83 | VIF next byte is manufacturer specific |
| 80 | 1 | FF | Partial Energy |
| 81 – 88 | 8 | 0D | Partial Reactive Energy Import |
| 89 | 1 | XXXXXXXX | DIF size, 64 Bit Integer |
| 90 | 1 | 07 | Energy |
| 91 | 1 | 83 | VIF next byte is manufacturer specific |
| 92 | 1 | FF | L1 |
| 93 – 100 | 8 | 01 | Active Energy Delivered, L1 |
| 101 | 1 | XXXXXXXX | DIF size, 64 Bit Integer |
| 102 | 1 | 07 | Energy |
| 103 | 1 | 83 | VIF next byte is manufacturer specific |
| 104 | 1 | FF | L2 |
| 105 – 112 | 8 | 02 | Active Energy Delivered, L2 |

| Byte No | Size | Value | Description |
|-----------|------|----------|--|
| 113 | 1 | XXXXXXXX | DIF size, 64 Bit Integer |
| 114 | 1 | 07 | Energy |
| 115 | 1 | 83 | VIF next byte is manufacturer specific |
| 116 | 1 | FF | L3 |
| 117 – 124 | 8 | 03 | Active Energy Delivered, L3 |
| 125 | 1 | XXXXXXXX | DIF size, 32 Bit Integer |
| 126 | 1 | 04 | Date/Time |
| 127 | 1 | ED | VIF next byte is manufacturer specific |
| 128 | 1 | 0E | Input metering reset |
| 129 – 132 | 4 | XXXX | Input Metering Accumulation Reset D/T |
| 133 | 1 | 07 | DIF size, 64 Bit Integer |
| 134 | 1 | FD | VIF extension |
| 135 | 1 | 61 | Input Metering Accumulation Channel 1 |
| 136 – 143 | 8 | XXXXXXXX | Input Metering Channel 1 Value |
| 144 | 1 | 03 | DIF size, 24 Bit Integer |
| 145 | 1 | FF | VIF next byte is manufacturer specific |
| 146 | 1 | 10 | Energy Active Rate |
| 147 – 149 | 3 | XXX | Energy Active Rate, Number |
| 150 | 1 | 87 | DIF size, 64 Bit Integer |
| 151 | 1 | 10 | DIFE: Tariff 1 |
| 152 | 1 | 03 | Energy |
| 153 – 160 | 8 | XXXXXXXX | Active Energy Delivered Rate 1 |
| 161 | 1 | 87 | DIF size, 64 Bit Integer |
| 162 | 1 | 20 | DIFE: Tariff 2 |
| 163 | 1 | 03 | Energy |
| 164 – 171 | 8 | XXXXXXXX | Active Energy Delivered Rate 2 |
| 172 | 1 | 87 | DIF size, 64 Bit Integer |
| 173 | 1 | 30 | DIFE: Tariff 3 |
| 174 | 1 | 03 | Energy |
| 175 – 182 | 8 | XXXXXXXX | Active Energy Delivered Rate 3 |
| 183 | 1 | 87 | DIF size, 64 Bit Integer |
| 184 | 1 | 80 | DIFE: Tariff 4 |
| 185 | 1 | 10 | DIFE: Tariff 4 |
| 186 | 1 | 03 | Energy |
| 187 – 194 | 8 | XXXXXXXX | Active Energy Delivered Rate 4 |
| 195 | 1 | 04 | DIF size, 32 Bit Integer |
| 196 | 1 | 6D | Date/Time |
| 197 – 200 | 4 | XXXX | System date/time |
| 201 | 1 | 03 | DIF size, 24 Bit Integer |
| 202 | 1 | FF | VIF next byte is manufacturer specific |
| 203 | 1 | 2C | Energy pulse duration |
| 204 – 206 | 3 | XXX | Value, Energy pulse duration |
| 207 | 1 | 03 | DIF size, 24 Bit Integer |

| Byte No | Size | Value | Description |
|-----------|------|-------|---|
| 208 | 1 | FF | VIF next byte is manufacturer specific |
| 209 | 1 | 2D | Digital output association |
| 210 – 212 | 3 | XXX | Value, Digital output association |
| 213 | 1 | 05 | DIF size, 32 Bit Real |
| 214 | 1 | FF | VIF next byte is manufacturer specific |
| 215 | 1 | 2E | Pulse weight |
| 216 – 219 | 4 | XXXX | Value, Pulse weight |
| 220 | 1 | 05 | DIF size, 32 Bit Real |
| 221 | 1 | FF | VIF next byte is manufacturer specific |
| 222 | 1 | 2F | Pulse constant |
| 223 – 226 | 4 | XXXX | Value, Pulse constant |
| 227 | 1 | 03 | DIF size, 24 Bit Integer |
| 228 | 1 | FF | VIF next byte is manufacturer specific |
| 229 | 1 | 30 | Digital input association |
| 230 – 232 | 3 | XXX | Value, Digital input association |
| 233 | 1 | 03 | DIF size, 24 Bit Integer |
| 234 | 1 | FD | VIF extension |
| 235 | 1 | 1B | Digital input control mode |
| 236 – 238 | 3 | XXX | Value, Digital input control mode |
| 239 | 1 | 02 | DIF size, 16 Bit Integer |
| 240 | 1 | FF | VIF next byte is manufacturer specific |
| 241 | 1 | 32 | Digital input status |
| 242 – 243 | 2 | XX | Value, Digital input status |
| 244 | 1 | 03 | DIF size, 24 Bit Integer |
| 245 | 1 | FD | VIF extension |
| 246 | 1 | 1A | Digital output control mode status |
| 247 – 249 | 3 | XXX | Value, Digital output control mode status |
| 250 | 1 | 1F | DIF, more records will follow in next telegram |
| 251 | 1 | X | CS checksum, calculated from C field to last data |
| 252 | 1 | 16 | Stop character |

3rd telegram information

| Byte No | Size | Value | Description |
|---------|------|-------|--|
| 1 | 1 | 68 | Start character |
| 2 | 1 | F1 | L-field, calculated from C field to last user data |
| 3 | 1 | F1 | L-field, repeated |
| 4 | 1 | 68 | Start character |
| 5 | 1 | 08 | C-field, RSP_UD |
| 6 | 1 | X | A-field, address |
| 7 | 1 | 72 | CI-field, variable data respond, LSB first |
| 8 – 11 | 4 | XXXX | Identification Number, 8 BCD digits |
| 12 – 13 | 2 | 4CA3 | Manufacturer: SCH |

| Byte No | Size | Value | Description |
|---------|------|--------|--|
| 14 | 1 | 00 | Version |
| 15 | 1 | 02 | Medium, 02 = Electricity |
| 16 | 1 | X | Number of accesses |
| 17 | 1 | 00 | Status |
| 18 – 19 | 2 | 0000 | Signature (0000 = no encryption) |
| 20 | 1 | 02 | DIF size, 16 Bit Integer |
| 21 | 1 | FF | VIF next byte is manufacturer specific |
| 22 | 1 | 34 | Overload alarm setup |
| 23 – 24 | 2 | XX | Value, Overload alarm setup |
| 25 | 1 | 05 | DIF size, 32 Bit Real |
| 26 | 1 | FF | VIF next byte is manufacturer specific |
| 27 | 1 | FF | Pickup setpoint |
| 28 – 31 | 4 | 35 | Value, Pickup setpoint |
| 32 | 1 | XXXX | DIF size, 16 Bit Integer |
| 33 | 1 | 02 | VIF next byte is manufacturer specific |
| 34 | 1 | FF | Digital output associate |
| 35 – 36 | 2 | 36 | Value, Digital output associate |
| 37 | 1 | XX | DIF size, 16 Bit Integer |
| 38 | 1 | 02 | VIF next byte is manufacturer specific |
| 39 | 1 | FF | Activated status |
| 40 – 41 | 2 | 37 | Value, Activated status |
| 42 | 1 | XX | DIF size, 16 Bit Integer |
| 43 | 1 | 02 | VIF next byte is manufacturer specific |
| 44 | 1 | FF | Unacknowledged status |
| 45 – 46 | 2 | 38 | Value, Unacknowledged status |
| 47 | 1 | XX | DIF size, 32 Bit Integer |
| 48 | 1 | 04 | Date/Time |
| 49 | 1 | ED | VIF next byte is manufacturer specific |
| 50 | 1 | FF | Date time last alarm |
| 51 – 54 | 4 | 39 | Value, Date time last alarm |
| 55 | 1 | XXXX | DIF size, 32 Bit Real |
| 56 | 1 | 05 | VIF next byte is manufacturer specific |
| 57 | 1 | FF | Value last alarm |
| 58 – 61 | 4 | 3A | Value last alarm |
| 62 | 1 | XXXX | DIF size, 48 Bit Integer |
| 63 | 1 | 06 | VIF next byte is manufacturer specific |
| 64 | 1 | FF | Meter operation time |
| 65 – 70 | 6 | 20 | Value, Meter operation time |
| 71 | 1 | XXXXXX | DIF size, 24 Bit Integer |
| 72 | 1 | 03 | VIF next byte is manufacturer specific |
| 73 | 1 | FF | Num of phases |
| 74 – 76 | 3 | 21 | Value, Num of phases |
| 77 | 1 | XXX | DIF size, 24 Bit Integer |

| Byte No | Size | Value | Description |
|-----------|------|-------|--|
| 78 | 1 | 03 | VIF next byte is manufacturer specific |
| 79 | 1 | FF | Num of wires |
| 80 – 82 | 3 | 22 | Value, Num of wires |
| 83 | 1 | XXX | DIF size, 24 Bit Integer |
| 84 | 1 | 03 | VIF next byte is manufacturer specific |
| 85 | 1 | FF | Power System Configuration |
| 86 – 88 | 3 | 23 | Value, Power System Configuration |
| 89 | 1 | XXX | DIF size, 24 Bit Integer |
| 90 | 1 | 03 | VIF next byte is manufacturer specific |
| 91 | 1 | FF | Nominal Frequency |
| 92 – 94 | 3 | 24 | Value, Nominal Frequency |
| 95 | 1 | 05 | DIF size, 32 Bit Real |
| 96 | 1 | 03 | Energy |
| 97 – 100 | 4 | XXXX | Total Active Energy Import |
| 101 | 1 | 05 | DIF size, 32 Bit Real |
| 102 | 1 | 83 | Energy |
| 103 | 1 | FF | VIF next byte is manufacturer specific |
| 104 | 1 | 09 | Export energy |
| 105 – 108 | 4 | XXXX | Total Active Energy Export |
| 109 | 1 | 85 | DIF size, 32 Bit Real |
| 110 | 1 | 40 | DIFE: Unit1 |
| 111 | 1 | 03 | Energy |
| 112 – 115 | 4 | XXXX | Total Reactive Energy Import |
| 116 | 1 | 85 | DIF size, 32 Bit Real |
| 117 | 1 | 40 | DIFE:Unit 1 |
| 118 | 1 | 83 | Energy |
| 119 | 1 | FF | VIF next byte is manufacturer specific |
| 120 | 1 | 09 | Export energy |
| 121 – 124 | 4 | XXXX | Total Reactive Energy Export |
| 125 | 1 | 05 | DIF size, 32 Bit Real |
| 126 | 1 | 83 | Energy |
| 127 | 1 | FF | VIF next byte is manufacturer specific |
| 128 | 1 | 0D | Partial energy |
| 129 – 132 | 4 | XXXX | Partial Active Energy Import |
| 133 | 1 | 85 | DIF size, 32 Bit Real |
| 134 | 1 | 40 | DIFE: Unit 1 |
| 135 | 1 | 83 | Energy |
| 136 | 1 | FF | VIF next byte is manufacturer specific |
| 137 | 1 | 0D | Partial Energy |
| 138 – 141 | 4 | XXXX | Partial Reactive Energy Import |
| 142 | 1 | 05 | DIF size, 32 Bit Real |
| 143 | 1 | 83 | Energy |
| 144 | 1 | FF | VIF next byte is manufacturer specific |

| Byte No | Size | Value | Description |
|-----------|------|-------|--|
| 145 | 1 | 01 | L1 |
| 146 – 149 | 4 | XXXX | Active Energy Delivered, L1 |
| 150 | 1 | 05 | DIF size, 32 Bit Real |
| 151 | 1 | 83 | Energy |
| 152 | 1 | FF | VIF next byte is manufacturer specific |
| 153 | 1 | 02 | L2 |
| 154 – 157 | 4 | XXXX | Active Energy Delivered, L2 |
| 158 | 1 | 05 | DIF size, 32 Bit Real |
| 159 | 1 | 83 | Energy |
| 160 | 1 | FF | VIF next byte is manufacturer specific |
| 161 | 1 | 03 | L3 |
| 162 – 165 | 4 | XXXX | Active Energy Delivered, L3 |
| 166 | 1 | 05 | DIF size, 32 Bit Real |
| 167 | 1 | FD | VIF extension |
| 168 | 1 | 61 | Input Metering Accumulation Channel 1 |
| 169 – 172 | 4 | XXXX | Input Metering Channel 1 Value |
| 173 | 1 | 85 | DIF size, 32 Bit Real |
| 174 | 1 | 10 | DIFE: Tariff 1 |
| 175 | 1 | 03 | Energy |
| 176 – 179 | 4 | XXXX | Active Energy Delivered Rate 1 |
| 180 | 1 | 85 | DIF size, 32 Bit Real |
| 181 | 1 | 20 | DIFE: Tariff 2 |
| 182 | 1 | 03 | Energy |
| 183 – 186 | 4 | XXXX | Active Energy Delivered Rate 2 |
| 187 | 1 | 85 | DIF size, 32 Bit Real |
| 188 | 1 | 30 | DIFE: Tariff 3 |
| 189 | 1 | 03 | Energy |
| 190 – 193 | 4 | XXXX | Active Energy Delivered Rate 3 |
| 194 | 1 | 85 | DIF size, 32 Bit Real |
| 195 | 1 | 80 | DIFE: Tariff 4 |
| 196 | 1 | 10 | DIFE: Tariff 4 |
| 197 | 1 | 03 | Energy |
| 198 – 201 | 4 | XXXX | Active Energy Delivered Rate 4 |
| 202 | 1 | 03 | DIF size, 24 Bit Integer |
| 203 | 1 | FF | VIF next byte is manufacturer specific |
| 204 | 1 | 25 | Number VTs |
| 205 – 207 | 3 | XXX | Value, Number VTs |
| 208 | 1 | 05 | DIF size, 32 Bit Real |
| 209 | 1 | FF | VIF next byte is manufacturer specific |
| 210 | 1 | 26 | VT Primary |
| 211 – 214 | 4 | XXXX | Value, VT Primary |
| 215 | 1 | 03 | DIF size, 24 Bit Integer |
| 216 | 1 | FF | VIF next byte is manufacturer specific |

| Byte No | Size | Value | Description |
|-----------|------|-------|---|
| 217 | 1 | 27 | VT Secondary |
| 218 – 220 | 3 | XXX | Value, VT Secondary |
| 221 | 1 | 03 | DIF size, 24 Bit Integer |
| 222 | 1 | FF | VIF next byte is manufacturer specific |
| 223 | 1 | 28 | Number CTs |
| 224 – 226 | 3 | XXX | Value, Number CTs |
| 227 | 1 | 03 | DIF size, 24 Bit Integer |
| 228 | 1 | FF | VIF next byte is manufacturer specific |
| 229 | 1 | 29 | CT Primary |
| 230 – 232 | 3 | XXX | Value, CT Primary |
| 233 | 1 | 03 | DIF size, 24 Bit Integer |
| 234 | 1 | FF | VIF next byte is manufacturer specific |
| 235 | 1 | 2A | CT Secondary |
| 236 – 238 | 3 | XXX | Value, CT Secondary |
| 239 | 1 | 03 | DIF size, 24 Bit Integer |
| 240 | 1 | FF | VIF next byte is manufacturer specific |
| 241 | 1 | 2B | VT connection type |
| 242 – 244 | 3 | XXX | Value, VT connection type |
| 245 | 1 | 0F | DIF indicating that this is the last telegram |
| 246 | 1 | X | CS checksum, calculated from C field to last data |
| 247 | 1 | 16 | Stop character |

4th telegram information

| Byte No | Size | Value | Description |
|---------|------|----------|--|
| 1 | 1 | 68 | Start character |
| 2 | 1 | X | L-field, calculated from C field to last user data |
| 3 | 1 | X | L-field, repeated |
| 4 | 1 | 68 | Start character |
| 5 | 1 | 08 | C-field, RSP_UD |
| 6 | 1 | X | A-field, address |
| 7 | 1 | 72 | CI-field, variable data respond, LSB first |
| 8 – 11 | 4 | XXXX | Identification number, 8 BCD digits |
| 12 – 13 | 2 | 4CA3 | Manufacturer: SCH |
| 14 | 1 | 00 | Version |
| 15 | 1 | 02 | Medium, 02 = Electricity |
| 16 | 1 | X | Number of accesses |
| 17 | 1 | X | Status |
| 18 – 19 | 2 | 0000 | Signature (0000 = no encryption) |
| 20 | 1 | 07 | DIF size, 64 Bit Integer |
| 21 | 1 | 03 | Energy |
| 22 – 29 | 8 | XXXXXXXX | Total Active Energy Import |
| 30 | 1 | 07 | DIF size, 64 Bit Integer |

| Byte No | Size | Value | Description |
|---------|------|----------|---|
| 31 | 1 | 83 | Energy |
| 32 | 1 | FF | VIF next byte is manufacturer specific |
| 33 | 1 | FF | Export energy |
| 34 – 41 | 8 | 09 | Total Active Energy Export |
| 42 | 1 | XXXXXXXX | DIF size, 32 Bit Real |
| 43 | 1 | 05 | Power |
| 44 – 47 | 4 | 2E | Total Power |
| 48 | 1 | XXXX | DIF indicating that this is the last telegram |
| 49 | 1 | 0F | CS checksum, calculated from C field to last data |
| 50 | 1 | X | Stop character |

Telegram information for meter configuration

You can use the information provided in this section to write to the meter using a SND_UD function.

NOTE: If Com. Protection is enabled, you may receive an error response when you try to configure the meter over communications.

You can also configure the meter using the M-Bus tool available from www.se.com.

Supported VIFE codes for meter configuration

NOTE: E denotes the extension bit; the hex value assumes E = 0.

| VIFE code | | Action | Description |
|-----------|-----|-------------------|---|
| bin | hex | | |
| E000 0000 | 00 | Write and replace | Replaces the old value with the new value |
| E000 0111 | 07 | Clear | Resets an accumulated value to 0 (zero) |

Date/time setup

| Data format | Primary VIF | Description |
|-------------|-------------|--|
| 04 | 6D | Type F data type, as described in the M-Bus protocol documentation Supports the date and time in the following format YYYY:MM:DD hh:mm:ss |

Power system setup

NOTE: E denotes the extension bit; the hex value assumes E = 0.

| SND_UD code | Data format | Manufacturer specific VIFE | | Range/Options | Description |
|-------------|-------------|----------------------------|-----|---------------------------|---|
| | | bin | hex | | |
| 00 | 02 | E010 0011 | 23 | 0, 1, 2, 3, 11, 13 | Power system configuration: 0 = 1PH2W L-N 1 = 1PH2W L-L 2 = 1PH3W L-L with N 3 = 3PH3W 11 = 3PH4W 13 = 1PH4 wire multi L with N |
| 00 | 02 | E010 0100 | 24 | 50, 60 | Nominal frequency |
| 00 | 05 | E010 0110 | 26 | VT Secondary to 1000000.0 | VT Primary NOTE: Applicable only for iEM3235 |
| 00 | 02 | E010 0111 | 27 | 100, 110, 115, 120 | VT Secondary NOTE: Applicable only for iEM3235 |
| 00 | 02 | E010 1000 | 28 | 1, 2, 3 | Number of CTs NOTE: Applicable only for iEM3235 |
| 00 | 02 | E010 1001 | 29 | 1 to 32767 | CT Primary NOTE: Applicable only for iEM3235 |
| 00 | 02 | E010 1010 | 2A | 1, 5 | CT Secondary NOTE: Applicable only for iEM3235 |
| 00 | 02 | E010 1011 | 2B | 0, 1, 2 | VT Connection Type: 0 = direct connect 1 = 3PH3W (2 VTs) 2 = 3PH4W (3 VTs) NOTE: Applicable only for iEM3235 |

Multi Tariff setup

NOTE: E denotes the extension bit; the hex value assumes E = 0.

| SND_UD code | Data format | Manufacturer specific VIFE | | Range/Options | Description |
|-------------|-------------|----------------------------|-----|---------------|---|
| | | bin | hex | | |
| 00 | 02 | E001 0001 | 11 | 0,1 | Set Multi Tariff control mode to Disabled or by Communication: 0 = Disabled 1 = by Communication NOTE: To configure the Multi Tariff feature to be controlled by the digital input or device clock, use the HMI. |
| 00 | 02 | E001 0000 | 10 | 1, 2, 3, 4 | Set the active tariff: 1 = Rate A (tariff 1) 2 = Rate B (tariff 2) 3 = Rate C (tariff 3) 4 = Rate D (tariff 4) NOTE: You can only set the tariff using this method if the Tariff Mode is set to by Communication. |

Communications setup

| SND_UD code | Data format | Primary VIF | Range/Options | Description |
|-------------|-------------|-------------|---------------|-----------------|
| 00 | 01 | 7A | 0 – 250 | Primary address |

To change the baud rate via communications, send a telegram to the meter with the appropriate value in the CI-field:

| Baud rate | Hex value for CI-field |
|-----------|------------------------|
| 300 | B8 |
| 600 | B9 |
| 1200 | BA |
| 2400 | BB |
| 4800 | BC |
| 9600 | BD |

Digital input setup

NOTE: E denotes the extension bit; the hex value assumes E = 0.

| SND_UD code | Data format | Manufacturer specific VIFE | | Range/Options | Description |
|-------------|-------------|----------------------------|-----|---------------|--|
| | | bin | hex | | |
| 00 | 02 | E001 1011 | 1B | 0, 3, 5 | Digital input control mode: 0 = Normal (Input Status) 3 = Input metering 5 = Partial energy reset |
| 00 | 05 | E010 1111 | 2F | 1 – 10000 | Pulse constant (pulses/unit; applicable when the digital input is used for input metering) |

Digital output setup

NOTE: E denotes the extension bit; the hex value assumes E = 0.

| SND_UD code | Data format | Manufacturer specific VIFE | | Range/Options | Description |
|-------------|-------------|----------------------------|-----|---|---|
| | | bin | hex | | |
| 00 | 02 | E001 1010 | 1A | 2, 3, 0xFFFF | Digital output control mode: 2 = Alarm 3 = Energy (energy pulsing) 0xFFFF = Disable |
| 00 | 05 | E010 1110 | 2E | iEM3135 / iEM3335: 1, 10, 20, 100, 200, 1000 iEM3235: 0.01, 0.1, 1, 10, 100, 500 | Pulse constant NOTE: This information only applies if the digital output control mode is set to for Pulse. |
| 00 | 02 | E010 1100 | 2C | 50, 100, 200, 300 | Pulse width in ms NOTE: This information only applies if the digital output control mode is set to for Pulse. |

Overload alarm setup and acknowledgment

Use the information in the table below to configure the overload alarm.

NOTE: E denotes the extension bit; the hex value assumes E = 0.

| SND_UD code | Data format | Manufacturer specific VIFE | | Range/Options | Description |
|-------------|-------------|----------------------------|-----|---------------|--|
| | | bin | hex | | |
| 00 | 05 | E011 0101 | 35 | 0 – 9999999 | The pickup setpoint in kW for the overload alarm |
| 00 | 02 | E011 0100 | 34 | 0, 1 | Overload alarm setup: 0 = Disable 1 = Enable |

Use the information in the table below to acknowledge the overload alarm.

NOTE: E denotes the extension bit; the hex value assumes E = 1.

| SND_UD code | Data format | Manufacturer specific VIFE | | Range/Options | Description |
|-------------|-------------|----------------------------|-----|---------------|-------------------|
| | | bin | hex | | |
| 07 | 00 | E011 1000 | B8 | — | Acknowledge alarm |

Resets

NOTE: E denotes the extension bit; the hex value assumes E = 1.

| SND_UD code | Data format | Primary VIF | | Manufacturer specific VIFE | | Description |
|-------------|-------------|-------------|-----|----------------------------|-----|---|
| | | bin | hex | bin | hex | |
| 07 | 00 | — | — | E000 1101 | 8D | Resets partial energy accumulation to 0 |
| 07 | 00 | E110 0001 | E1 | — | — | Resets input accumulation to 0 |

M-Bus tool for data display and meter configuration

The M-Bus tool provides a graphical user interface where you can view meter data and configure meter settings. To obtain the tool, go to www.se.com and search for your meter model then select Downloads or contact your local Schneider Electric representative.

If you access a different meter without closing and re-opening the M-Bus tool, the fields displayed in the tool may not match the device you are accessing. The M-Bus tool may indicate a setting was changed without the setting on the meter actually changing.

NOTICE

INACCURATE DEVICE SETTINGS

Do not rely on the configuration information displayed in the M-Bus tool to determine if the associated device is correctly configured.

Failure to follow these instructions can result in inaccurate device settings and data results.

Installing the M-Bus tool

Before you install the tool, you need to download it from www.se.com or obtain it from your sales representative.

1. Navigate to the location where you saved the installation files.
2. Double-click setup.exe. A welcome screen appears. Click **Next**.

3. Confirm the installation location for the tool. Click **Browse** if you want to select a different location. Click **Next**. A confirmation screen appears.
4. Click **Next** to begin the installation. A screen appears when the installation is complete.
5. Click **Close**.

Accessing the meter using the tool

Before you access the meter using the M-Bus tool, make sure that you:

- Connect the meter to a level converter (for a direct serial connection) or a level converter and gateway (for connection via a serial or Ethernet network).
 - Set the address of the device to a value other than 0 (zero) using the HMI.
 - Install the M-Bus tool on your computer.
1. Select **Start > Programs > Schneider Electric > Mbus config tool** (or navigate to the location where you installed the program) and click **SE_iEM3135_3235_3335 Mbus Tool** to open the tool. The login screen appears.
 2. Select the port on your computer that you are using to connect to the meter and select the baud rate that matches the meter's configuration.
 3. Click **Test Com** to open the communications port.
 4. Type the device address in the **Address** field.
 5. Select the communications mode that you want the tool to start in:
 - **Monitor(Automatic)**: The tool automatically sends read requests to and receives data from the meter. You can set the interval at which these read requests are sent.
 - **Monitor(Manual)**: You must manually send a read request to get data from the meter.
 - **Config**: The tool opens in configuration mode.You can change the mode from within the tool, if needed.
 6. Click **OK** to start the M-Bus tool and access the meter.

Viewing meter data using the M-Bus tool

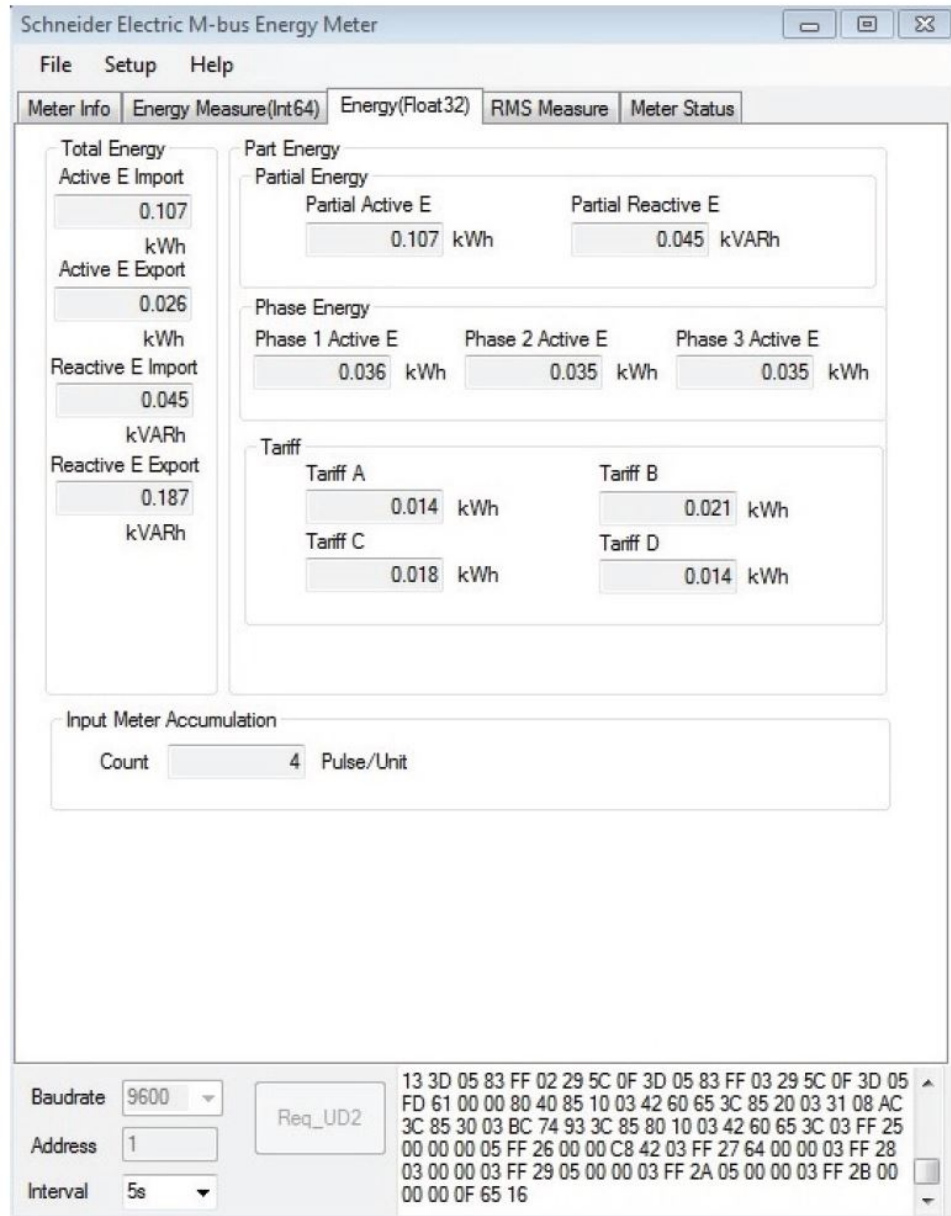

NOTE: The software version of M-Bus Meter Config tool is V3.0.

You can use two modes to view data from the device:

- Automatic mode: Select the update interval from the **Interval** dropdown list.
- Manual mode: Press **Req_UD2** to request data from the meter.

To switch modes, select **Setup > Monitor** then select the mode you want to use.

The tool has the following tabs for viewing meter information:

| Tab name | Description |
|----------------|--|
| Meter Info | This tab provides basic information about the meter (for example, model and serial number) and any active error codes. Click Clear to remove the error codes from the display. This does not resolve the errors. |
| Energy Measure | This tab provides total and partial energy, energy per phase and energy by tariff information, as well as input accumulations and the date and time of the last input metering and partial energy resets. |

| Tab name | Description |
|--------------|--|
| RMS Measure | This tab provides power, current, and voltage values as well as frequency and power factor information. |
| Meter Status | This tab provides information on the settings and status of the digital input, digital outputs and alarms as well as existing power system settings. |

Configuring the meter using the M-Bus tool

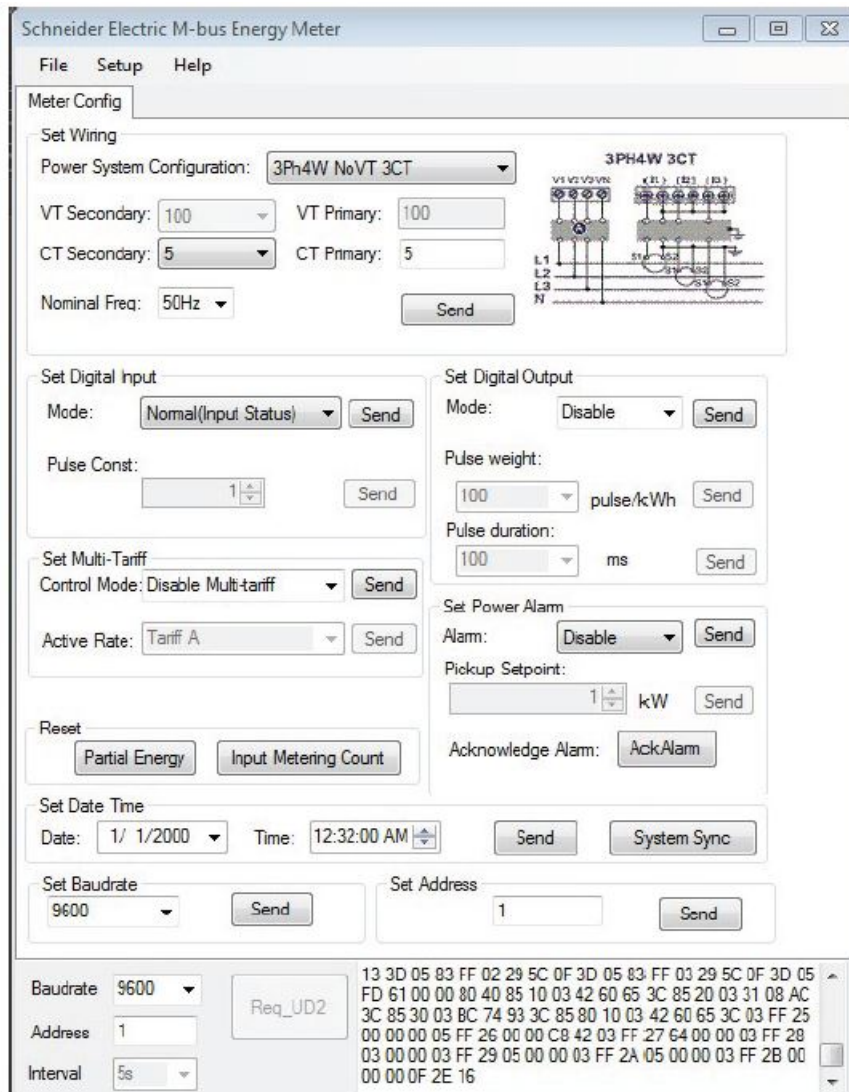

1. Select **Setup > Config** to switch to configuration mode.

2. Set the values that you want to change then click **Send** for that value or section. For example, to change the nominal frequency, select a different value from the list then click **Send** in **Set Wiring**.

Some values may be unavailable based on existing settings.

NOTE: If Com. Protection is enabled, you may receive a message that the configuration failed. Use the HMI to either: 1) configure the meter, or 2) disable Com. Protection then configure the meter using the tool.

The configuration screen has the following sections:

| Section | Description |
|--------------------|--|
| Set Wiring | Configure power system settings (for example, power system configuration and nominal frequency). |
| Set Digital Input | Set the digital input mode and pulse constant. |
| Set Digital Output | Enable / disable the digital output and set the control mode, pulse weight and duration. |
| Set Multi Tariff | Disable the Multi Tariff feature or set the control mode to by Communication and set the active tariff if the control mode is set to by Communication. |
| Set Power Alarm | Enable / disable to the overload alarm, enter the setpoint, and acknowledge alarms. |
| Reset | Reset partial energy and input metering accumulations. |
| Set Date Time | Set the date and time or send a time synchronization signal to set the meter to the computer time. |
| Set Baudrate | Set the baud rate. |
| Set Address | Set the meter address. |

Communications via BACnet

BACnet communications overview

Communications via BACnet MS/TP protocol is available on iEM3165 / iEM3265 / iEM3365 meter models.

The information in this section is intended for users with an advanced understanding of BACnet protocol, their communications network and their power system.

Key terms

| Term | Definition |
|---------------------------|---|
| APDU | Application protocol data unit, that data portion of a BACnet message. |
| Confirmed message | A message for which the device expects an answer. |
| COV | Change of value, sets the amount by which a value has to change in order for the meter to send a subscription notification. |
| Device | A BACnet device is a unit that is designed to understand and use BACnet protocol (for example, a BACnet-enabled meter or software program). It contains information about the device and device data in objects and object properties. Your meter is a BACnet device. |
| MS/TP | Master-slave/token-passing over RS-485. |
| Object | Represents the device and device data. Each object has a type (for example, analog input or binary input) and has a number of properties. |
| Present value | The current value of an object. |
| Property | The smallest piece of information in BACnet communications, it consists of a name, data type and value. |
| Service | Messages from one BACnet device to another. |
| Subscription | Creates a relationship between the server and the meter, so that when the present value property of an object changes by more than the configured COV threshold (COV_Increment), a notification is sent. |
| Subscription notification | The message the meter sends to indicate a COV event has occurred. |
| Unconfirmed message | A message for which the device does not expect an answer. |

BACnet protocol support

Go to www.se.com and search for your meter model to access the PICS (Protocol Implementation Conformance Statement) for your meter.

The meter supports the BACnet protocol as follows:

| BACnet component | Description |
|---|---|
| Protocol version | 1 |
| Protocol revision | 6 |
| Standardized device profile (Annex L) | BACnet Application Specific Controller (B-ASC) |
| BACNet Interoperability Building Blocks (Annex K) | DS-RP-B (Data Sharing - Read Property - B) |
| | DS-RPM-B (Data Sharing - Read Property Multiple - B) |
| | DS-WP-B (Data Sharing - Write Property - B) |
| | DS-COV-B (Data Sharing - COV - B) |
| | DM-DDB-B (Device Management - Dynamic Device Binding - B) |

| BACnet component | Description |
|-------------------------------|--|
| | DM-DOB-B (Device Management - Dynamic Object Binding - B) |
| | DM-DCC-B (Device Management - Device Communication Control - B) |
| Data link layer options | MS/TP master (clause 9) Baud rates 9600, 19200, 38400, 57600, 76800 |
| Character set | ANSI X3.4 |
| Supported services | subscribeCOV readProperty readPropertyMultiple writeProperty deviceCommunicationControl who-HAS who-Is I-Am I-Have Confirmed COV notification Unconfirmed COV notification |
| Segmentation | The meter does not support segmentation |
| Static device address binding | The meter does not support static device address binding |
| Networking options | None |

The following standard object types are supported:

| Object type | Optional properties supported | Writeable properties supported | Proprietary properties |
|---------------------|--|---|---------------------------|
| Device Object | Max_Master Max_Info_Frames Description Location Local_Date Local_Time Active_COV_Subscriptions Profile Name | Object_Name Max_Master Max_Info_Frames Description Location APDU_Timeout Number_Of_APDU_Retries | D_800 ID_801 ID_802 |
| Analog Input Object | COV_Increment | | — |
| Analog Value Object | — | | — |
| Binary Input Object | — | — | — |

BACnet communications implementation

Configuring basic communication parameters

Before communicating with the meter via BACnet protocol, use the front panel to configure the following settings:

| Setting | Possible values |
|-------------|--|
| Baud rate | 9600 19200 38400 57600 76800 |
| Mac Address | 1 – 127 |
| Device ID | 0 – 4194303 |

Make sure that the Mac Address is unique on the serial loop and the Device ID is unique in your BACnet network.

Communications LED indicator for BACnet meters

The LED indicates the status of the meter’s communications with the network.

| LED state | Description |
|---------------------|---|
| The LED is off | Communication is not active. |
| The LED is flashing | Communication is active. NOTE: The LED flashes even if there is a communications error. |

Change of Value (COV) subscriptions

The meter supports up to 14 COV subscriptions. You can add COV subscriptions to Analog Input and Binary Input objects using your BACnet-compatible software.

BACnet object and property information

The following sections outline the supported objects and properties available on the meter.

Device object

The following table outlines the properties of the Device object, whether a property is read-only or read-write, and if the value of the property is stored in the meter’s non-volatile onboard memory.

| Device object property | R/W | Stored | Possible values | Description |
|------------------------|-----|--------|--------------------|--|
| Object_Identifier | R | — | configurable | The unique device ID number for the meter, in the format of <device, #>. NOTE: You must use the front panel to configure the device ID number. |
| Object_Name | R/W | √ | configurable | A configurable name for the meter. The meter ships from the factory with a name of <model name>_<serial number> (for example, _0000000000). |
| Object_Type | R | — | Device | The object type for the meter. |
| System_Status | R | — | Operational | This value of this property is always Operational. |
| Vendor_Name | R | — | Schneider Electric | Meter manufacturer |
| Vendor_Identifier | R | — | 10 | The BACnet vendor identifier for Schneider Electric. |

| Device object property | R/W | Stored | Possible values | Description |
|---------------------------------|-----|--------|---|--|
| Model_Name | R | — | iEM3165 / iEM3265 / iEM3365 | Device model (for example, iEM3265) and serial number in the format <model name> <serial number> (for example, iEM3265_0000000000). |
| Firmware_Revision | R | — | varies | BACnet firmware version, stored in an x.x.x format (for example, 1.7.2). |
| Application_Software_Version | R | — | varies | Meter firmware version, stored in an x.x.xxx format (for example, 1.0.305). |
| Description | R/W | √ | configurable | Optional description of the meter, limited to 64 characters. |
| Location | R/W | √ | configurable | Optional description of the meter's location, limited to 64 characters. |
| Protocol_Version | R | — | varies | BACnet protocol version (for example, version 1) |
| Protocol_Revision | R | — | varies | BACnet protocol revision (for example, revision 6) |
| Protocol_Services_Supported | R | — | 0000 0100 0000 1011 0100 0000 0000 0000 0110 0000 | The BACnet services supported by the meter: subscribeCOV, readProperty, readPropertyMultiple, writeProperty, deviceCommunicationControl, who- HAS, who-Is |
| Protocol_Object_Types_Supported | R | — | 1011 0000 1000 0000 0000 0000 0000 0000 | The BACnet object types supported by the meter: analog input, binary input, multi-state input, device. |
| Object_list | R | — | varies | List of objects in the meter: iEM3165 / iEM3365: DE1, AI0 – AI48, AV0, BI0 – BI6 iEM3265: DE1, AI0 – AI55, AV0, BI0 – BI6 |
| Max_APDU_Length_Accepted | R | — | 480 | The maximum packet size (or application protocol data unit) that the meter can accept, in bytes. |
| Segmentation_Supported | R | — | 0x03 | The meter does not support segmentation. |
| Local_Date | R | — | configurable | Date NOTE: You must use the front panel to set the meter's date. |
| Local_Time | R | — | configurable | Time NOTE: You must use the front panel to set the meter's date. |
| APDU_Timeout | R/W | √ | 1000 – 30000 | The amount of time (in milliseconds) before the meter tries to resend a confirmed message that has not been answered. |
| Number_Of_APDU_Retries | R/W | √ | 1 – 10 | The number of times the meter tries to resend an unanswered confirmed request. |
| Max_Master | R/W | √ | 1 – 127 | The highest master address the meter will try to discover when the next node is unknown. |
| Max_Info_Frames | R/W | √ | 1 – 14 | Maximum number of messages the meter can send before it must pass the token. |
| Device_Address_Binding | R | — | — | Device address binding table is always blank because the meter does not initiate the who-Is service. |
| Database_Revision | R | √ | varies | A number that increments when the object database on the meter changes (for example, when an object is created or deleted or the ID of an object changes). |
| Active_COV_Subscriptions | R | — | varies | List of COV subscriptions currently active on the meter. |
| Profile_Name | R | — | varies | Device identifier that records the meter manufacturer, the meter family and the specific |

| Device object property | R/W | Stored | Possible values | Description |
|------------------------|-----|--------|-----------------|---|
| | | | | meter model (for example, 10_iEM3000_iEM3265). |
| ID 800 | R | — | varies | Date and time of last energy reset |
| ID 801 | R | — | varies | Date and time of last input metering accumulation reset |
| ID 802 | R | — | varies | Date and time of the last alarm (DD/MM/YYYY hh:mm:ss) |

Analog Input objects

The following tables list the Analog Input (AI) objects along with the units and default COV value for each AI object (if applicable).

NOTE: The Value Type for all AI objects is Real.

Energy and energy by tariff measurements

The energy and energy by tariff measurements listed below are preserved through power failures.

| Object ID | Units | Default COV | Object name / description |
|-----------|-------|-------------|--|
| 27 | Wh | 100 | AI27 - Total active energy import |
| 28 | Wh | 100 | AI28 - Total active energy export |
| 29 | Wh | 100 | AI29 - Total reactive energy import |
| 30 | Wh | 100 | AI30 - Total reactive energy export |
| 31 | Wh | 100 | AI31 - Partial active energy import |
| 32 | Wh | 100 | AI32 - Partial reactive energy import |
| 33 | Wh | 100 | AI33 - Active energy import phase 1 |
| 34 | Wh | 100 | AI34 - Active energy import phase 2 |
| 35 | Wh | 100 | AI35 - Active energy import phase 3 |
| 36 | — | 10 | AI36 - Accumulation Input metering accumulation |
| 37 | — | 1 | AI37 - Tariff Energy Active Rate Denotes the active tariff: 0 = Multi Tariff feature is disabled 1 = Rate A (tariff 1) active 2 = Rate B (tariff 2) active 3 = Rate C (tariff 3) active 4 = Rate D (tariff 4) active |
| 38 | Wh | 100 | AI38 - Rate A (Tariff 1) active energy import |
| 39 | Wh | 100 | AI39 - Rate B (Tariff 2) active energy import |
| 40 | Wh | 100 | AI40 - Rate C (Tariff 3) active energy import |
| 41 | Wh | 100 | AI41 - Rate D (Tariff 4) active energy import |

Instantaneous (RMS) measurements

| Object ID | Units | Default COV | Object name / description |
|-----------|-------|-------------|-----------------------------|
| 7 | A | 50 | AI07 - Current Phase 1 |
| 8 | A | 50 | AI08 - Current Phase 2 |
| 9 | A | 50 | AI09 - Current Phase 3 |
| 10 | A | 50 | AI10 - Current Average |
| 11 | V | 10 | AI11 - Voltage L1-L2 |
| 12 | V | 10 | AI12 - Voltage L2-L3 |
| 13 | V | 10 | AI13 - Voltage L3-L1 |
| 14 | V | 10 | AI14 - Voltage Average L-L |
| 15 | V | 10 | AI15 - Voltage L1-N |
| 16 | V | 10 | AI16 - Voltage L2-N |
| 17 | V | 10 | AI17 - Voltage L3-N |
| 18 | V | 10 | AI18 - Voltage Average L-N |
| 19 | kW | 10 | AI19 - Active Power Phase 1 |
| 20 | kW | 10 | AI20 - Active Power Phase 2 |
| 21 | kW | 10 | AI21 - Active Power Phase 3 |
| 22 | kW | 10 | AI22 - Active Power Total |
| 23 | kVAR | | AI23 - Reactive Power Total |
| 24 | kVA | 10 | AI24 - Apparent Power Total |
| 25 | — | 0.2 | AI25 - Power Factor Total |
| 26 | Hz | 10 | AI26 - Frequency |

Meter information

The following AI objects display information about the meter and its configuration.

NOTE: You can access the meter's configuration information over BACnet communications. However, you must use the front panel to configure the meter's settings.

| Object ID | Units | Default COV | Object name / description |
|-----------|---------|-------------|---|
| 44 | Seconds | 10 | AI44 - Meter operation time The time in seconds since the meter was last powered up |
| 45 | — | 1 | AI45 - Number of phases 1, 3 |
| 46 | — | 1 | AI46 - Number of wires 2, 3, 4 |
| 47 | — | 1 | AI47 - Power system type 0 = 1PH2W L-N 1 = 1PH2W L-L 2 = 1PH3W L-L with N 3 = 3PH3W 11 = 3PH4W 13 = 1PH4 wire multi L-N |
| 48 | Hz | 1 | AI48 - Nominal frequency 50, 60 |
| 49 | — | 1 | AI49 - Number of VTs |

| Object ID | Units | Default COV | Object name / description |
|-----------|-------|-------------|---|
| | | | 0 – 10 NOTE: Applicable only for iEM3265 |
| 50 | V | 1 | AI50 - VT Primary NOTE: Applicable only for iEM3265 |
| 51 | V | 1 | AI51 - VT Secondary NOTE: Applicable only for iEM3265 |
| 52 | — | 1 | AI52 - Number of CTs 1, 2, 3 NOTE: Applicable only for iEM3265 |
| 53 | A | 1 | AI53 - CT Primary NOTE: Applicable only for iEM3265 |
| 54 | A | 1 | AI54 - CT Secondary NOTE: Applicable only for iEM3265 |
| 55 | — | 1 | AI55 - VT connection type 0 = Direct connection, not VTs 1 = 3PH3W (2VTs) 2 = 3PH4W (3VTs) |

Communications settings information

The following AI objects display information about the meter’s communications settings.

NOTE: You can access the meter’s communications configuration information over BACnet communications. However, you must use the front panel to configure the meter’s settings.

| Object ID | Units | Default COV | Object name / description |
|-----------|-------|-------------|---------------------------|
| 00 | — | 1 | AI00 - BACnet MAC Address |
| 01 | — | 1 | AI01 - BACnet Baud Rate |

Digital input and output setting information

The following AI objects display information about the meter’s I/O settings.

NOTE: You can access the meter’s I/O configuration information over BACnet communications. However, you must use the front panel to configure the meter’s settings.

| Object ID | Units | Default COV | Object name / description |
|-----------|-------|-------------|---|
| 02 | ms | 1 | AI02 - Pulse Duration The energy pulse duration (or pulse width), in milliseconds, of the digital output. NOTE: This information only applies if the digital output mode is set to energy pulsing. |
| 03 | — | 1 | AI03 - Pulse Weight The pulses/unit setting of the digital input when it is configured for input metering. NOTE: This information only applies if the digital input mode is set to Input Metering. |
| 04 | — | 1 | AI04 - Pulse Constant The pulses/kWh setting of the digital output. NOTE: This information only applies if the digital output mode is set to energy pulsing. |

| Object ID | Units | Default COV | Object name / description |
|-----------|-------|-------------|---|
| 05 | — | 1 | AI05 - Digital Input Mode 0 = Normal (input status) 2 = Multi Tariff control 3 = Input metering 5 = All partial energy logs reset |
| 06 | — | 1 | AI06 - Digital Output Mode 2 = Alarm 3 = Energy 0xFFFF (65535 dec) = Disabled |
| 42 | kW | 10 | AI42 - Pickup Setpoint Active power alarm pickup setpoint in kW |
| 43 | kW | 10 | AI43 - Last Alarm Value |

Analog value object

There is one Analog Value (AV) object available on the meter, named AV00 - Command. The available commands are listed in the following table. Enter the number in the Present_Value column in the Present_Value property of the AV object to write the associated command to the meter.

| Command | Present_Value entry | Object name / description |
|------------------------------|---------------------|--|
| Acknowledge Overload Alarm | 20001.00 | Acknowledge an overload alarm. The alarm indicator disappears from the front panel display after you acknowledge the alarm; however, this does not address the state that caused the alarm. |
| Reset Partial Energy Counter | 2020.00 | Reset partial energy accumulation to 0. Partial Active / Reactive Energy, Energy by Tariff and Phase Energy registers are reset. |
| Reset Input Metering Counter | 2023.00 | Resets input metering accumulation to 0. |

Binary input objects

The following table lists the Binary Input (BI) objects available on the meter.

NOTE: The value type for all BI objects is Boolean.

| Object ID | Object name / description |
|-----------|--|
| 0 | BI00 - Digital Output Enable Indicates whether or not the digital output functions as an energy pulse output: 0 = Digital output disabled 1 = Digital output is associated with active energy pulse output |
| 1 | BI01 - Digital Input Association Enable Indicates whether or not the digital input is associated with input metering: 0 = Digital input is not associated with input metering 1 = Digital input is associated with input metering |
| 2 | BI02 - Digital Input Status 0 = relay open 1 = relay closed NOTE: This information only applies if the digital input is set to Input Status. |
| 3 | BI03 - Alarm Enable |

| Object ID | Object name / description |
|-----------|--|
| | Indicates whether the overload alarm is enabled or disabled: 0 = disabled 1 = enabled |
| 4 | BI04 - Digital Output Association Enable Indicates if the digital output is configured for alarming: 0 = digital output disabled 1 = for Alarm (digital output is associated with the overload alarm) |
| 5 | BI05 - Alarm Status 0 = Alarm is inactive 1 = Alarm is active |
| 6 | BI06 - Unacknowledged status 0 = historic alarm is acknowledged 1 = historic alarm is unacknowledged |

Power, energy and power factor

Power (PQS)

A typical AC electrical system load has both resistive and reactive (inductive or capacitive) components. Resistive loads consume real power (P) and reactive loads consume reactive power (Q).

Apparent power (S) is the vector sum of real power (P) and reactive power (Q):

$$S = \sqrt{P^2 + Q^2}$$

Real power is measured in watt (W or kW), reactive power is measured in var (VAR or kVAR) and apparent power is measured in volt-amp (VA or kVA).

Power and the PQ coordinate system

The meter uses the values of real power (P) and reactive power (Q) on the PQ coordinate system to calculate apparent power.

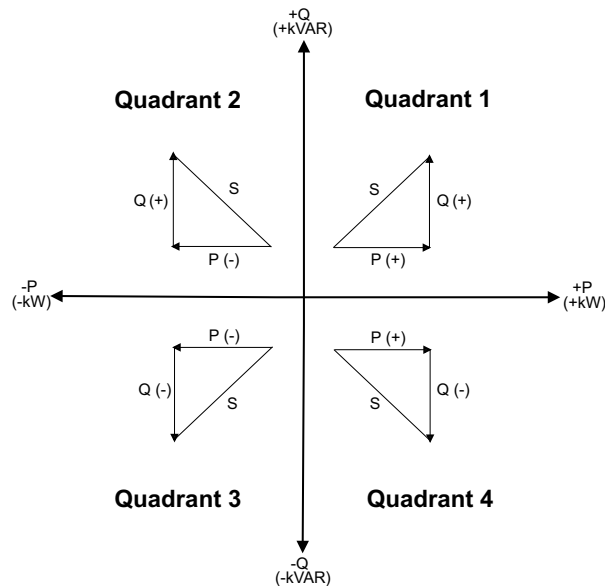

Power flow

Positive power flow P(+) and Q(+) means power is flowing from the power source towards the load. Negative power flow P(-) and Q(-) means power is flowing from the load towards the power source.

Energy delivered (imported) / energy received (exported)

The meter interprets energy delivered (imported) or received (exported) according to the direction of real power (P) flow.

Energy delivered (imported) means positive real power flow (+P) and energy received (exported) means negative real power flow (-P).

| Quadrant | Real (P) power flow | Energy delivered (imported) or received (exported) |
|------------|---------------------|--|
| Quadrant 1 | Positive (+) | Energy delivered (imported) |
| Quadrant 2 | Negative (-) | Energy received (exported) |
| Quadrant 3 | Negative (-) | Energy received (exported) |
| Quadrant 4 | Positive (+) | Energy delivered (imported) |

Power factor (PF)

Power factor (PF) is the ratio of real power (P) to apparent power (S).

PF is provided as a number between -1 and 1 or as a percentage from -100% to 100%, where the sign is determined by the convention.

$$PF = \frac{P}{S}$$

A purely resistive load has no reactive components, so its power factor is 1 (PF = 1, or unity power factor). Inductive or capacitive loads introduce a reactive power (Q) component to the circuit which causes the PF to become closer to zero.

True PF

True power factor includes harmonic content.

PF lead / lag convention

The meter correlates leading power factor (PF lead) or lagging power factor (PF lag) with whether the current waveform is leading or lagging the voltage waveform.

Current phase shift from voltage

For purely resistive loads the current waveform is in phase with the voltage waveform. For capacitive loads, current leads voltage. For inductive loads, current lags voltage.

Current lead / lag and load type

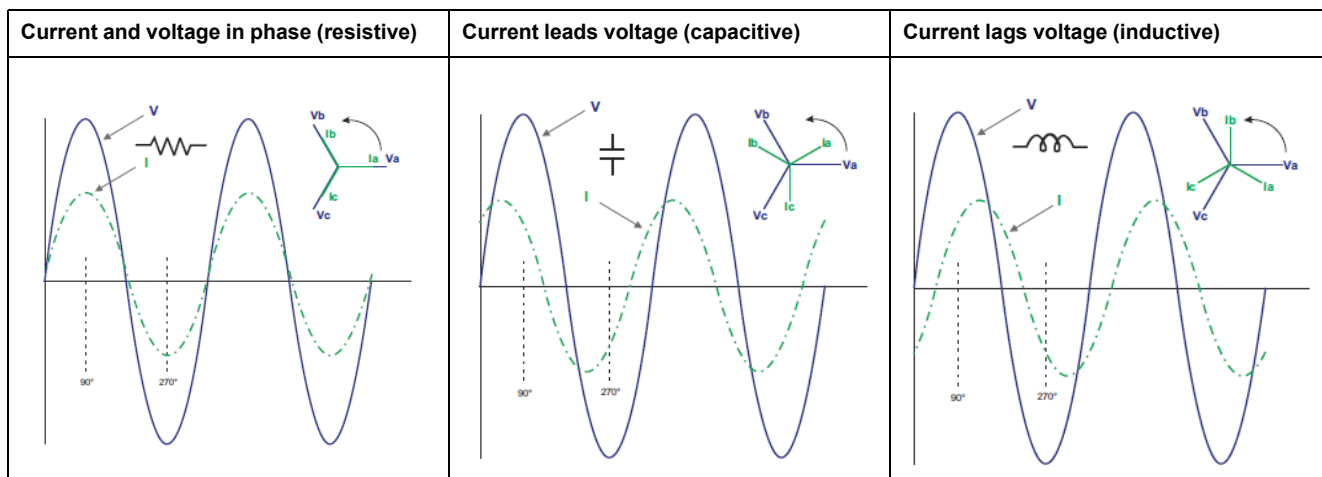

Power and PF lead / lag

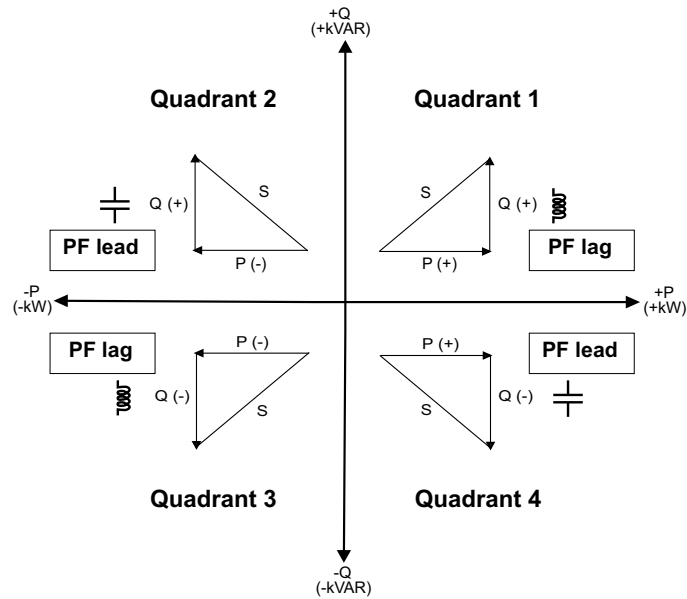

PF lead / lag summary

NOTE: The lagging or leading distinction does **NOT** equate to a positive or negative value. Rather, lagging corresponds to an inductive load, while leading corresponds to a capacitive load.

| Quadrant | Current phase shift | load type | |
|------------|-----------------------|------------|---------|
| Quadrant 1 | Current lags voltage | Inductive | PF lag |
| Quadrant 2 | Current leads voltage | Capacitive | PF lead |
| Quadrant 3 | Current lags voltage | Inductive | PF lag |
| Quadrant 4 | Current leads voltage | Capacitive | PF lead |

PF sign convention

The meter shows positive or negative power factor according to IEC standards.

PF sign in IEC

The meter correlates power factor sign (PF sign) with the direction of real power (P) flow.

- For positive real power (+P), the PF sign is positive (+).
- For negative real power (-P), the PF sign is negative (-).

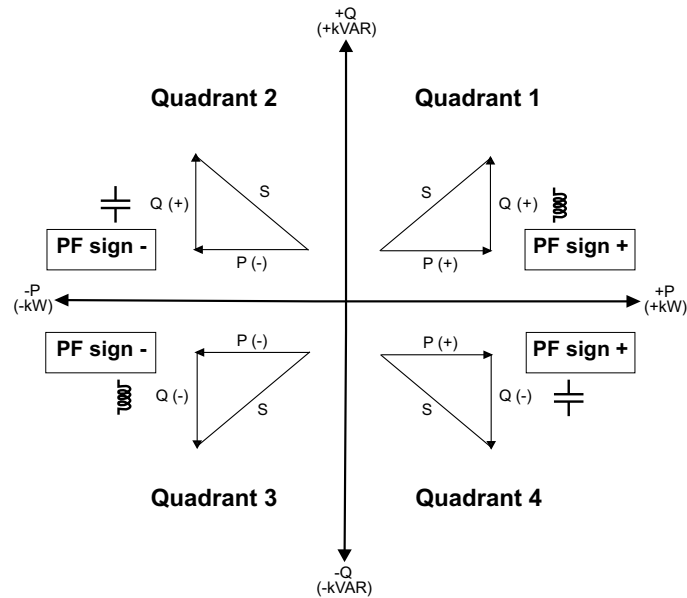

Power factor register format

The meter performs a simple algorithm to the PF value then stores it in the PF register.

Each power factor value (PF value) occupies one floating point register for power factor (PF register). The meter and software interpret the PF register for all reporting or data entry fields according to the following diagram:

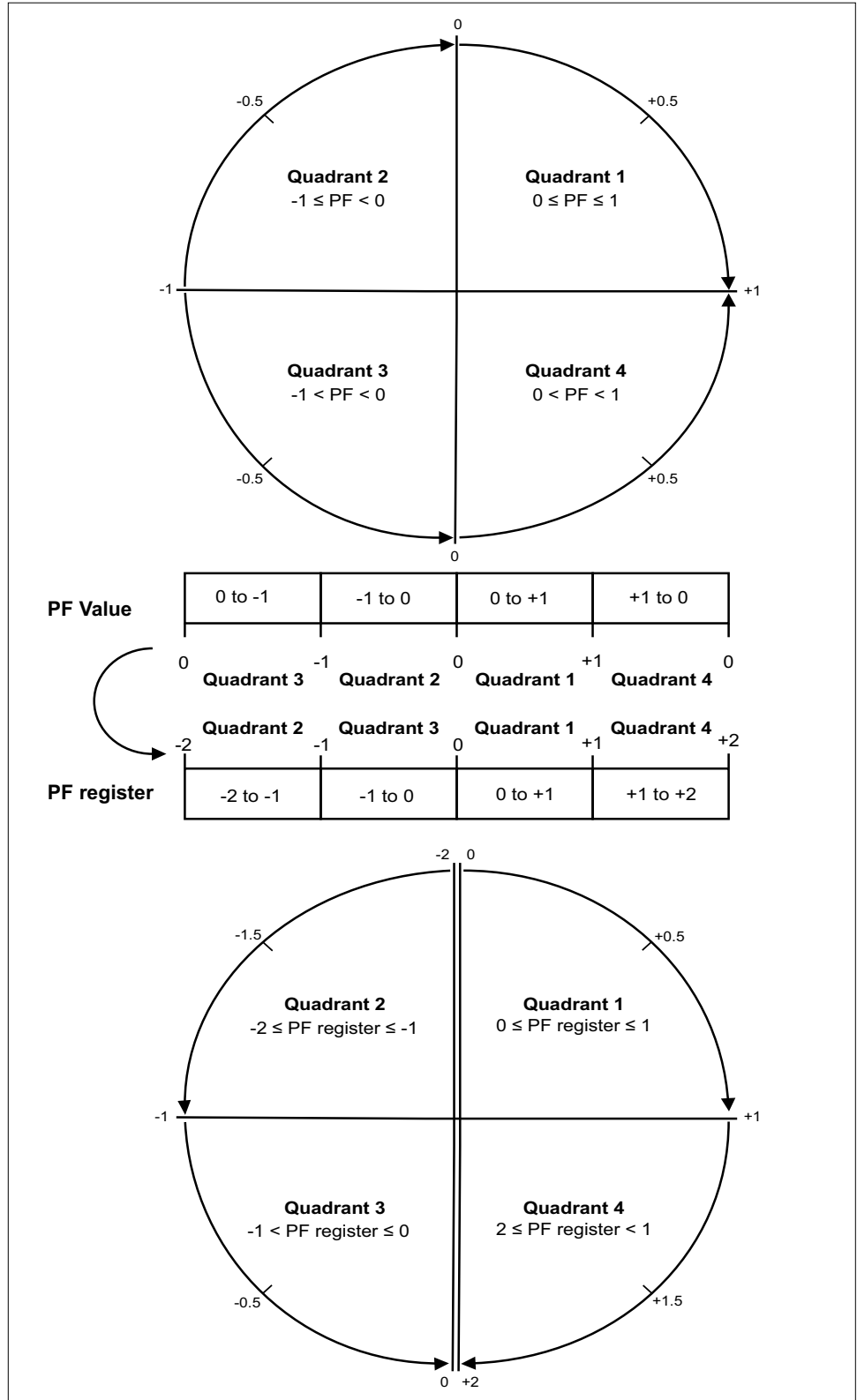

The PF value is calculated from the PF register value using the following formulae:

| Quadrant | PF range | PF register range | PF formula |
|------------|----------|-------------------|---------------------------------------|
| Quadrant 1 | 0 to +1 | 0 to +1 | PF value = PF register value |
| Quadrant 2 | -1 to 0 | -2 to -1 | PF value = (-2) - (PF register value) |
| Quadrant 3 | 0 to -1 | -1 to 0 | PF value = PF register value |
| Quadrant 4 | +1 to 0 | +1 to +2 | PF value = (+2) - (PF register value) |

Troubleshooting

Overview

The meter does not contain any user-serviceable parts. If the meter requires service, contact your local Schneider Electric representative.

| |
|---|
| NOTICE |
| <p>RISK OF DAMAGE TO THE METER</p> <ul style="list-style-type: none"> • Do not open the meter case. • Do not attempt to repair any components of the meter. <p>Failure to follow these instructions can result in equipment damage.</p> |

Do not open the meter. Opening the meter voids the warranty.

Diagnosis screen

The Diagnosis screen lists any current diagnostic codes.

NOTE: The Diagnosis screen only appears if there is a specific event.

| | | | | | |
|---|---|---|-----------------|---|-----------------|
| <div style="border: 1px solid black; padding: 5px; display: inline-block;"> <p>Diagnosis</p> <p style="text-align: right;">201</p> <p>T1 23-Apr-2012 1/2</p> </div> | <table border="1" style="width: 100%; border-collapse: collapse;"> <tr> <td style="width: 10%; text-align: center;">A</td> <td>Diagnostic code</td> </tr> <tr> <td style="text-align: center;">B</td> <td>Existing events</td> </tr> </table> | A | Diagnostic code | B | Existing events |
| A | Diagnostic code | | | | |
| B | Existing events | | | | |

1. Press the down button to scroll through the main display screens until you reach the **Diagnosis** screen.
2. Press the button to scroll through any existing events.

Diagnostic codes

If the combination of the backlight and the error / alert icon indicates an error or an abnormal situation, navigate to the diagnostics screen and find the diagnostics code. If the problem persists after following the instructions in the table, please contact Technical Support.

| Diagnostic code ¹ | Description | Possible solution |
|------------------------------|--|--|
| — | LCD display is not visible. | Check and adjust LCD contrast. |
| — | Push buttons do not respond. | Restart the meter by powering off and powering on again. |
| 101 | Metering stops due to an EEPROM error. Press OK to display total energy consumption. | Enter configuration mode and select Reset Config. |
| 102 | Metering stops due to a lack of a calibration table. Press OK to display total energy consumption. | Enter configuration mode and select Reset Config. |
| 201 | Metering continues. | Correct the frequency settings according to the nominal frequency of the power system. |

¹ Not all diagnostic codes apply to all devices.

| Diagnostic code ² | Description | Possible solution |
|------------------------------|--|---|
| | Mismatch between frequency settings and frequency measurements. | |
| 202 | Metering continues. Mismatch between wiring settings and wiring inputs. | Correct the wiring settings according to wiring inputs. |
| 203 | Metering continues. Phase sequence reversed. | Check the wire connections and correct the wiring settings if needed. |
| 204 | Metering continues. Total active energy is negative due to incorrect voltage and current connections. | Check the wire connections and correct the wiring settings if needed. |
| 205 | Metering continues. Date and Time have been reset due to a loss of power. | Set the Date and Time. |
| 206 | Metering continues. Pulse is missing due to overload on energy pulse output. | Check the energy pulse output settings and correct if needed. |
| 207 | Metering continues. Abnormal internal clock function. | Restart the meter by powering off and powering on again then reset the date and time. |

2. Not all diagnostic codes apply to all devices.

Specifications

Electrical characteristics

Power system inputs: iEM3100 series

| Characteristic | Value |
|--|---|
| Measured voltage | Wye: 100...277 V L-N, 173...480 V L-L $\pm 20\%$ Delta: 173...480 V L-L $\pm 20\%$ |
| Maximum current | 63 A |
| Measured current | 0.5 A to 63 A |
| Overload | 332 V L-N or 575 V L-L |
| Voltage impedance | 3 M Ω |
| Current impedance | < 0.3 m Ω |
| Frequency | 50 / 60 Hz $\pm 10\%$ |
| Measurement category | III |
| Minimum wire temperature rating required | 90 °C (194 °F) |
| Burden | < 10 VA at 63 A |
| Wire | 16 mm ² / 6 AWG (Recommended: Copper wire with a compatible copper lug) |
| Wire strip length | 11 mm / 0.43 in |
| Torque | 1.8 Nm / 15.9 in·lb |
| Withstand | 63 A continuous, 160 A at 10 sec/hr |
| Impulse voltage (Uimp) | 6 kV for 1.2 μ s |
| Utilization category | UC1 |

Power system inputs: iEM3300 series

| Characteristic | Value |
|--|---|
| Measured voltage | Wye: 100...277 V L-N, 173...480 V L-L $\pm 20\%$ Delta: 173...480 V L-L $\pm 20\%$ |
| Maximum current | 125 A |
| Measured current | 1 A to 125 A |
| Overload | 332 V L-N or 575 V L-L |
| Voltage impedance | 6 M Ω |
| Current impedance | < 0.2 m Ω |
| Frequency | 50 / 60 Hz $\pm 10\%$ |
| Measurement category | III |
| Minimum wire temperature rating required | 105 °C (221 °F) |
| Burden | < 10 VA at 125 A |
| Wire | 50 mm ² / 1 AWG (Recommended: Copper wire with a compatible copper lug) |
| Wire strip length | 13 mm / 0.5 in |

| Characteristic | Value |
|----------------------|--------------------------------------|
| Torque | 3.5 Nm / 30.9 in·lb |
| Withstand | 125 A continuous, 320 A at 10 sec/hr |
| Impulse voltage | 6 kV for 1.2 μs |
| Utilization category | UC3 |

Power system inputs: iEM3200 series

| Characteristic | | Value |
|----------------|--|---|
| Voltage inputs | Measured voltage | Wye: 100...277 V L-N, 173...480 V L-L ±20% Delta: 173...480 V L-L ±20% |
| | Overload | 332 V L-N or 575 V L-L |
| | Impedance | 3 MΩ |
| | Impulse voltage (Uimp) | 6 kV for 1.2 μs |
| | Frequency | 50 / 60 Hz ±10% |
| | Measurement category | III |
| | Minimum wire temperature rating required | 90 °C (194 °F) |
| | Burden | < 10 VA |
| | Wire | 2.5 mm ² / 14 AWG (Recommended: Copper wire) |
| | Wire strip length | 8 mm / 0.31 in |
| | Torque | 0.5 Nm / 4.4 in·lb |
| Current inputs | Nominal current | 1 A or 5 A |
| | Measured current | 20 mA to 6 A |
| | Withstand | 10 A continuous, 20 A at 10 sec/hr |
| | Minimum wire temperature rating required | 90 °C (194 °F) |
| | Impedance | < 1 mΩ |
| | Frequency | 50 / 60 Hz ±10% |
| | Burden | < 0.036 VA at 6 A |
| | Wire | 6 mm ² / 10 AWG (Recommended: Copper wire) |
| | Wire strip length | 8 mm / 0.31 in |
| | Torque | 0.8 Nm / 7.0 in·lb |

Inputs and outputs

| Characteristic | | Value | Meters |
|-----------------------------|----------------------|-------------|---|
| Programmable digital output | Number | 1 | iEM3135 / iEM3155 / iEM3165 / iEM3235 / iEM3255 / iEM3265 / iEM3335 / iEM3355 / iEM3365 |
| | Type | Form A | |
| | Load voltage | 5...40 V DC | |
| | Maximum load current | 50 mA | |
| | Output resistance | 0.1...50 Ω | |

| Characteristic | | Value | Meters | |
|----------------------------|-------------------|--|---|---|
| | Isolation | 3.75 kV rms | | |
| | Wire | 1.5 mm ² / 16 AWG | | |
| | Wire strip length | 6 mm / 0.23 in | | |
| | Torque | 0.5 Nm / 4.4 in·lb | | |
| Pulse output | Number | 1 | iEM3110 / iEM3210 / iEM3310 | |
| | Pulses / kWh | Configurable | | |
| | Voltage | 5...30 V DC | | |
| | Current | 1...15 mA | | |
| | Pulse width | Configurable Minimum width is 50 ms | | |
| | Isolation | 3.75 kV rms | | |
| | Wire | 2.5 mm ² / 14 AWG | | |
| | Wire strip length | 7 mm / 0.28 in | | |
| | Torque | 0.5 Nm / 4.4 in·lb | | |
| Programmable digital input | Number | 2 | iEM3115 / iEM3215 | |
| | | 1 | iEM3135 / iEM3155 / iEM3165 / iEM3175 / iEM3235 / iEM3255 / iEM3265 / iEM3275 / iEM3335 / iEM3355 / iEM3365 / iEM3375 | |
| | Type | Type 1 (BS/ EN/ IEC 61131-2) | | |
| | Maximum input | Voltage | 40 V DC | iEM3115 / iEM3135 / iEM3155 / iEM3165 / iEM3175 / iEM3215 / iEM3235 / iEM3255 / iEM3265 / iEM3275 / iEM3335 / iEM3355 / iEM3365 / iEM3375 |
| | | Current | 4 mA | |
| | Voltage OFF | | 0...5 V DC | |
| | Voltage ON | | 11...40 V DC | |
| | Nominal voltage | | 24 V DC | |
| | Isolation | | 3.75 kV rms | |
| | Wire | | 1.5 mm ² / 16 AWG | |
| | Wire strip length | | 6 mm / 0.23 in | |
| | Torque | | 0.5 Nm / 4.4 in·lb | |

Mechanical characteristics

| Characteristic | Value | | Meters |
|---|--|------|------------------------------------|
| IP degree of protection | Front panel | IP40 | iEM3100 / iEM3200 / iEM3300 series |
| | Meter body | IP20 | iEM3100 / iEM3200 series |
| | Meter body except bottom wiring surface | IP20 | iEM3300 series |
| Impact rating | IK08 | | iEM3100 / iEM3200 / iEM3300 series |
| Active energy display range | In kWh or MWh up to 99999999 MWh | | iEM3200 series |
| | In kWh: 8 + 1 digits up to 99999999.9 | | iEM3100 / iEM3300 series |
| Energy pulsing LED (yellow ²) | 500 imp/k(W/VAR)h | | iEM3100 series |
| | 5000 imp/k(W/VAR)h without consideration of transformer ratios | | iEM3200 series |
| | 200 imp/k(W/VAR)h | | iEM3300 series |

2. The pulses / kWh of the energy pulsing LED cannot be changed.

Environmental characteristics

| Characteristic | Value |
|-----------------------|---|
| Operating temperature | -25 to 70 °C (-13 to 158 °F) |
| Storage temperature | -40 to 85 °C (-40 to 185 °F) |
| Pollution degree | 2 |
| Relative humidity | 5% to 95% RH non-condensing Maximum dew point 36 °C (97 °F) |
| Altitude | < 3000 m (9842 ft) above sea level |
| Location | For indoor use in a stationary panel Must be permanently connected and fixed |
| Product life | > 15 years, 45 °C (113 °F) 60% RH |

Safety, EMI/EMC and product standards

| | | |
|---------------------|--|--|
| Safety | BS/ EN/ IEC/ UL 61010-1: 2010 + A1: 2019 | |
| Protective class | II Double insulated for user accessible parts | |
| Standard compliance | IEC 62052-31: 2015 IEC 62052-11: 2020 IEC 62053-21: 2020 IEC 62053-22: 2020 IEC 62053-23: 2020 IEC 61557-12: 2021 | BS/ EN 62052-31 BS/ EN 62052-11 BS/ EN 62053-21 BS/ EN 62053-22 BS/ EN 62053-23 BS/ EN 61557-12 BS/ EN 50470-1 BS/ EN 50470-3 |

Measurement accuracy

| Characteristic | | Value | Meters |
|------------------------|-----------------|---|---|
| 63 A | Active energy | Class 1 conforming to BS/ EN/ IEC 62053-21 and BS/ EN/ IEC 61557-12 (PMD DD): $I_{max}=63$ A, $I_b=10$ A, and $I_{st}=0.04$ A | iEM3100 series |
| | | Class B conforming to BS/ EN 50470-3: $I_{max}=63$ A, $I_{ref}=10$ A, $I_{min}=0.5$ A, and $I_{st}=0.04$ A | iEM3110 / iEM3115 / iEM3135 / iEM3155 / iEM3165 / iEM3175 |
| | Reactive energy | MID compliance, Class 2 conforming to BS/ EN/ IEC 62053-23 and BS/ EN/ IEC 61557-12 (PMD DD): $I_{max}=63$ A, $I_b=10$ A, and $I_{st}=0.05$ A | iEM3135 / iEM3155 / iEM3165 / iEM3175 |
| 125 A | Active energy | Class 1 conforming to BS/ EN/ IEC 62053-21 and BS/ EN/ IEC 61557-12 (PMD DD): $I_{max}=125$ A, $I_b=20$ A, and $I_{st}=0.08$ A | iEM3300 series |
| | | Class B conforming to BS/ EN 50470-3: $I_{max}=125$ A, $I_{ref}=20$ A, $I_{min}=1$ A, and $I_{st}=0.08$ A | iEM3310 / iEM3335 / iEM3355 / iEM3365 / iEM3375 |
| | Reactive energy | MID compliance, Class 2 conforming to BS/ EN/ IEC 62053-23 and BS/ EN/ IEC 61557-12 (PMD DD): $I_{max}=125$ A, $I_b=20$ A, and $I_{st}=0.1$ A | iEM3335 / iEM3355 / iEM3365 / iEM3375 |
| for x/1A current input | Active energy | Class 1 conforming to BS/ EN/ IEC 62053-21 and BS/ EN/ IEC 61557-12 (PMD SD / PMD Sx): $I_{max}=1.2$ A, $I_n=1$ A, and $I_{st}=0.002$ A | iEM3200 series |

| Characteristic | | Value | Meters |
|------------------------|-----------------|--|---|
| | | Class B conforming to BS/ EN 50470-3: $I_{max}=1.2$ A, $I_n=1$ A, $I_{min}=0.01$ A, and $I_{st}=0.002$ A | iEM3210 / iEM3215 / iEM3235 / iEM3255 / iEM3265 / iEM3275 |
| | Reactive energy | MID compliance, Class 2 conforming to BS/ EN/ IEC 62053-23 and BS/ EN/ IEC 61557-12 (PMD Sx): $I_{max}=1.2$ A, $I_n=1$ A, and $I_{st}=0.003$ A | iEM3235 / iEM3255 / iEM3265 / iEM3275 |
| for x/5A current input | Active energy | Class 0.5S conforming to BS/ EN/ IEC 62053-22 and BS/ EN/ IEC 61557-12 (PMD SD / PMD Sx): $I_{max}=6$ A, $I_n=5$ A, and $I_{st}=0.005$ A | iEM3200 series |
| | | Class C conforming to BS/ EN 50470-3: $I_{max}=6$ A, $I_n=5$ A, $I_{min}=0.05$ A, and $I_{st}=0.005$ A | iEM3210 / iEM3215 / iEM3235 / iEM3255 / iEM3265 / iEM3275 |
| | Reactive energy | MID compliance, Class 2 conforming to BS/ EN/ IEC 62053-23 and BS/ EN/ IEC 61557-12 (PMD Sx): $I_{max}=6$ A, $I_n=5$ A, and $I_{st}=0.015$ A | iEM3235 / iEM3255 / iEM3265 / iEM3275 |

| Type of Measurement | Value | Meters |
|---------------------|---------------|---------|
| NMI | NMI 14/2/88 | iEM3255 |
| | -25 to 55 deg | |
| | NMI 14/2/89 | iEM3350 |
| | -25 to 60 deg | |

MID/MIR

| Characteristic | Value | Meters |
|-------------------------------------|-------|---|
| Electromagnetic environmental class | E2 | iEM3110 / iEM3115 / iEM3135 / iEM3155 / iEM3165 / iEM3175 / iEM3210 / iEM3215 / iEM3235 / iEM3255 / iEM3265 / iEM3275 / iEM3310 / iEM3335 / iEM3355 / iEM3365 / iEM3375 |
| Mechanical environmental class | M1 | |

For MID/MIR compliance, the **Wiring > Type** setting must be set to **3PH4W** or **1PH4W** (Total energy).

The meter complies with the MID 2014/32/EU or MIR SI 2016 No 1153 when installed in cabinets rated for IP51 or better in accordance with the instructions in DOCA0038EN, available on our website. The CE and UKCA declaration documents are available from the website. Search ECDiEM3000 for CE declaration document and UKMIRiEM3000 for UKCA declaration document.

Internal clock

| Characteristic | Value | Meters |
|----------------|---|---|
| Type | Quartz crystal based Backup by super capacitor | iEM3115 / iEM3135 / iEM3155 / iEM3165 / iEM3175 / iEM3215 / iEM3235 / iEM3255 / iEM3265 / iEM3275 / iEM3335 / iEM3355 / iEM3365 / iEM3375 |
| Time error | < 2.5 s/day (30 ppm) at 25 °C (77 °F) | |
| Backup time | 3 days at 25 °C (77 °F) | |

Modbus communications

| Characteristic | Value | Meters |
|-----------------|-------|---|
| Number of ports | 1 | iEM3150 / iEM3155 / iEM3250 / iEM3255 / iEM3350 / iEM3355 |

| Characteristic | Value | Meters |
|-------------------|--|--------|
| Labels | 0V, D0/-, D1/+, \ominus (shield) | |
| Parity | Even, Odd, None | |
| Baud rate | 9600, 19200, 38400 | |
| Isolation | 4.0 kV rms | |
| Wire | 2.5 mm ² / 14 AWG shielded twisted pair | |
| Wire strip length | 7 mm / 0.28 in | |
| Torque | 0.5 Nm / 4.4 in·lb | |

LonWorks communications

| Characteristic | Value | Meters |
|-------------------|--|-----------------------------|
| Number of ports | 1 | iEM3175 / iEM3275 / iEM3375 |
| Isolation | 3.75 kV rms | |
| Wire | 2.5 mm ² / 14 AWG shielded twisted pair | |
| Wire strip length | 7 mm / 0.28 in | |
| Torque | 0.5 Nm / 4.4 in·lb | |

M-Bus communications

| Characteristic | Value | Meters |
|-------------------|--|-----------------------------|
| Number of ports | 1 | iEM3135 / iEM3235 / iEM3335 |
| Parity | Even, Odd, None | |
| Baud rate | 300, 600, 1200, 2400, 4800, 9600 | |
| Isolation | 3.75 kV rms | |
| Wire | 2.5 mm ² / 14 AWG shielded twisted pair | |
| Wire strip length | 7 mm / 0.28 in | |
| Torque | 0.5 Nm / 4.4 in·lb | |

BACnet communications

| Characteristic | Value | Meters |
|-------------------|--|-----------------------------|
| Number of ports | 1 | iEM3165 / iEM3265 / iEM3365 |
| Labels | 0V, D0/-, D1/+, \ominus (shield) | |
| Baud rate | 9600, 19200, 38400, 57600, 76800 | |
| Isolation | 4.0 kV rms | |
| Wire | 2.5 mm ² / 14 AWG shielded twisted pair | |
| Wire strip length | 7 mm / 0.28 in | |
| Torque | 0.5 Nm / 4.4 in·lb | |

China Standard Compliance

This product complies with the following standard(s) in China:

iEM3100 series

BS/ EN/ IEC 62053-21 Electricity metering equipment (a.c.) - Particular requirements - Part 21: Static meters for active energy (classes 1 and 2)

BS/ EN/ IEC 61557-12 Electrical safety in low voltage distribution systems up to 1 000 V a.c. and 1 500 V d.c. - Equipment for testing, measuring or monitoring of protective measures - Part 12: Performance measuring and monitoring devices

GB/T 17215.211-2006 交流电测量设备-通用要求、试验和试验条件 第11部分：测量设备

GB/T 17215.321-2008 交流电测量设备 特殊要求 第21部分：静止式有功电能表(1级和2级)

iEM3200 series

BS/ EN/ IEC 62053-22 Electricity metering equipment (a.c.) - Particular Requirements - Part 22: Static meters for active energy (classes 0,2 S and 0,5 S)

BS/ EN/ IEC 61557-12 Electrical safety in low voltage distribution systems up to 1 000 V a.c. and 1 500 V d.c. - Equipment for testing, measuring or monitoring of protective measures - Part 12: Performance measuring and monitoring devices

GB/T 17215.211-2006 交流电测量设备-通用要求、试验和试验条件 第11部分：测量设备

GB/T 17215.322-2008 交流电测量设备 特殊要求 第22部分：静止式有功电能表 (0.2S级和0.5S级)

iEM3300 series

BS/ EN/ IEC 62053-21 Electricity metering equipment (a.c.) - Particular requirements - Part 21: Static meters for active energy (classes 1 and 2)

BS/ EN/ IEC 61557-12 Electrical safety in low voltage distribution systems up to 1 000 V a.c. and 1 500 V d.c. - Equipment for testing, measuring or monitoring of protective measures - Part 12: Performance measuring and monitoring devices

Schneider Electric
35 rue Joseph Monier
92500 Rueil Malmaison
France

+ 33 (0) 1 41 29 70 00

www.se.com

As standards, specifications, and design change from time to time,
please ask for confirmation of the information given in this publication.

© 2023 Schneider Electric. All rights reserved.

DOCA0005EN-14