

FEATURES

- Ultra-wide DIN rail mount DC-DC
 - 9...36Vdc
 - 18...75Vdc
- Efficiency up to 88%
- I/O isolation test voltage 1.5k VDC
- Industry standard pin-out
- Inhibit
- Operating temperature range - 40°C to +85°C
- Input under-voltage protection, output short circuit, over-current, over-voltage protection.
- EMI performance meets CISPR32 / EN55032 Class A without extra components
- EN62368 Approved

RS PRO 10W PCB mount wide Input DC-DC

2351357, 2351360, 2351362, 2351365, 2351369, 2351374, 2351378, 2351382, 2351384, 2351387, 2351391

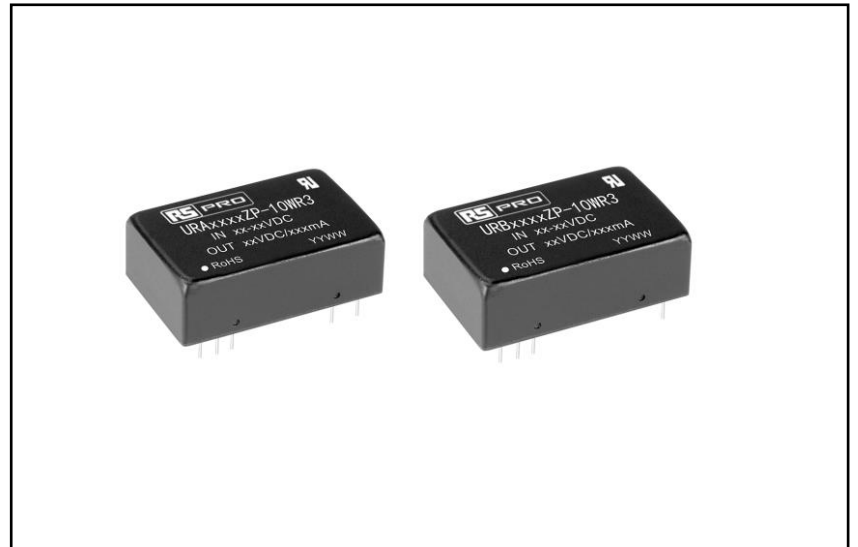

RS Professionally Approved Products bring to you professional quality parts across all product categories. Our product range has been tested by engineers and provides a comparable quality to the leading brands without paying a premium price.

Product Description

Embedded Switch Mode Power Supplies (SMPS)

PCB mount DC-DC converters feature an ultra-wide 4:1 input voltage with efficiencies of up to 88%, 1500VDC input to output isolation, an operating ambient temperature range of -40°C to +85°C, input undervoltage protection, output overvoltage, overcurrent, short circuit protection, CISPR32/EN55032 CLASS A EMI compliant without external components, which makes them widely used in industrial control, instrumentation and communications applications.

General Specifications

Model	DC-DC 10W Industrial PCB power supply
Mounting Type	PCB mount
MTBF	MIL-HDBK-217F@25°C > 1,000,000 hrs
Applications	Industrial control systems, instrumentation and equipment

RS Stock#	Input Voltage (Vdc)		Output Voltage	Output Current	Max. Capacitive Load(μF)	Efficiency (Typ)		
	Input Voltage	Max						
2351369	9 to 36Vdc	40	3.3V	2.4A	1200	87%		
2351374			5V	2A	1000	88%		
2351378			12V	0.833A	470	87%		
2351382			15V	0.667A	330	87%		
2351384			24V	0.416A	100	88%		
2351357			±5V	±1A	1000	83%		
2351360			±12V	±0.416A	470	87%		
2351362			±15V	±0.333A	330	87%		
2351387			18 to 75Vdc	80	5V	2A	1000	87%
2351391					12V	0.833A	470	87%
2351365	±12V	±0.416A			470	87%		

Input Specifications

Embedded Switch Mode Power Supplies (SMPS)

Input Specification						
Item	Operating Conditions	Min.	Typ.	Max.	Unit	
Input Current (full load / no-load)	24VDC nominal input series, nominal input voltage	3.3V output	-	379/12	388/25	mA
		5V output	-	473/6	484/15	
		others	-	502/5	515/12	
	48VDC nominal input series, nominal input	3.3V output	-	192/5	197/20	
		5V output	-	239/6	245/15	
		others	-	251/4	258/8	
Reflected Ripple Current	24VDC nominal input voltage	-	40	-		
	48VDC nominal input voltage	-	30	-		
Surge Voltage (1sec. max.)	24VDC nominal input series	-0.7	-	50	VDC	
	48VDC nominal input series	-0.7	-	100		
Start-up Voltage	24VDC nominal input series	-	-	9		
	48VDC nominal input series	-	-	18		
Input under-voltage protection	24VDC nominal input series	5.5	6.5	-		
	48VDC nominal input series	12	15.5	-		
Input Filter		Pi filter				
Hot Plug		Unavailable				
Ctrl*	Module on	Ctrl pin open or pulled high (TTL 3.5-12VDC)				
	Module off	Ctrl pin pulled low to GND (0-1.2VDC)				
	Input current when off	-	6	10	mA	
Note: *The Ctrl pin voltage is referenced to input GND						

Output Specifications

Embedded Switch Mode Power Supplies (SMPS)

Output Specification						
Item	Operating Conditions		Min	Typ.	Max	Unit
Voltage Accuracy	0%-100% load	3.3VDC/5VDC single output	-	±0.5	±2	
		Others		±1	±3	
Linear Regulation	Input voltage variation from low to high at full load	Vo1	-	±0.2	±0.5	%
		Vo2		±0.5	±1	
Load Regulation	5%-100% load	Vo1	-	±0.5	±1	
		Vo2		±0.5	±1.5	
Transient Recovery Time	25% load step change, nominal input voltage		-	300	500	µs
Transient Response Deviation		3.3VDC/5VDC single output	-	±5	±8	%
	Others	-	±3	±5		
Temperature Coefficient	Full load		-	-	±0.03	%/°C
Ripple & Noise *	20MHz bandwidth, 100% load		-	40	80	mV p-p
Over-voltage Protection	Input voltage range		110	-	160	%Vo
Over-current Protection	Input voltage range	3.3VDC/5VDC single output	110	160	230	%Io
		Others	110	140	190	
Short circuit Protection	Input voltage range		Continuous, self-recovery			
Note: ① At 0% - 5% load, the Max. output voltage accuracy of ±5VDC output converter is ±5%, the Max. output voltage accuracy of 3.3VDC/5VDC output converter is ±3%, ② Load regulation for 0% - 100% load increases to ±5%, ③ Ripple & Noise at						

Derating

Embedded Switch Mode Power Supplies (SMPS)

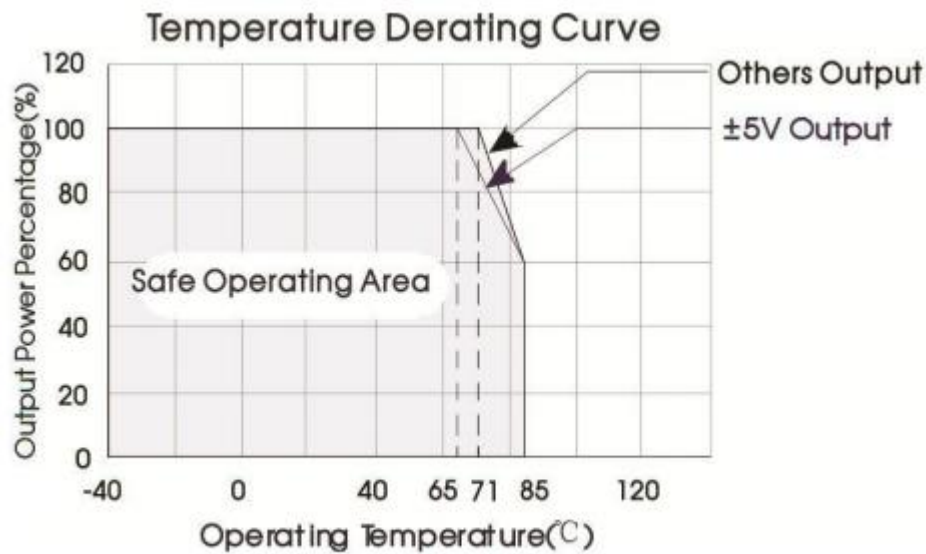

Fig. 1

General Specifications

Item	Operating Conditions	Min	Typ	Max.	Unit
Isolation	Input-output Electric Strength Test for 1 minute with a leakage current	1500	-	-	VDC
Insulation Resistance	Input-output resistance at 500VDC	1000	-	-	MΩ
Isolation Capacitance	Input-output capacitance at 100kHz/0.1V		2000		pF
Operating Temperature	See Fig. 1	-40	-	+85	°C
Storage Temperature		-55	-	+125	
Storage Humidity	Non-condensing	5	-	95	%RH
MTBF	MIL-HDBK-217F@25°C	1000			K hours
Pin Soldering Resistance Temperature	Soldering spot is 1.5mm away from case for 10 seconds	-	-	+300	°C
Vibration(EN62368)		10-150Hz, 5G, 0.75mm. along X,			
Vibration(EN50155)		IEC/EN61373 - Category 1, Grade B			
Switching Frequency *	PWM mode	-	PWM mode	-	KHz

Note:* Switching frequency is measured at full load. The module reduces the switching frequency for light load (below 50%) efficiency improvement.

EMC Specifications

Embedded Switch Mode Power Supplies (SMPS)

Electromagnetic Compatibility (EMC)		
Emissions	CE	CISPR32/EN55032 CLASS A (without extra components)/ CLASS B (see Fig.3-② for recommended circuit)
	RE	CISPR32/EN55032 CLASS A (without extra components)/ CLASS B (see Fig.3-② for recommended circuit)
Immunity	ESD	IEC/EN61000-4-2 Contact ± 4 KV perf. Criteria B
	RS	IEC/EN61000-4-3 10V/m perf. Criteria A
	EFT	IEC/EN61000-4-4 ± 2 KV (see Fig.3-① for recommended circuit) perf. Criteria B
	Surge	IEC/EN61000-4-5 line to line ± 2 KV (see Fig.3-① for recommended circuit) perf. Criteria B
	CS	IEC/EN61000-4-6 10 Vr.m.s perf. Criteria A
	Immunities of voltage dip, drop and short interruption	IEC/EN61000-4-29 0%, 70% perf. Criteria B

Electromagnetic Compatibility (EMC) (EN50155)		
Emissions	CE	EN50121-3-2 150kHz-500kHz 99dBuV(see Fig.3-② for recommended circuit) EN55016-2-1 500kHz-30MHz 93dBuV(see Fig.3-② for recommended circuit)
	RE	EN50121-3-2 30MHz-230MHz 40dBuV/m at 10m(see Fig.3-② for recommended circuit) EN55016-2-1 230MHz-1GHz 47dBuV/m at 10m(see Fig.3-② for recommended circuit)
Immunity	ESD	EN50121-3-2 Contact ± 6 KV/Air ± 8 KV perf. Criteria B
	RS	EN50121-3-2 20V/m perf. Criteria A
	EFT	EN50121-3-2 ± 2 kV 5/50ns 5kHz(see Fig.3-① for recommended circuit) perf. Criteria A
	Surge	EN50121-3-2 line to line ± 1 KV (42 Ω , 0.5 μ F) (see Fig.3-① for recommended circuit) perf. Criteria A
	CS	EN50121-3-2 0.15MHz-80MHz 10 Vr.m.s perf. Criteria A

1. Typical Application

Embedded Switch Mode Power Supplies (SMPS)

All DC-DC converters of this series are tested before delivery using the recommended circuit shown in Fig. 2. Input and/or output ripple can be further reduced by appropriately increasing the input & output capacitor values C_{in} and C_{out} and/or by selecting capacitors with a low ESR (equivalent series resistance). Also make sure that the capacitance is not exceeding the max. capacitive load value of the product.

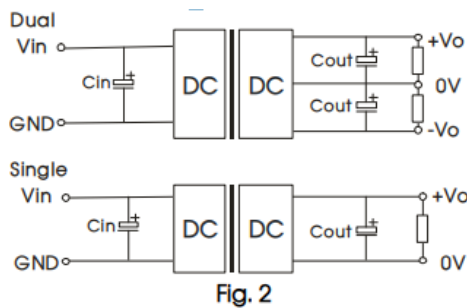

$V_{in}(VDC)$	C_{in}	C_{out}
24	100 μ F	10 μ F
48	10 μ F - 47 μ F	10 μ F

EMC compliance circuit

3.3VDC/5VDC single output:

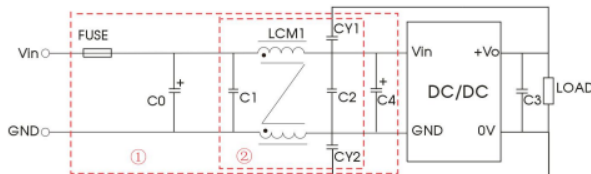

Others:

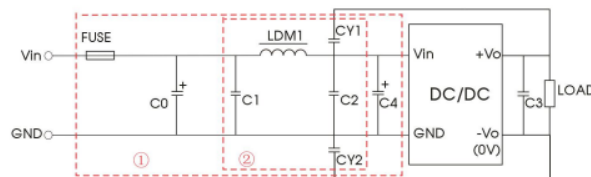

Fig. 3

Note: Notes: For EMC tests we use Part ① in Fig. 3 for Immunity and part ② for emissions test, chose according to the demand.

- The products do not support parallel connection of their output
- For additional information please refer to DC-DC converter application notes on

Parameter description:

Model	$V_{in}:24V$	$V_{in}:48V$
FUSE	Select FUSE value according to actual input current	
C0, C4	330 μ F/50V	330 μ F/100V
C1, C2	10 μ F/50V	10 μ F/100V
LDM1	10 μ H	
LCM1	1.4-1.7mH (TN150P-RH12.7*12.7*7.9)	
C3	Refer to the C_{out} in Fig.2	
CY1, CY2	1nF/2KV	

Mechanical Specifications

Case material	Aluminium alloy
Dimensions	32.00 x 20.00 x 10.80mm
Weight	12g (Typ.)
Cooling Method	Free air convection

Dimensions and recommended layout

Embedded Switch Mode Power Supplies (SMPS)

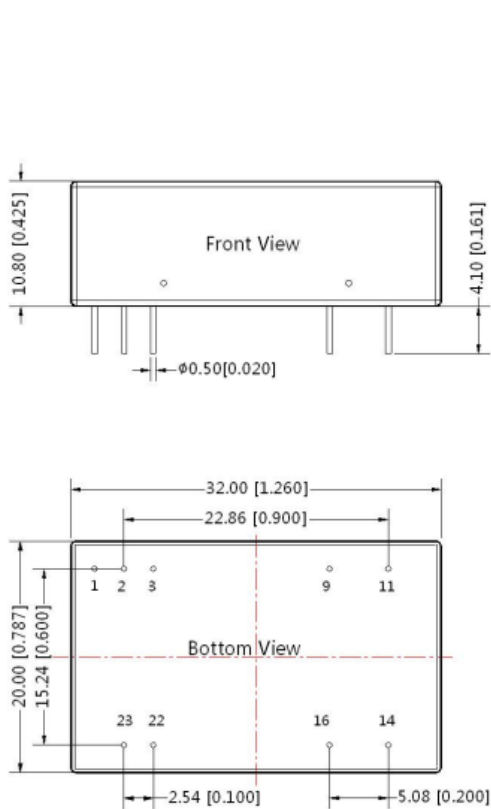

Note:
 Unit :mm[inch]
 Pin diameter tolerances :±0.10[±0.004]
 General tolerances:±0.50[±0.020]

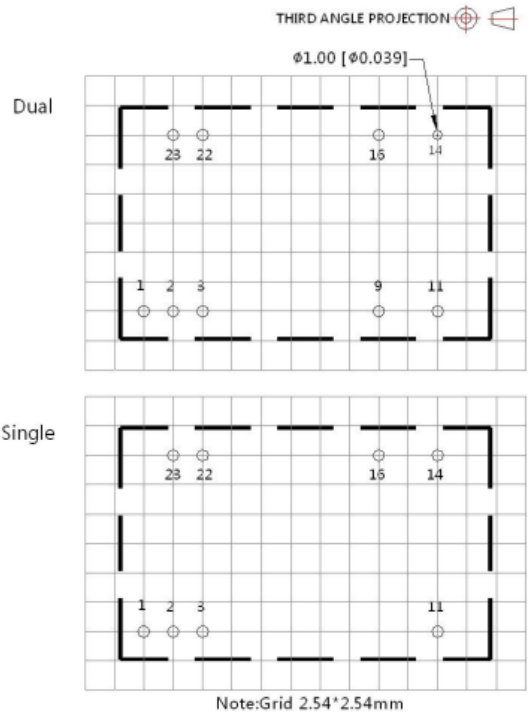

Pin-Out		
Pin	Single	Dual
1	Ctrl	Ctrl
2,3	GND	GND
9	No Pin	0V
11	NC	-Vo
14	+Vo	+Vo
16	0V	0V
22,23	Vin	Vin

NC: Pin to be isolated from circuit

Approvals

Safety	EN62368
---------------	---------

1. If the product is not operated within the required load range, the product performance cannot be guaranteed to comply with all parameters in the datasheet.
2. The maximum capacitive load offered were tested at input voltage range and full load.
3. Unless otherwise specified, parameters in this datasheet were measured under the conditions of Ta=25°C, humidity