

Plug - Part no. 629A

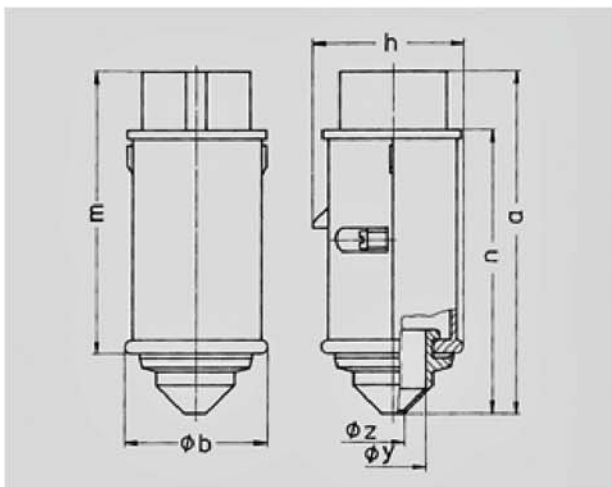

- screw terminals
- with grommet

Protection type IP 44
 Ampere 16A
 Poles 2p
 Voltage low voltage
 Hertz 50-60Hz
 Earth position 0h
 Contact standard
 Connection technology Screw terminals

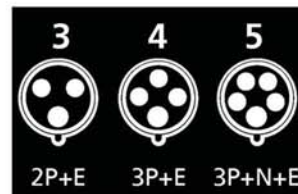

Drawing	Amp.	16		32	
		2	3	2	3
2 MB 159	Poles				
Dim. in mm	a	130	130	130	130
	b	55	55	55	55
	h	58	58	58	58
	m	108	108	108	108
	n	107	107	107	107
	y	25	25	25	25
	z	9	9	9	9
Terminal for cond. cross		4	4	4	4
section (mm ²) min.-max.		-10	-10	-10	-10

