

## Datasheet

### SPDT Toggle Switch On-On, 3 A, Panel Mount

RS Stock number [734-7227](#)

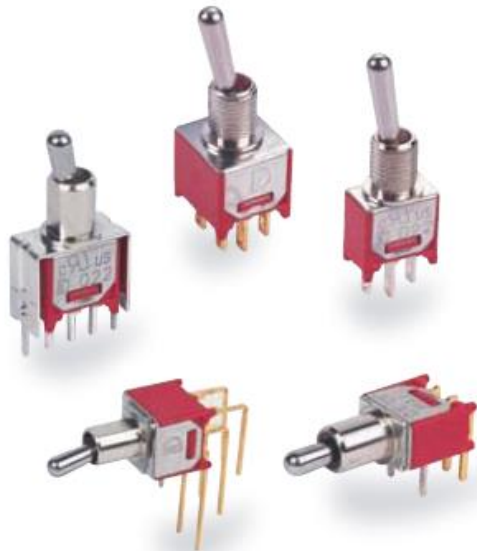

#### SPECIFICATIONS

**CONTACT RATING:** Dependent upon contact material

**MECHANICAL LIFE:** 30,000 make-and-break cycles.

**CONTACT RESISTANCE:** 20 m $\Omega$  max. initial @ 2-4VDC

100mA for both silver and gold plated contacts.

**INSULATION RESISTANCE:** 1,000 M $\Omega$  min.

**DIELECTRIC STRENGTH:** 1,000 Vrms min.@sea level.

**OPERATING TEMPERATURE:** -30°C to 85°C.

#### MATERIALS

**CASE:** Diallyl phthalate (DAP) (UL94v-0).

**ACTUATOR:** Brass, chrome plated.

**BUSHING:** Brass or zinc, nickel plated.

**HOUSING:** Stainless Steel.

**SWITCH SUPPORT:** Brass,tin plated.

**TERMINAL/CONTACT:** Brass,with Silver or gold plated.

**SWITCH FUNCTION**

NO. POLES	UL/CSA MODEL NO.	MODEL NO.	SWITCH FUNCTION			CONNECTED TERMINALS / SCHEMATIC		
			POS.1	POS.2	POS.3	POS.1	POS.2	POS.3
SP	Q2211	2MS1	ON	NONE	ON	2-3	N/A	2-1
	Q2212	2MS2	ON	NONE	MOM			
	Q2213	2MS3	ON	OFF	ON		OPEN	
	Q2214	2MS4	MOM	OFF	MOM			
	Q2215	2MS5	ON	OFF	MOM	OPEN	N/A	3-1
	Q2216	2MS6	OFF	NONE	ON			
DP	Q2221	2MD1	ON	NONE	ON	2-3,5-6	N/A	2-1,5-4
	Q2222	2MD2	ON	NONE	MOM			
	Q2223	2MD3	ON	OFF	ON		OPEN	
	▲ Q2226	2MD6	ON	ON	ON			

MOM=MOMENTARY

▲ Please check the availability in advance before order

**POLE OPTIONS**

**SPDT**

Part No. Shown : 2MS1T1B1M1QE

2MS6 Models : Omit 2nd terminal

**DPDT**

Part No. Shown : 2MD1T1B1M1RE

**ACTUATOR OPTIONS**

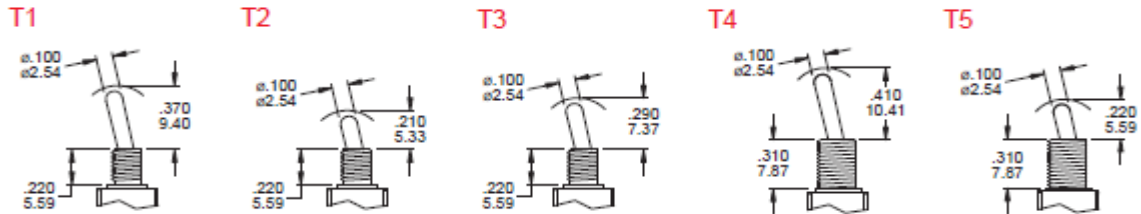

NONE: T1,T2,T3 Actuator shown with B1 to B4 bushing, subtract 0.09 ( 2.29 ) for B5 bushing, subtract 0.04 ( 1.02 ) for B7 bushing.  
 T4,T5 Actuator shown with B5,B6 bushing, add 0.09 ( 2.29 ) for B1 to B3 bushing, add 0.05 ( 1.27 ) for B7 bushing.  
 Std for M1,M2 Terminal sub .016(.040) for M6,M7,VSX

**TL1B25**

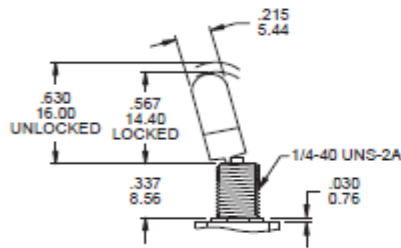

**TL2B25**

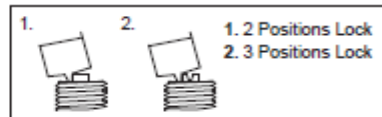
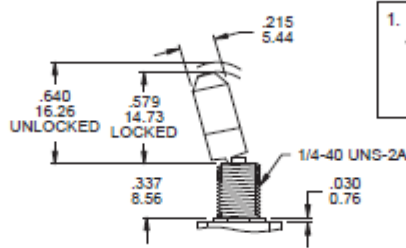

**BUSHING OPTIONS**

**B1 THD  
B2 NON-THD**

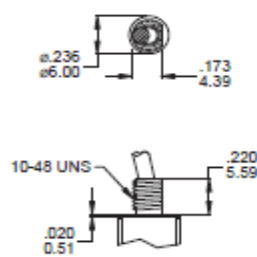

**B3 THD  
B4 NON-THD**

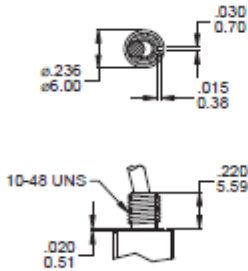

**B5 THD  
B6 NON-THD**

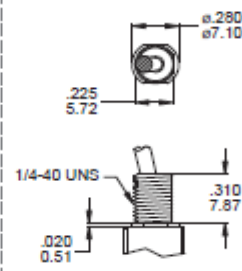

**B7 THD  
B8 NON-THD**

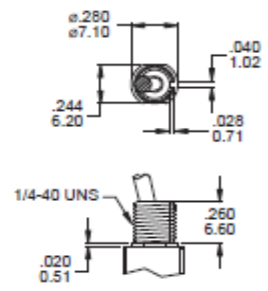

**TERMINATION OPTIONS**

**M1 Solder lug**

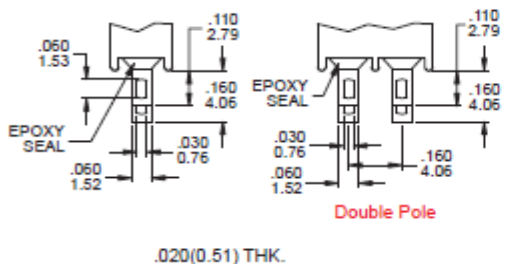

**M2 PC Thru-hole**

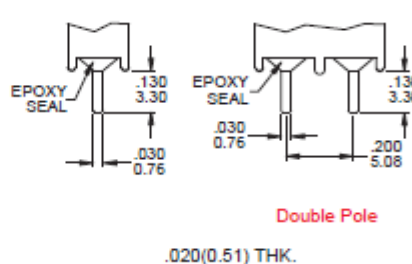

**M5 Wire Wrap**

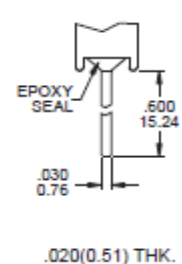

M6

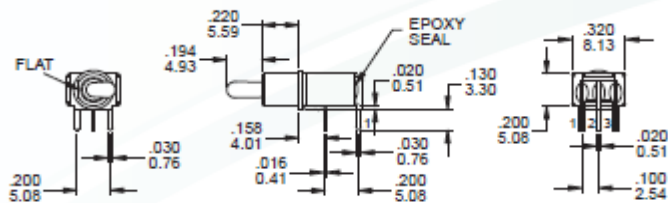

P.C. MOUNTING

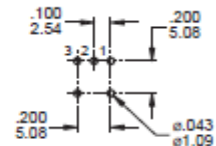

SPDT

Part No. Shown : 2MS1T2B2M6RE

M6

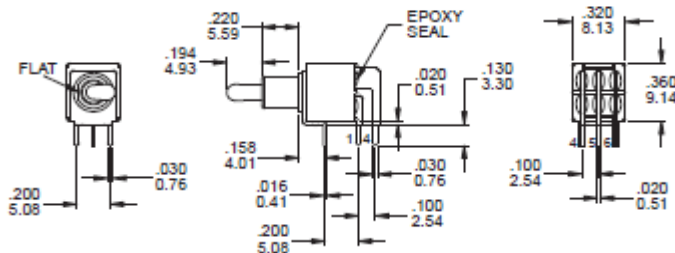

P.C. MOUNTING

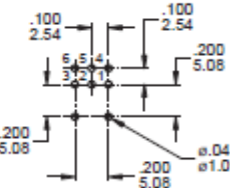

DPDT

Part No. Shown : 2MD1T2B2M6QE

M7

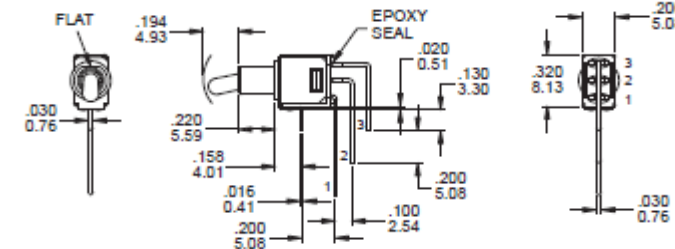

P.C. MOUNTING

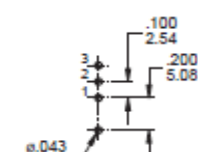

SPDT

Part No. Shown : 2MS1T2B2M7RE

M7

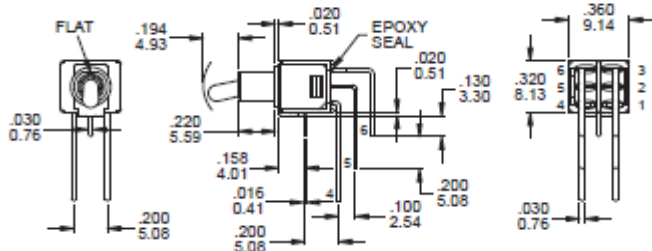

P.C. MOUNTING

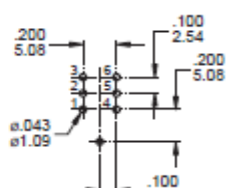

DPDT

Part No. Shown : 2MD1T2B2M7RE

VS2 - VS3



SPDT

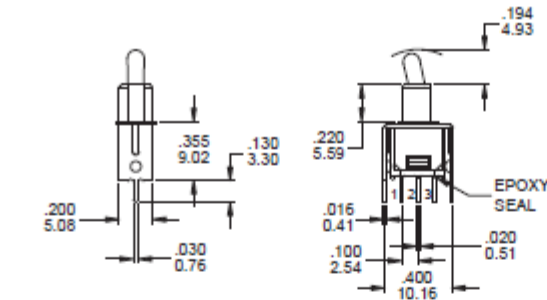

Part No. Shown : 2MS1T2B2VS2QE

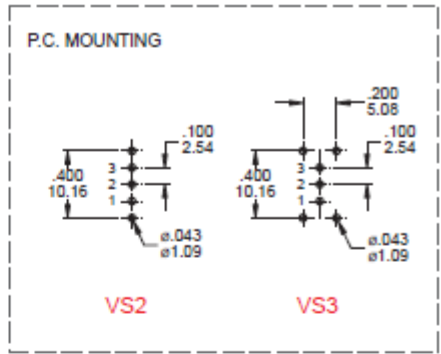

VS2 - VS3



DPDT

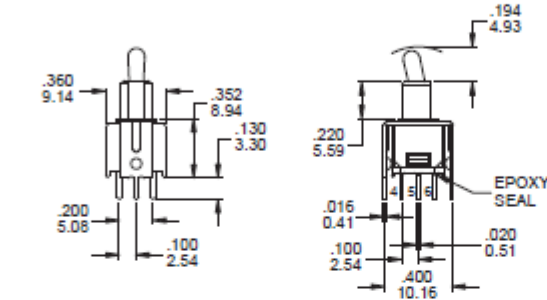

Part No. Shown : 2MD1T2B2VS2QE

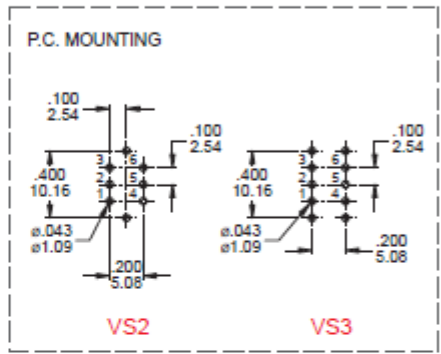

**SNAP-IN TERMINATION OPTIONS**

M6N



M7N

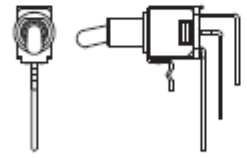

V2N

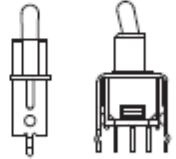

V3N

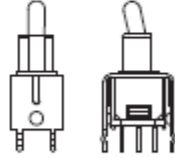

**PANEL MOUNTING**

10-48 BUSHING

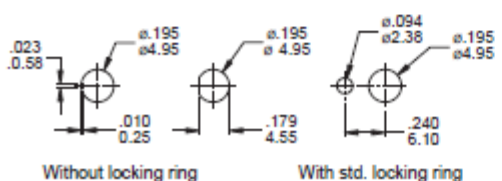

Without locking ring

With std. locking ring

1/4 IN. BUSHING

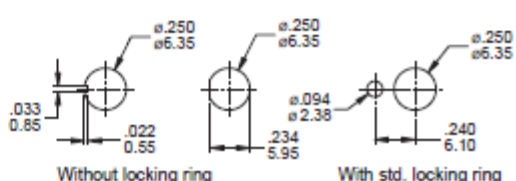

Without locking ring

With std. locking ring

**HARDWARE**

**10-48 NUT**

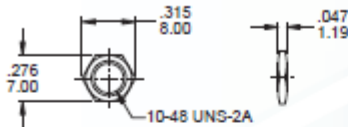

**MNU-2M01**

Supplied standard with B1/ B3 bushing

**LOCK WASHER**



**MNU-2M03**

Supplied standard with B1 / B3 bushing

**CONTACT MATERIAL OPTIONS**

	CONTACT PLATING	TERMINAL PLATING	RATINGS
Q	Silver	Q = Silver	3 Amps with resistant load @ 120VAC or 28VDC 1 Amps with resistant load @ 250VAC
S		S = Silver,pure - tin	
C	Gold over Silver	C = Gold over silver	
K		K = Gold over silver,pure - tin	
R	Gold	R = Gold	0.4 Volt - Amps ( VA ) max. @ 20V max. ( AC or DC )
G		G = Gold,pure - tin	

**SOLDERING PROCESSES**

**MANUAL SOLDERING:** Use soldering iron of 30 watts, controlled at 350°C approximately 5 seconds while applying solder.

**WAVE SOLDERING:** Recommended Soldering Temperature: 260 ± 5°C

Duration of Solder Immersion: Max 5 sec. (PCB is 1.6mm in thickness)