

# Datasheet

## Pan Head Machine Screw

RS Stock number: 528-772

Dimensions(mm):

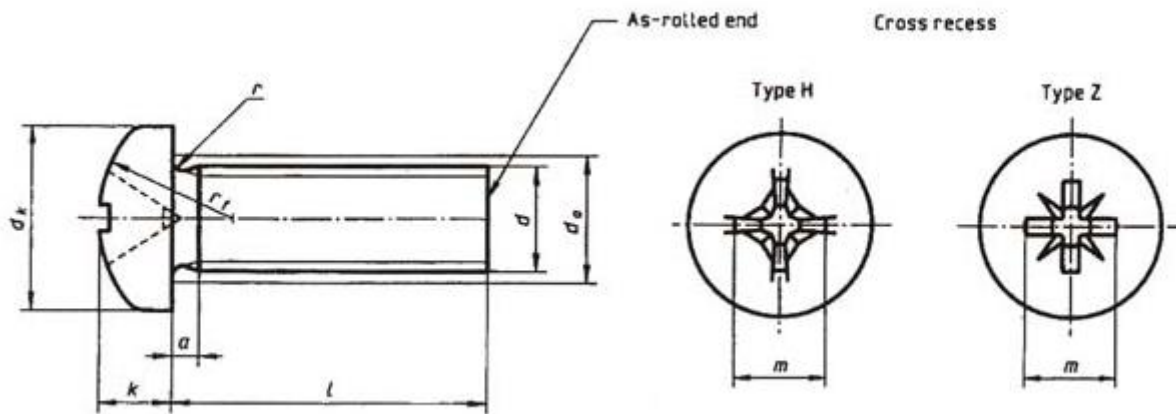

Size	M2	M3	M4	M5	M6	M8
$m \approx$	2.5	3.1	4.6	5.3	6.8	9
<b>R1</b>	4	6	8	10	12	16
<b>a max.</b>	-	1	1.4	1.6	2	2.5
$v \approx$	1.1	1.6	2	2.5	3	3.7
<b>k</b>	1.6	2.4	3.1	3.8	4.6	6
<b>d1 max.</b>	4	6	8	10	12	16