



ENGLISH

Datasheet

RS Pro Centre Drills

BS Style: BS 328 / DIN 333A / ISO 866

RS Stock No: 408-7944

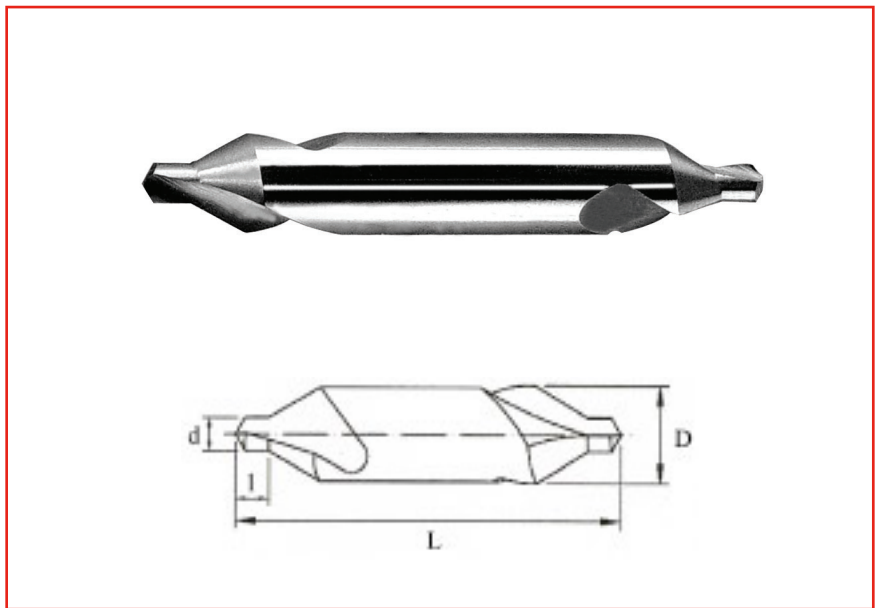

Specifications:

Produces conical centre holes in components which require machining between centres or a centre support to provide rigidity

Countersink angle: 60°

Point geometry: 120°

Right hand cutting

Silver finish

Supplied in plastic pack

RS Code	Manufacturers Code	Size	d (inch)	D (inch)	i (inch)	L (inch)
408-7944	22-100-004	BS4	1/8	5/16	3/16	2-1/4