

Datasheet

PCB Mount Type C Female + Locking Spring

RS Stock number 895-0552

Unit: mm

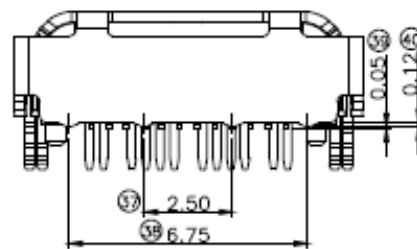
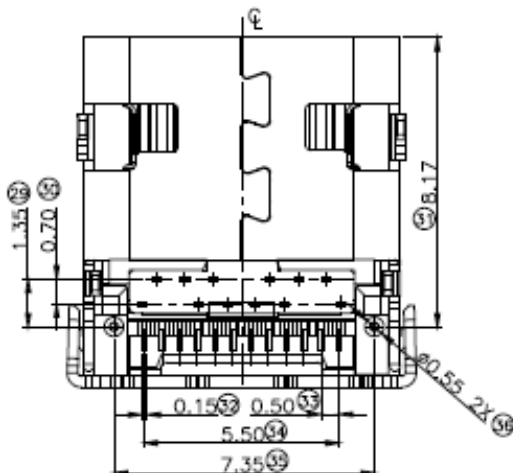
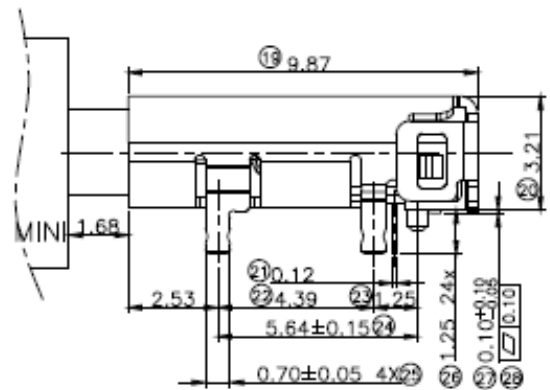
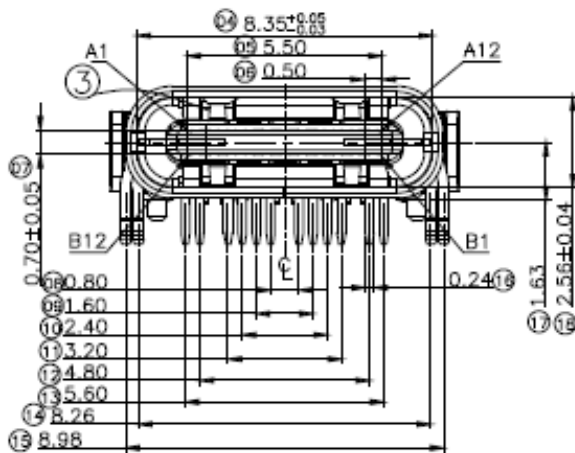
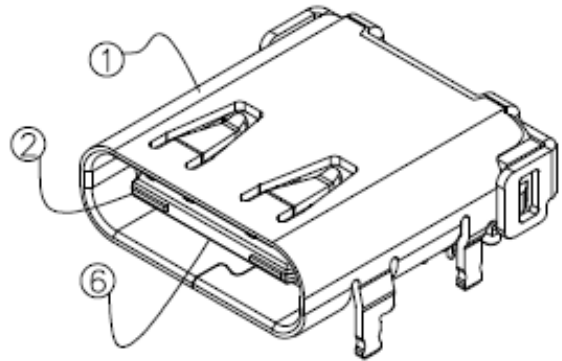
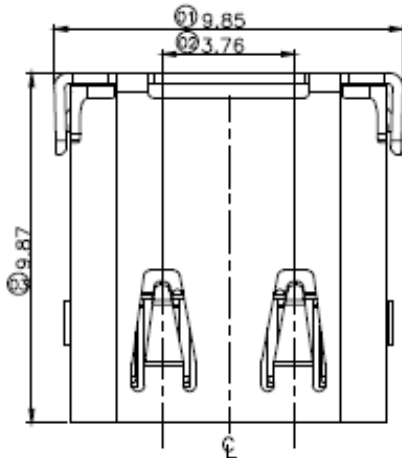



ENGLISH

1. SERIES NO.
3K: USB TYPE C CONNECTOR
2. TAIL CONSTRUCTION TYPE
G: SMT+H/T TYPE
3. NUMBER OF PIN
024: 24 POSITIONS
4. CONTACT & CONNECTING TYPES:
S: SOCKET
5. HOUSING COLOR.
3: BLACK
6. TERMINAL PLATING:
0S: CONTACT AREA: Au 1U", SOLDER AREA:GOLD FLASH
05: CONTACT AREA: Au 15U", SOLDER AREA:GOLD FLASH
06: CONTACT AREA: Au 30U", SOLDER AREA:GOLD FLASH
7. SHELL PLATING
N: PLATING NI
8. ENVIRONMENTAL.
3: HF
9. PACKING.
R: TAPE REEL PACKING
10. AUXILIARY CODE.
2: With a back cover and LOGO
11. SUFFIX NO.
001:CENTER HEIGHT H=1.63mm