



ENGLISH

Product Datasheet

Din Rail mini Terminal Blocks, 4sq.mm



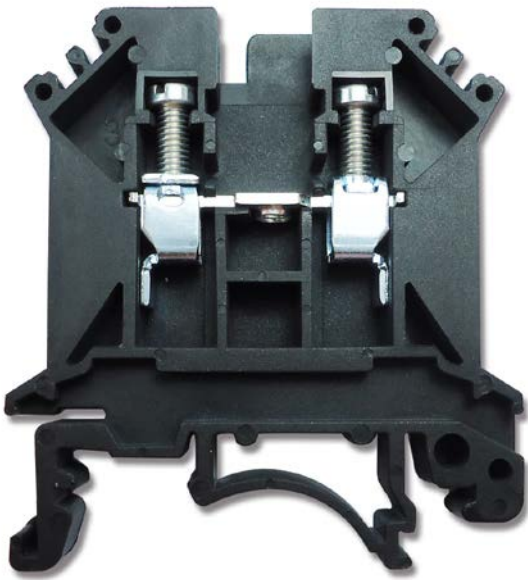

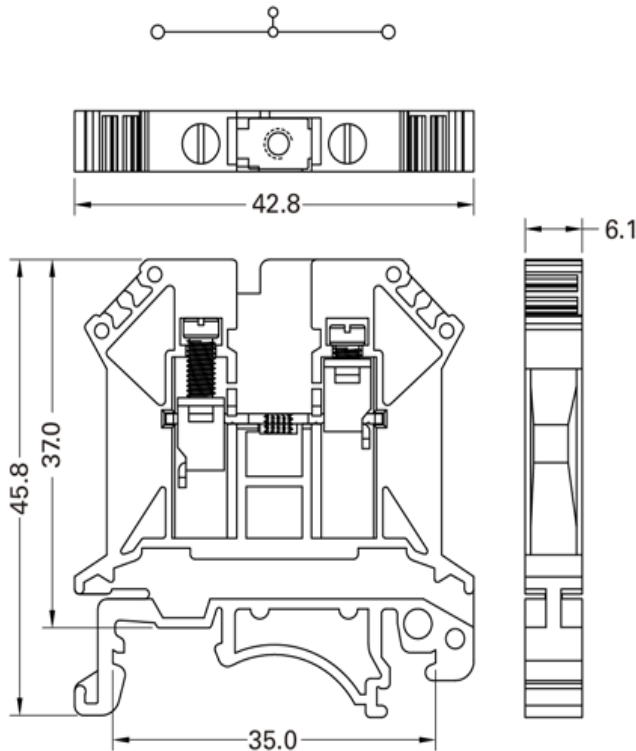

Screw Clamp mini Terminal Blocks, 30A, 600V, 22-10 AWG, 0.5-4 sq.mm, Black
878-7528



Dimensions in mm

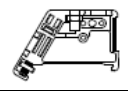

Product Specifications:

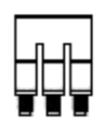
Specifications	4mm ²
Technical Date	Rated voltage / Rated current / Wire size
UL	600V / 30A / AWG 22-10
CSA	600V / 30A / AWG 22-10
IEC	800V / 32A / 0.5-4mm ²
Insulating impulse voltage withstand/pollution degree	8KV / 3
Torque (in -lbs)	10
Clamping Screw (M)	M3
Insulation stripping length (mm)	8~10 mm
Net weight per piece	7.2 g
Material / Available Color (Standard Color: Beige)	 Red Orange Beige Blue Grey White Black
Rail Dimensions	T / W / H (mm)
For TS35x7.5 	6.1 x 42.5 x 47
For TS35x15 	6.1 x 42.5 x 54.5
Accessories	Cat. No.
End Bracket 	8787553
	8787556
End plate 	8787544
Cross 	8787581