

Circuits from the Lab[®]
Reference Designs

Circuits from the Lab[®] reference designs are engineered and tested for quick and easy system integration to help solve today's analog, mixed-signal, and RF design challenges. For more information and/or support, visit www.analog.com/CN0549.

Devices Connected/Referenced

CN-0540	Single Channel, 24-Bit, IEPE Vibration Data Acquisition System
CN-0532	10 kHz, IEPE, MEMs Vibration Sensor
XLMOUNT1	20 kHz, MEMs, Accelerometer Mechanical Mounting Block for Vibration Analysis

IEPE-Compliant, CbM Machine Learning Enablement Platform

EVALUATION AND DESIGN SUPPORT

Circuit Evaluation Boards

- [CN-0540 Reference Design Board \(EVAL-CN0540-ARDZ\)](#)
- [CN-0532 Reference Design Board \(EVAL-CN0532-EBZ\)](#)
- [XLMOUNT1 Mechanical Mounting Block \(EVAL-XLMOUNT1\)](#)

Design and Integration Files

- [Schematics, Layout Files, Bill of Materials, Software, MATLAB Examples, Python Examples](#)

CIRCUIT FUNCTION AND BENEFITS

Machine condition-based monitoring (CbM) by means of vibration sensing is growing in importance in industrial applications. Companies are seeking to optimize machinery lifetime and performance and to reduce the cost of ownership, while some are looking to develop new business models around the provision of such information. To provide an accurate representation of machinery that needs monitoring, large datasets must be collected to determine a baseline operating point for the equipment in both normal operating modes and failure conditions. Once this data is collected, an algorithm or threshold detection routine can be created to provide the correct analysis for this equipment.

CbM requires capturing full bandwidth data to ensure that all harmonics, aliasing, and other mechanical interactions in both the time and frequency domain are accounted for. This data collection requires a high performance sensor and data acquisition (DAQ) system that can provide high fidelity, real-time data into a data analysis tool or application.

Using established tools like MATLAB[®] or newer Python-based tools like Tensorflow, analyzing the data, profiling the machinery, and creating algorithms for smart decision making is greatly simplified.

Vibration sensing has traditionally dominated most CbM applications because of the availability of sensors, and the science behind the analysis is better understood. The integrated electronic piezoelectric (IEPE) standard is a popular signaling interface standard for high end microelectronic mechanical systems (MEMS) and piezo sensors that are prevalent in the industry today.

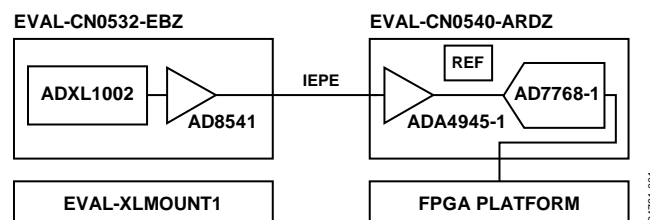

Figure 1. CN-0549 System Block Diagram

Rev. 0

Circuits from the Lab[®] reference designs from Analog Devices have been designed and built by Analog Devices engineers. Standard engineering practices have been employed in the design and construction of each circuit, and their function and performance have been tested and verified in a lab environment at room temperature. However, you are solely responsible for testing the circuit and determining its suitability and applicability for your use and application. Accordingly, in no event shall Analog Devices be liable for direct, indirect, special, incidental, consequential or punitive damages due to any cause whatsoever connected to the use of any Circuits from the Lab circuits. (Continued on last page)

CIRCUIT DESCRIPTION

Vibration Analysis

Vibration sensing has traditionally dominated most CbM applications because of the availability of sensors, and the science behind the analysis is better understood. However, what if a new piece of equipment needs analyzing, or a need to better understand how a particular use case affects equipment arises. To gain the necessary insights, first an understanding of how the machinery behaves when working in optimal conditions and in failure inducing conditions is required. Figure 2 provides an example of what a frequency spectrum might look like when operating with a vibration source.

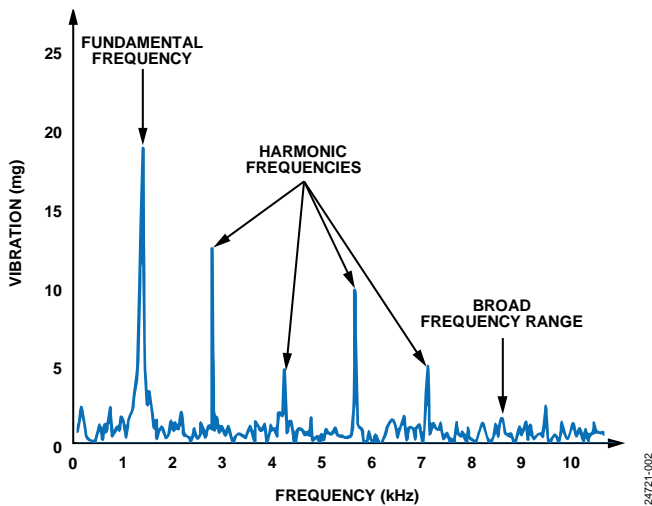

Figure 2. Example Frequency Spectrum of a Vibration Source

Vibration Sensors—IEPE Interface

IEPE is a popular interface standard for high end, piezo vibration sensors that are prevalent in the industry today. The IEPE interface is a 2-wire signaling standard that consists of a signal and ground only. A DAQ card, such as the [CN-0540](#), supplies power via the signal line to the [CN-0532](#) vibration sensor as current with an arbitrary voltage, typically between 10 V to 30 V. Because the signal line is supplied by a current source, the sensor device can modulate the acceleration data on the voltage rail. Therefore, a single wire can be used for both the power supply and the modulated output voltage of the sensor.

MEMS vs. Piezos

Piezo accelerometers dominate the CbM market today because of their wideband frequency response and sensitivity to vibration stimuli. However, with recent advancements with MEMS technology, the gap between piezos and MEMS accelerometer sensors are closer in performance than ever before.

The CN-0532 IEPE MEMS vibration sensor is based on the [ADXL1002](#). The noise and bandwidth is comparable with a piezoelectric sensor while the ADXL1002 provides superior performance in temperature sensitivity, dc to low frequency response, phase response (and thus, group delay), shock tolerance, and shock recovery. The sensor has a linear (within $\pm 0.1\%$ full-scale ratio (FSR)) measurement range of ± 50 g, which is large enough to support a wide array of vibration applications. For more information about the ADXL1002 and how it is used in an IEPE interface, visit the [CN-0532](#) web page.

When using the CN-0549, it is possible to directly compare piezo sensor performance with that of a MEMS-based sensor solution.

Mechanical Sensor Mounting

A major challenge for CbM applications is trying to bridge the analog and digital worlds. Getting dependable sensor data from the machine being monitored into the processor is challenging. First and most importantly, a connection between the sensor and the piece of equipment being monitored must be established. Once attached to the piece of machinery, it is important to ensure that the vibration spectrum is not altered by any mechanical anomalies or effects due to the mounting of the sensor.

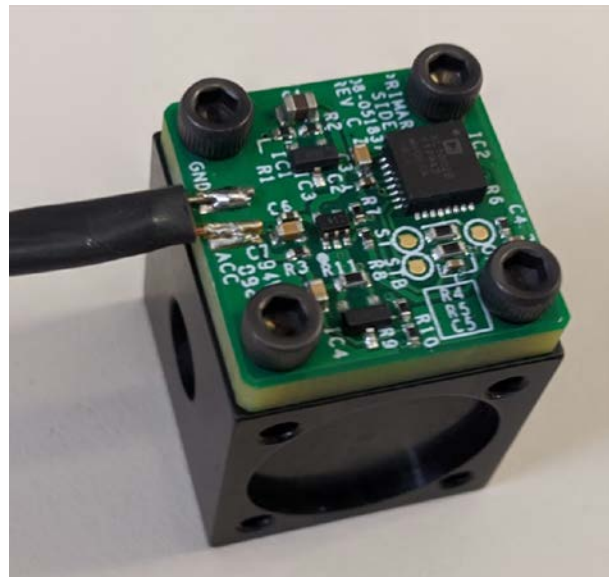

Figure 3. The [EVAL-XLMOUNT1](#) with the [EVAL-CN0532-EBZ](#)

The EVAL-XLMOUNT1 is a five sided mounting cube that allows a user to attach the CN-0532 to a piece of equipment without any sensor degradation to data. The EVAL-XLMOUNT1 was designed and tested to ensure that all error sources due to the mechanical attachment have been removed out to a frequency of 20 kHz. The mounting cube was also anodized to form a nonconductive layer on the aluminum surface to prevent short circuits.

Data Acquisition—IEPE

Typical data acquisition takes voltages and currents directly and converts them into digital codes. However, because the IEPE interface is different, a more specialized DAQ board is needed. The DAQ board must be able to power the sensor with the correct current and excitation voltage level, as well as be able to read back the data the sensor has gathered, which is modulated on that same excitation voltage.

The CN-0540 is a 24-bit, single channel DAQ system that is optimized to interface with IEPE sensors (see Figure 4). This DAQ system is capable of supplying a maximum excitation voltage of approximately 26 V to the sensor. The AD7768-1 ADC samples at 256 KSPS, which means that 6.144 Mbps of data is sent to the processor every second. For more detailed information regarding the data acquisition used, visit the CN-0540 web page.

Field Programmable Gate Array (FPGA) Host

Because the CN-0540 hardware is in a standard Arduino® form factor, any processing system that can support the necessary data rates, electrical pinout, and mechanical form factor of the Arduino form factor can support the CN-0540. Development systems from two major FPGA manufacturers, the Intel DE10-Nano system on chip (SoC) platform and the Xilinx Cora Z7-07S SoC platform, are supported with complete reference designs. The hardware device language (HDL) reference designs are provided as open source software. Therefore, these designs can

be easily ported to other platforms depending on preference. For more information about the HDL files and documentation, visit the CN0540 HDL user guide page.

FPGA-based SoCs were chosen specifically due to the large amount of high precision data that can be produced from the CN-0540. FPGAs can be used to offload fixed processing that can be efficiently performed in logic at much lower power compared to CPU processing, freeing up the embedded ARM® to do other tasks.

Software Architecture and Infrastructure

Both the DE10-Nano and Cora Z7-07Ss SoC platforms run Linux to interface and control the CN-0540. Linux is provided through the Analog Devices, Inc., Kuiper Linux distribution, which is based on Raspbian. This distribution includes standard software tools for embedded development and debugging, including standard compilers and even interpreters like Python. The kernel provided with this distribution includes the necessary drivers to control the different components of the CN-0540.

The drivers for the CN-0540 are provided in the standard kernel driver framework, which is called the Industrial Input Output (IIO) framework. The IIO framework supports products like converters, amplifiers, sensors, and several other components that Analog Devices, as well as many other vendors, manufacture.

For more information on the CN-0540 software files and how to prepare the software image for use, visit the Analog Devices Kuiper Linux web page.

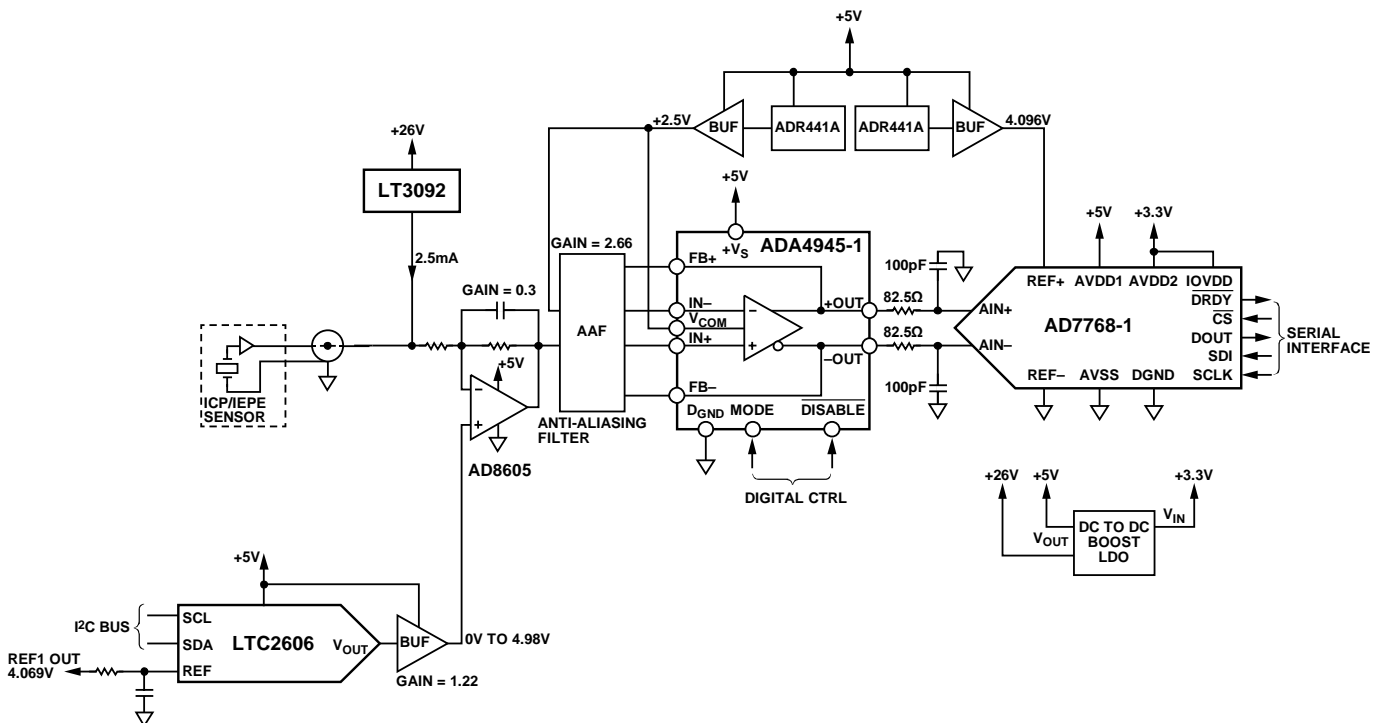

Figure 4. Simplified Block Diagram of CN-0540

Low Level Control

The IIO drivers handle both the control of the [CN-0540](#) as well as the data or buffer collection aspects. To interface with the driver at the lowest levels, including register access, the IIO library (libIIO) can be used. libIIO itself can communicate with the driver by run code directly on the SoC boards or remotely from a host PC. A standard graphical interface, IIO-Oscilloscope, is provided for debugging IIO devices. This tool comes standard with moving fast Fourier transforms (FFTs) that allow a user to visualize any vibration anomaly occurring within the sensors bandwidth, enabling basic debugging and analysis, even without connecting an external PC.

The IIO-Oscilloscope supports customizable plugins to simplify interaction with specific driver collections. The CN-0540 does have a specific plugin to help calibrate out the IEPE bias errors and maximize the amplifier gain of the circuit. This calibration can be done generically through the IIO-Oscilloscope, but the plugin makes the calibration process simpler for users.

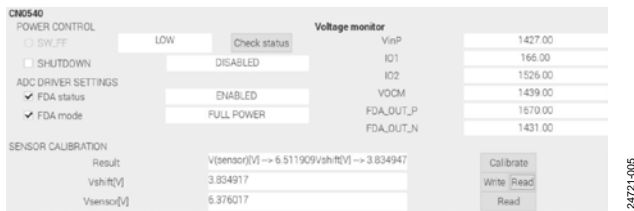

Figure 5. CN-0540 IIO-Oscilloscope Plugin Graphical User Interface

Algorithm Development—MATLAB and Python

Once verification and validation that the system is operating as intended with the IIO-Oscilloscope is completed, users can migrate to other interfaces in different languages and tools that are designed for data analysis. It is possible to interface with the CN-0540 from C/C++. However, the primary tool integrations are provided in Python and MATLAB, which allows simplified workflows to get data into frameworks like Tensorflow and PyTorch based in Python side, or different toolboxes for MATLAB.

Python support for the CN-0540 is provided through the [pyadi-iio](#) module. This module provides an easy to use application programming interface (API) that is geared toward data scientists and those developing algorithms. The module comes preinstalled with Kuiper Linux and is also available through the Python Package Index PyPI. Figure 6 is a simple example of connecting and pulling data from the CN-0540 with the ADXL1002 attached.

```
import adi # Import module
xl = adi.adxl1002("ip:192.168.2.1") # create object
xl.sample_rate = 1024 # Set sample rate
data = xl.rx() # Collect data
```

Figure 6. CN-0540 Python Example

MATLAB support for the CN-0540 is provided through the [Analog Devices Sensor Toolbox](#), which is a self-contained toolbox with examples, interface classes, and targeting infrastructure for sensor like hardware. The MATLAB interface classes like the Python classes follow a common API, which is based on historical APIs from MathWorks. Like Python, the interface classes provide a simple to use API that is geared toward data scientists and those doing algorithm development. Figure 7 is a simple example of connecting and pulling data from the CN-0540 with the ADXL1002 attached.

```
% Accel
xl = adi.ADXL1002; % Create object
xl.SampleRate = 1024; % Set sample rate
xl.uri = 'ip:192.168.2.1'; % set URI
acceldata = xl(); % Collect data
```

Figure 7. CN-0540 MATLAB Example

The toolbox is installable directly from MATLAB's Addon Explorer or through installers from GitHub.

COMMON VARIATIONS

Adding more sensors requires more DAQ channels to be available. For more input channels, the [AD7768-4](#) contains up to 4 channels, and the [AD7768](#) has up to 8 input channels available.

MEMs vibration sensors that require either a different bandwidth or G range are also available using the [ADXL1003](#), [ADXL1004](#), and [ADXL1005](#) MEMs accelerometers.

CIRCUIT EVALUATION AND TEST

Equipment Needed

The following equipment is needed:

- The [EVAL-CN0532-EBZ](#)
- The [EVAL-CN0540-ARDZ](#)
- The [EVAL-XLMOUNT1](#)
- The [DE10-Nano FPGA Development Board](#)
- A Subminiature A (SMA) cable
- A High-Definition Multimedia Interface (HDMI) cable
- A 16 GB MicroSD card with Kuiper Linux Image installed
- A USB on the go (OTG) adaptor
- A wireless keyboard and mouse with USB dongle

System Setup

See Figure 8 for the system setup.

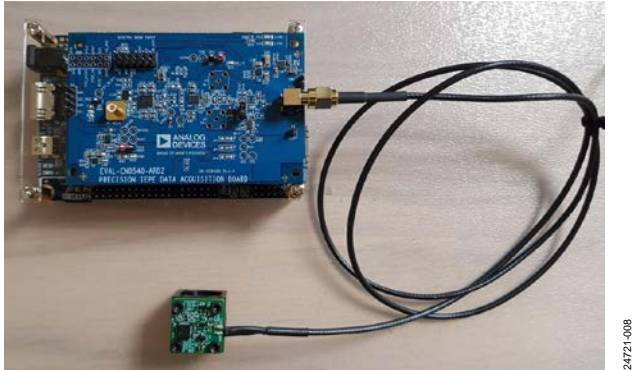

Figure 8. CN-0540 Connected to the DE10-Nano with the CN-0532 Sensor Attached

Getting Started

The following are the required basic steps to test the system and get things up and running.

1. Prepare the microSD card by using the latest software image from the [Analog Devices Kuiper Linux](#) web page. (Note that this step is not shown in Figure 9.)
2. Connect the CN-0540 DAQ board and the DE10-Nano FPGA platform together using the Arduino pin connectors.
3. Connect the CN-0532 to the CN-0540 using an SMA connector. Note that there is no SMA connector on the CN-0532, therefore cut the cable and solder directly to it.
4. Use the screws included with the mounting block, to connect the CN-0532 to one of the sides of the EVAL-XLMOUNT1.
5. On the DE10-Nano, insert the microSD card, connect the USB OTG adaptor, and insert the HDMI cable from the monitor.
6. Apply power to the DE10-Nano via the 5 V dc wall supply included with the DE10-Nano evaluation kit.

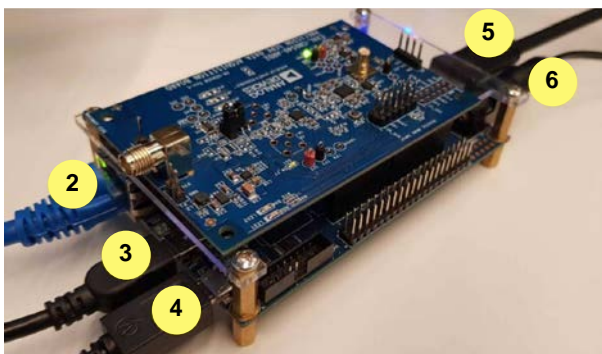

Figure 9. CN-0540 Connected to the DE10-Nano with Peripherals

For complete step by step details on getting the system running by using the DE10-Nano or other supported platforms, see the [CN0549 user guide](#).

Test Results

Take the following steps to test the system:

1. Use the EVAL-XLMOUNT1 to mount the CN-0532 onto a programmable vibration source. Best to use a shaker table or equivalent.
2. Open the CN-0540 IIO-Oscilloscope plugin, calibrate out the sensor offset and write the shift voltage using the calibration routine.
3. Start the vibration source and create a vibration tone at 2 kHz.
4. Go to the capture window on the IIO-Oscilloscope and setup for a frequency domain plot with 16,384 samples and averaging of 3.
5. Hit the **Play** button in the **Capture** window (see the upper left-hand side).
6. Ensure that a 2 kHz tone is in the frequency spectrum, as expected. Note that some other frequency spurs may be seen in the plot due to the vibration source or a nonideal mechanical attachment.

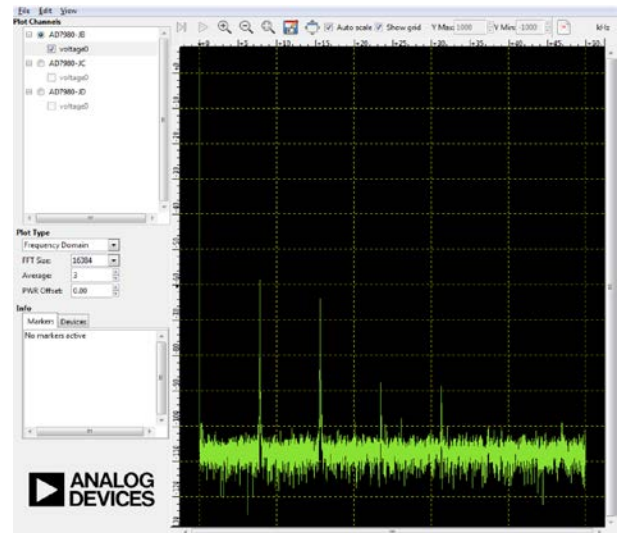

Figure 10. IIO-Oscilloscope Capture Using CN-0532 and CN-0540

For complete step by step details on getting the system running using the DE10-Nano or other supported platforms, see the [CN0549 user guide](#).

LEARN MORE

CN0549 Design Support Package:

<https://www.analog.com/CN0549-DesignSupport>

CN0540 Circuit Note

CN0532 Circuit Note

Thomas Brand. "Demands on Sensors for Future Servicing: Smart Sensors for Condition Monitoring." Technical Articles. Analog Devices.

Data Sheets and Evaluation Boards

CN-0540 Reference Design Board (EVAL-CN0540-ARDZ)

CN-0532 Reference Design Board (EVAL-CN0532-EBZ)

MEMs Mechanical Mounting Block (EVAL-XLMOUNT1)

DE10-Nano FPGA Development Board

REVISION HISTORY

10/2020—Revision 0: Initial Version

I²C refers to a communications protocol originally developed by Philips Semiconductors (now NXP Semiconductors).

(Continued from first page) Circuits from the Lab reference designs are intended only for use with Analog Devices products and are the intellectual property of Analog Devices or its licensors. While you may use the Circuits from the Lab reference designs in the design of your product, no other license is granted by implication or otherwise under any patents or other intellectual property by application or use of the Circuits from the Lab reference designs. Information furnished by Analog Devices is believed to be accurate and reliable. However, Circuits from the Lab reference designs are supplied "as is" and without warranties of any kind, express, implied, or statutory including, but not limited to, any implied warranty of merchantability, noninfringement or fitness for a particular purpose and no responsibility is assumed by Analog Devices for their use, nor for any infringements of patents or other rights of third parties that may result from their use. Analog Devices reserves the right to change any Circuits from the Lab reference designs at any time without notice but is under no obligation to do so.

©2020 Analog Devices, Inc. All rights reserved. Trademarks and registered trademarks are the property of their respective owners.
CN24721-10/20(0)

